

**SYSMAC CS Series
CS1D-ETN21D (100Base-TX)
Ethernet Units for CS1D PLCs**

OPERATION MANUAL

OMRON

CS1D-ETN21D (100Base-TX) Ethernet Units for CS1D PLCs

Operation Manual

Revised June 2008

Notice:

OMRON products are manufactured for use according to proper procedures by a qualified operator and only for the purposes described in this manual.

The following conventions are used to indicate and classify precautions in this manual. Always heed the information provided with them. Failure to heed precautions can result in injury to people or damage to property.

 **DANGER** Indicates an imminently hazardous situation which, if not avoided, will result in death or serious injury.

 **WARNING** Indicates a potentially hazardous situation which, if not avoided, could result in death or serious injury.

 **Caution** Indicates a potentially hazardous situation which, if not avoided, may result in minor or moderate injury, or property damage.

OMRON Product References

All OMRON products are capitalized in this manual. The word “Unit” is also capitalized when it refers to an OMRON product, regardless of whether or not it appears in the proper name of the product.

The abbreviation “Ch,” which appears in some displays and on some OMRON products, often means “word” and is abbreviated “Wd” in documentation in this sense.

The abbreviation “PLC” means Programmable Controller. “PC” is used, however, in some Programming Device displays to mean Programmable Controller.

Visual Aids

The following headings appear in the left column of the manual to help you locate different types of information.

Note Indicates information of particular interest for efficient and convenient operation of the product.

1,2,3... 1. Indicates lists of one sort or another, such as procedures, checklists, etc.

© OMRON, 2004

All rights reserved. No part of this publication may be reproduced, stored in a retrieval system, or transmitted, in any form, or by any means, mechanical, electronic, photocopying, recording, or otherwise, without the prior written permission of OMRON.

No patent liability is assumed with respect to the use of the information contained herein. Moreover, because OMRON is constantly striving to improve its high-quality products, the information contained in this manual is subject to change without notice. Every precaution has been taken in the preparation of this manual. Nevertheless, OMRON assumes no responsibility for errors or omissions. Neither is any liability assumed for damages resulting from the use of the information contained in this publication.

TABLE OF CONTENTS

PRECAUTIONS	xvii
1 Intended Audience	xviii
2 General Precautions	xviii
3 Safety Precautions.....	xviii
4 Operating Environment Precautions	xix
5 Application Precautions	xix
6 Conformance to EC Directives	xxi
SECTION 1	
Features and System Configuration	1
1-1 Ethernet Unit Function Guide	2
1-2 Features	5
1-3 System Configuration	7
1-4 Specifications	11
1-5 Overview of Communications Functions	13
1-6 Nomenclature and Functions	17
1-7 Comparison with CS1W-ETN21.....	19
SECTION 2	
Installation and Initial Setup	21
2-1 Overview of Startup Procedure.....	22
2-2 Main Points in Creating a Duplex Ethernet Network	25
2-3 Switch Settings	26
2-4 Mounting to a PLC	29
2-5 Network Installation	30
2-6 Connecting to the Network	34
2-7 Creating I/O Tables	36
2-8 Enabling Duplex Communications	37
2-9 Unit Setup Procedure	39
2-10 Basic Settings	41
2-11 Communications Test	45
2-12 Replacing an Ethernet Unit.....	47
SECTION 3	
CX-Programmer Unit Setup	51
3-1 Setup	52
3-2 FINS/TCP	53
SECTION 4	
Ethernet Unit Memory Allocations	57
4-1 CIO Area Allocations	58
4-2 DM Area Allocations	65
4-3 Auxiliary Area Data	66

TABLE OF CONTENTS

SECTION 5

Determining IP Addresses	71
5-1 IP Addresses	72
5-2 IP Addresses in FINS Communications	74
5-3 Private and Global Addresses	84

SECTION 6

FINS Communications	89
6-1 Overview of FINS Communications	90
6-2 FINS/UDP Method	92
6-3 FINS/TCP Method	94
6-4 Creating Routing Tables	98
6-5 Using FINS Applications	102
6-6 Communicating between OMRON PLCs	113
6-7 Network Status Performance	129
6-8 Precautions on High Traffic in FINS Communications	130

SECTION 7

FINS Commands Addressed to Ethernet Units	133
7-1 Command Codes and Response Codes	134
7-2 Command/Response Reference	135

SECTION 8

Troubleshooting	161
8-1 Troubleshooting with Indicators	162
8-2 Error Status	163
8-3 Error Log	164
8-4 Troubleshooting Procedures	171
8-5 Troubleshooting with Response Codes	174

Appendices

A Ethernet Network Parameters	177
B Buffer Configuration	179
C TCP Status Transitions	181
D ASCII Characters	183
E Maintenance	185
F Inspections	187
G Using a Memory Card Text File to Set Up an Ethernet Unit	189

Index	199
--------------------	------------

Revision History	205
-------------------------------	------------

About this Manual:

This manual describes the installation and operation of the CS1D-ETN21D Ethernet Unit for CS1D PLCs (100Base-TX) and includes the sections described below.

Please read this manual carefully and be sure you understand the information provided before attempting to install or operate the CS1D Ethernet Unit. Be sure to read the precautions provided in the following section.

Precautions provides general precautions for using the CS1D-ETN21D CS1D Ethernet Units (100Base-TX).

Section 1 introduces the features, describes the system configuration and Unit parts, and provides Unit specifications.

Section 2 explains how to install the Ethernet Unit and make the initial settings required for operation.

Section 3 provides information for setting communications using CX-Programmer.

Section 4 describes the words allocated in the CIO Area and the DM Area for Ethernet Units.

Section 5 explains how to manage and use IP addresses.

Section 6 provides information on communicating on Ethernet Systems and interconnected networks using FINS commands.

Section 7 describes the FINS commands that can be sent to an Ethernet Unit and the responses that are returned by the Ethernet Unit.

Section 8 describes information and procedures that can be used to troubleshoot problems that sometimes occur with Ethernet Unit and Ethernet communications.

Appendices provide information on Ethernet network parameters, the buffer configuration, TCP status transitions, ASCII characters, maintenance, and inspections.

Relevant Manuals

The following table lists CS-series manuals that contain information relevant to CS1D Ethernet Units.

Manual number	Model	Name	Contents
W430	CS1D-ETN21D	Ethernet Units Operation Manual (this manual)	Provides information on operating and installing 100Base-TX Ethernet Units, including details on basic settings and FINS communications. Refer to the <i>Communications Commands Reference Manual</i> (W342) for details on FINS commands that can be sent to CS-series CPU Units when using the FINS communications service.
W420	CS1W-ETN21 CJ1W-ETN21	Ethernet Units Operation Manual Construction of Networks (this manual)	Provides information on operating and installing 100Base-TX Ethernet Units, including details on basic settings and FINS communications. Refer to the <i>Communications Commands Reference Manual</i> (W342) for details on FINS commands that can be sent to CS-series and CJ-series CPU Units when using the FINS communications service.
W421	CS1W-ETN21 CJ1W-ETN21	Ethernet Units Operation Manual Construction of Applications	Provides information on constructing host applications for 100Base-TX Ethernet Units, including functions for sending/receiving mail, socket service, automatic clock adjustment, FTP server functions, and FINS communications.
W343	CS1W-ETN01 CS1W-ETN11 CJ1W-ETN11	Ethernet Units Operation Manual	Describes the installation and operation of the 10Base-5 and 10Base-T Ethernet Units.
W342	CS1G/H-CPU□□H CS1G/H-CPU-□□V1 CS1W-SCU21 CS1W-SCB21/41 CJ1G/H-CPU□□H CJ1G-CPU□□ CJ1W-SCU41	Communications Commands Reference Manual	Describes the C-series (Host Link) and FINS communications commands used when sending communications commands to CS-series and CJ-series CPU Units.
W405	CS1D-CPU□□H CS1D-CPU□□S CS1D-DPL1 CS1D-PA207R	Duplex System Operation Manual	Provides an outline of and describes the design, installation, maintenance, and other basic operations for a Duplex System based on CS1D CPU Units.
W339	CS1G/H-CPU□□H CS1G/H-CPU-□□V1	Programmable Controllers Operation Manual	Provides an outline of, and describes the design, installation, maintenance, and other basic operations for the CS-series PLCs. Information is also included on features, system configuration, wiring, I/O memory allocations, and troubleshooting. Use together with the <i>Programmable Controllers Programming Manual</i> (W394).
W394	CS1G/H-CPU□□H CS1G/H-CPU-□□V1 CJ1G/H-CPU□□H CJ1G-CPU□□	Programmable Controllers Programming Manual	Describes programming, tasks, file memory, and other functions for the CS-series and CJ-series PLCs. Use together with the <i>Programmable Controllers Operation Manual</i> (W339 for CS-series PLCs and W393 for CJ-series PLCs).
W340	CS1G/H-CPU□□H CS1G/H-CPU-□□V1 CJ1G/H-CPU□□H CJ1G-CPU□□	Programmable Controllers Instructions Reference Manual	Describes the ladder diagram programming instructions supported by CS-series and CJ-series PCs. Use together with the <i>Programmable Controllers Operation Manual</i> (W339 for CS-series PLCs and W393 for CJ-series PLCs), and <i>Programmable Controllers Programming Manual</i> (W394).

Manual number	Model	Name	Contents
W414	WS02-CX-□□EV3	CX-Programmer Ver.3.□ Operation Manual	Provides information on how to use the CX-Programmer, a Windows-based programming device, and CX-Net, a Windows-based network configuration tool. Use together with the <i>Programmable Controllers Operation Manual</i> (W339 for CS-series PLCs and W393 for CJ-series PLCs), <i>Programmable Controllers Programming Manual</i> (W394) and the <i>Programmable Controllers Instructions Reference Manual</i> (W340) to perform programming.
W341	CQM1H-PRO01 CQM1-PRO01 C200H-PRO27 + CS1W-KS001	Programming Consoles Operation Manual	Provides information on how to operate the Programming Console. Use together with the <i>Programmable Controllers Operation Manual</i> (W339 for CS-series PLCs and W393 for CJ-series PLCs), <i>Programmable Controllers Programming Manual</i> (W394) and the <i>Programmable Controllers Instructions Reference Manual</i> (W340) to perform programming.
W336	CS1W-SCB21/41 CS1W-SCU21 CJ1W-SCU41	Serial Communications Boards and Serial Communications Units Operation Manual	Accessing the PLC connected to the CX-Programmer via Ethernet or the host computer or other device connected to the Serial Communications Board or Unit. Describes the use of Serial Communications Units and Boards, including details on hardware, software, and standard system protocols.

 **WARNING** Failure to read and understand the information provided in this manual may result in personal injury or death, damage to the product, or product failure. Please read each section in its entirety and be sure you understand the information provided in the section and related sections before attempting any of the procedures or operations given.

Read and Understand this Manual

Please read and understand this manual before using the product. Please consult your OMRON representative if you have any questions or comments.

Warranty and Limitations of Liability

WARRANTY

OMRON's exclusive warranty is that the products are free from defects in materials and workmanship for a period of one year (or other period if specified) from date of sale by OMRON.

OMRON MAKES NO WARRANTY OR REPRESENTATION, EXPRESS OR IMPLIED, REGARDING NON-INFRINGEMENT, MERCHANTABILITY, OR FITNESS FOR PARTICULAR PURPOSE OF THE PRODUCTS. ANY BUYER OR USER ACKNOWLEDGES THAT THE BUYER OR USER ALONE HAS DETERMINED THAT THE PRODUCTS WILL SUITABLY MEET THE REQUIREMENTS OF THEIR INTENDED USE. OMRON DISCLAIMS ALL OTHER WARRANTIES, EXPRESS OR IMPLIED.

LIMITATIONS OF LIABILITY

OMRON SHALL NOT BE RESPONSIBLE FOR SPECIAL, INDIRECT, OR CONSEQUENTIAL DAMAGES, LOSS OF PROFITS OR COMMERCIAL LOSS IN ANY WAY CONNECTED WITH THE PRODUCTS, WHETHER SUCH CLAIM IS BASED ON CONTRACT, WARRANTY, NEGLIGENCE, OR STRICT LIABILITY.

In no event shall the responsibility of OMRON for any act exceed the individual price of the product on which liability is asserted.

IN NO EVENT SHALL OMRON BE RESPONSIBLE FOR WARRANTY, REPAIR, OR OTHER CLAIMS REGARDING THE PRODUCTS UNLESS OMRON'S ANALYSIS CONFIRMS THAT THE PRODUCTS WERE PROPERLY HANDLED, STORED, INSTALLED, AND MAINTAINED AND NOT SUBJECT TO CONTAMINATION, ABUSE, MISUSE, OR INAPPROPRIATE MODIFICATION OR REPAIR.

Application Considerations

SUITABILITY FOR USE

OMRON shall not be responsible for conformity with any standards, codes, or regulations that apply to the combination of products in the customer's application or use of the products.

At the customer's request, OMRON will provide applicable third party certification documents identifying ratings and limitations of use that apply to the products. This information by itself is not sufficient for a complete determination of the suitability of the products in combination with the end product, machine, system, or other application or use.

The following are some examples of applications for which particular attention must be given. This is not intended to be an exhaustive list of all possible uses of the products, nor is it intended to imply that the uses listed may be suitable for the products:

- Outdoor use, uses involving potential chemical contamination or electrical interference, or conditions or uses not described in this manual.
- Nuclear energy control systems, combustion systems, railroad systems, aviation systems, medical equipment, amusement machines, vehicles, safety equipment, and installations subject to separate industry or government regulations.
- Systems, machines, and equipment that could present a risk to life or property.

Please know and observe all prohibitions of use applicable to the products.

NEVER USE THE PRODUCTS FOR AN APPLICATION INVOLVING SERIOUS RISK TO LIFE OR PROPERTY WITHOUT ENSURING THAT THE SYSTEM AS A WHOLE HAS BEEN DESIGNED TO ADDRESS THE RISKS, AND THAT THE OMRON PRODUCTS ARE PROPERLY RATED AND INSTALLED FOR THE INTENDED USE WITHIN THE OVERALL EQUIPMENT OR SYSTEM.

PROGRAMMABLE PRODUCTS

OMRON shall not be responsible for the user's programming of a programmable product, or any consequence thereof.

Disclaimers

CHANGE IN SPECIFICATIONS

Product specifications and accessories may be changed at any time based on improvements and other reasons.

It is our practice to change model numbers when published ratings or features are changed, or when significant construction changes are made. However, some specifications of the products may be changed without any notice. When in doubt, special model numbers may be assigned to fix or establish key specifications for your application on your request. Please consult with your OMRON representative at any time to confirm actual specifications of purchased products.

DIMENSIONS AND WEIGHTS

Dimensions and weights are nominal and are not to be used for manufacturing purposes, even when tolerances are shown.

PERFORMANCE DATA

Performance data given in this manual is provided as a guide for the user in determining suitability and does not constitute a warranty. It may represent the result of OMRON's test conditions, and the users must correlate it to actual application requirements. Actual performance is subject to the OMRON Warranty and Limitations of Liability.

ERRORS AND OMISSIONS

The information in this manual has been carefully checked and is believed to be accurate; however, no responsibility is assumed for clerical, typographical, or proofreading errors, or omissions.

PRECAUTIONS

This section provides general precautions for using the CS1D-ETN21D CS1D Ethernet Units (100Base-TX).

The information contained in this section is important for the safe and reliable application of Ethernet Units. You must read this section and understand the information contained before attempting to set up or operate an Ethernet Unit.

1	Intended Audience	xviii
2	General Precautions	xviii
3	Safety Precautions	xviii
4	Operating Environment Precautions	xix
5	Application Precautions	xix
6	Conformance to EC Directives	xxi
6-1	Applicable Directives	xxi
6-2	Concepts	xxi

1 Intended Audience

This manual is intended for the following personnel, who must also have knowledge of electrical systems (an electrical engineer or the equivalent).

- Personnel in charge of installing FA systems.
- Personnel in charge of designing FA systems.
- Personnel in charge of managing FA systems and facilities.

2 General Precautions

The user must operate the product according to the performance specifications described in the operation manuals.

Before using the product under conditions which are not described in the manual or applying the product to nuclear control systems, railroad systems, aviation systems, vehicles, combustion systems, medical equipment, amusement machines, safety equipment, and other systems, machines, and equipment that may have a serious influence on lives and property if used improperly, consult your OMRON representative.

Make sure that the ratings and performance characteristics of the product are sufficient for the systems, machines, and equipment, and be sure to provide the systems, machines, and equipment with double safety mechanisms.

This manual provides information for programming and operating the Unit. Be sure to read this manual before attempting to use the Unit and keep this manual close at hand for reference during operation.

 **WARNING** It is extremely important that a PLC and all PLC Units be used for the specified purpose and under the specified conditions, especially in applications that can directly or indirectly affect human life. You must consult with your OMRON representative before applying a PLC System to the above-mentioned applications.

3 Safety Precautions

 **WARNING** Do not attempt to take any Unit apart while the power is being supplied. Doing so may result in electric shock.

 **WARNING** Do not touch any of the terminals or terminal blocks while the power is being supplied. Doing so may result in electric shock.

 **WARNING** Do not attempt to disassemble, repair, or modify any Units. Any attempt to do so may result in malfunction, fire, or electric shock.

 **Caution** Execute online editing only after confirming that no adverse effects will be caused by extending the cycle time. Otherwise, the input signals may not be readable.

- Emergency stop circuits, interlock circuits, limit circuits, and similar safety measures must be provided in external control circuits.

 **Caution** Tighten the screws on the terminal block of the AC Power Supply Unit to the torque specified in the operation manual. The loose screws may result in burning or malfunction.

4 Operating Environment Precautions

 **Caution** Do not operate the control system in the following locations:

- Locations subject to direct sunlight.
- Locations subject to temperatures or humidity outside the range specified in the specifications.
- Locations subject to condensation as the result of severe changes in temperature.
- Locations subject to corrosive or flammable gases.
- Locations subject to dust (especially iron dust) or salts.
- Locations subject to exposure to water, oil, or chemicals.
- Locations subject to shock or vibration.

 **Caution** Take appropriate and sufficient countermeasures when installing systems in the following locations:

- Locations subject to static electricity or other forms of noise.
- Locations subject to strong electromagnetic fields.
- Locations subject to possible exposure to radioactivity.
- Locations close to power supplies.

5 Application Precautions

Observe the following precautions when using the Ethernet Unit.

 **WARNING** Always heed these precautions. Failure to abide by the following precautions could lead to serious or possibly fatal injury.

- Always connect to a ground of 100 Ω or less when installing the Units. Not connecting to a ground of 100 Ω or less may result in electric shock.

- Always turn OFF the power supply to the CPU Unit, Slaves, and Communications Units before attempting any of the following. Not turning OFF the power supply may result in malfunction or electric shock.
 - Mounting or dismounting I/O Units, CPU Units, Memory Packs, or Master Units.
 - Assembling the Units.
 - Setting DIP switches or rotary switches.
 - Connecting cables or wiring the system.

 **Caution** Failure to abide by the following precautions could lead to faulty operation of the Ethernet Unit or the system, or could damage the Ethernet Unit. Always heed these precautions.

- Fail-safe measures must be taken by the customer to ensure safety in the event of incorrect, missing, or abnormal signals caused by broken signal lines, momentary power interruptions, or other causes.
- Interlock circuits, limit circuits, and similar safety measures in external circuits (i.e., not in the Programmable Controller) must be provided by the customer.
- Always use the power supply voltages specified in the operation manuals. An incorrect voltage may result in malfunction or burning.
- Take appropriate measures to ensure that the specified power with the rated voltage and frequency is supplied. Be particularly careful in places where the power supply is unstable. An incorrect power supply may result in malfunction.
- Install external breakers and take other safety measures against short-circuiting in external wiring. Insufficient safety measures against short-circuiting may result in burning.
- Make sure that all the Backplane mounting screws, terminal block screws, and cable connector screws are tightened to the torque specified in the relevant manuals. Incorrect tightening torque may result in malfunction.
- Leave the label attached to the Unit when wiring. Removing the label may result in malfunction if foreign matter enters the Unit.
- Remove the label after the completion of wiring to ensure proper heat dissipation. Leaving the label attached may result in malfunction.
- Use crimp terminals for wiring. Do not connect bare stranded wires directly to terminals. Connection of bare stranded wires may result in burning.
- Double-check all wiring and switch settings before turning ON the power supply. Incorrect wiring may result in burning.
- Wire all connections correctly.
- Mount Units only after checking terminal blocks and connectors completely.
- Make sure that the terminal blocks, expansion cables, and other items with locking devices are locked in place.
- When transporting the Unit, use special packing boxes and protect it from being exposed to excessive vibration or impacts during transportation.
- Check the user program for proper execution before actually running it on the Unit. Not checking the program may result in unexpected operation.

- Observe the following precautions when wiring the communications cable.
 - Separate the communications cables from the power lines or high-tension lines.
 - Do not bend the communications cables past their natural bending radius.
 - Do not pull on the communications cables.
 - Do not place heavy objects on top of the communications cables.
 - Always lay communications cable inside ducts.
 - Use appropriate communications cables.
- Before touching a Unit, be sure to first touch a grounded metallic object in order to discharge any static build-up. Not doing so may result in malfunction or damage.
- Confirm that no adverse effect will occur in the system before attempting any of the following. Not doing so may result in an unexpected operation.
 - Changing the operating mode of the PLC (including the setting of the startup mode).
 - Force-setting/force-resetting any bit in memory.
 - Changing the present value of any word or any set value in memory.

6 Conformance to EC Directives

6-1 Applicable Directives

- EMC Directives
- Low Voltage Directive

6-2 Concepts

EMC Directives

OMRON devices that comply with EC Directives also conform to the related EMC standards so that they can be more easily built into other devices or the overall machine. The actual products have been checked for conformity to EMC standards (see the following note). Whether the products conform to the standards in the system used by the customer, however, must be checked by the customer.

EMC-related performance of the OMRON devices that comply with EC Directives will vary depending on the configuration, wiring, and other conditions of the equipment or control panel on which the OMRON devices are installed. The customer must, therefore, perform the final check to confirm that devices and the overall machine conform to EMC standards.

Note Applicable EMS (Electromagnetic Susceptibility) and EMI (Electromagnetic Interference) Standards in the EMC (Electromagnetic Compatibility) standards are as follows:

Unit/Board	EMS	EMI
CS1D-ETN21D	EN61000-6-2	EN61000-6-4 (Radiated emission: 10-m regulations)

Low Voltage Directive

Always ensure that devices operating at voltages of 50 to 1,000 V AC and 75 to 1,500 V DC meet the required safety standards for the PLC (EN61131-2).

SECTION 1

Features and System Configuration

This section introduces the features, describes the system configuration and Unit parts, and provides Unit specifications.

1-1	Ethernet Unit Function Guide	2
1-1-1	Overall System Configuration Example	2
1-1-2	Determining the Objectives	3
1-2	Features	5
1-3	System Configuration	7
1-3-1	System Configuration	7
1-3-2	Devices Required for Constructing a Network	7
1-3-3	Setup Area and Related Peripheral Devices	7
1-4	Specifications	11
1-4-1	General Specifications	11
1-4-2	Dimensions	12
1-4-3	Software Configuration	12
1-5	Overview of Communications Functions	13
1-5-1	FINS Communications Service	13
1-5-2	Creating a Duplex Network	14
1-6	Nomenclature and Functions	17
1-6-1	Component Names	17
1-6-2	Indicators	18
1-7	Comparison with CS1W-ETN21	19

1-1 Ethernet Unit Function Guide

1-1-1 Overall System Configuration Example

The following diagram shows an example of an overall system configuration using CS1D Ethernet Units.

Duplex Ethernet Network

A duplex Ethernet network can be created by mounting two CS1D-ETN21D Ethernet Units as a set in a CS1D PLC.

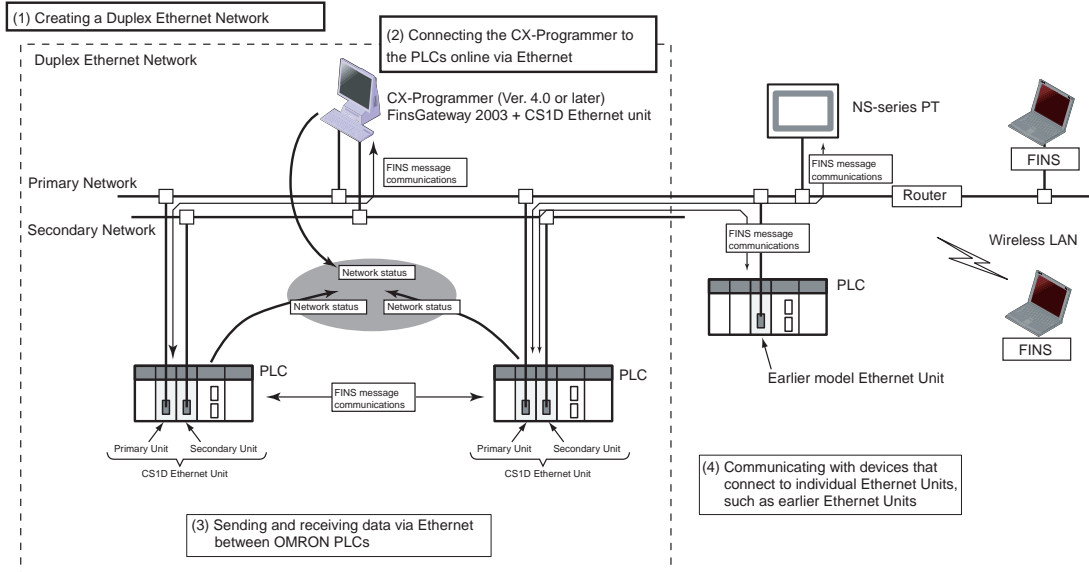

Non-duplex Ethernet Network

A non-duplex Ethernet network can be created by mounting one CS1D-ETN21D Ethernet Unit in a CS1D PLC.

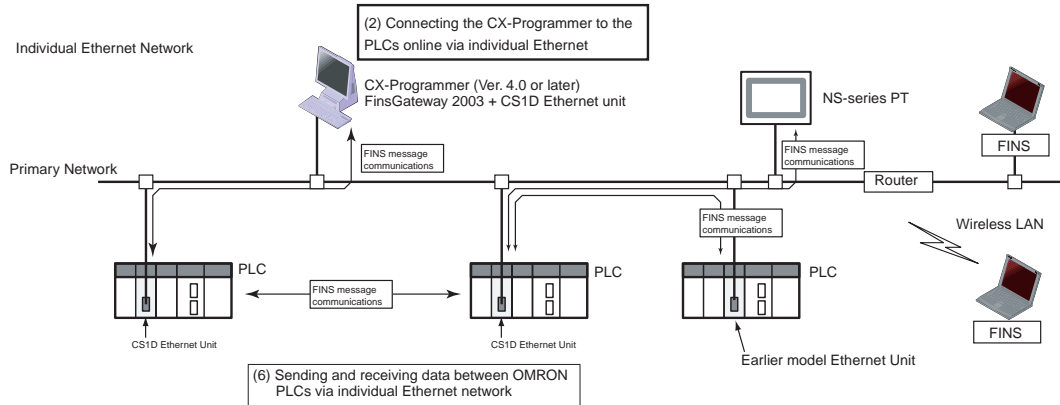

1-1-2 Determining the Objectives

Connecting the CX-Programmer to PLCs Online via Ethernet

Creating a Duplex Ethernet Network

Use two CS1D Ethernet Units as a set.

The main Ethernet network is called the primary network and the Ethernet Unit connected to the primary network is called the Primary Unit. The duplex Ethernet network is called the secondary network and the Ethernet Unit connected to the secondary network is called the Secondary Unit.

Special communications data, called the network status, is broadcast at fixed intervals in order to manage the entry/withdrawal of communications nodes in each network. Nodes can be duplexed in the Ethernet network only if they are within the same segment and can send and receive the broadcast network status data.

Connecting the CX-Programmer and a PLC Online in a Duplex Ethernet Network

To create a redundant CX-Programmer connection, use FinsGateway Version 2003 or later as the computer's middleware and install the Ethernet Unit driver (ETN_UNIT) for the duplex Ethernet network.

Use the UDP/IP version of the FINS communications service (hereafter referred to as FINS/UDP) as the communications method. When there is a failure in part of the primary network's communications path in the FINS communications service, the system automatically switches to the secondary network path to replace the failed part of the primary network only. It is possible that communications data will be lost until communications are rerouted over the failed part of the primary network, but this data will be sent again by the CX-Programmer's timeout and retry functions.

Communicating between OMRON PLCs in a Duplex Ethernet Network

Applications can be constructed using the SEND, RECV, and CMND ladder programming instructions.

Use the UDP/IP version of the FINS communications service (hereafter referred to as FINS/UDP) as the communications method. When there is a failure in part of the primary network's communications path in the FINS communications service, the system automatically switches to the secondary network path to replace the failed part of the primary network only. It is possible that communications data will be lost until communications are rerouted over the failed part of the primary network, but this data will be sent again if the correct timeout and retry function settings are made in the SEND, RECV, and CMND instructions.

We recommend allocating fixed IP addresses in computers connected to the duplex Ethernet networks. If a protocol such as DHCP is being used, which changes IP addresses, it is difficult to switch to the secondary network when a failure occurs.

Communicating with Non-duplex Ethernet Nodes such as Earlier Ethernet Units

Connecting within the Same Segment

Use the UDP/IP version of the FINS communications service (i.e., FINS/UDP). FINS/UDP is supported by many OMRON products and is compatible with earlier Ethernet Units (CS1W-ETN01/ETN11 and CJ1W-ETN11). The CX-Programmer can be connected and used with FINS/UDP even if personal computer middleware (FinsGateway) is not used. FinsGateway (any version) can also be used together with the CX-Programmer.

Connecting through Multiple Segments

Use the TCP/IP version of the FINS communications service (i.e., FINS/TCP). FINS/TCP is a new function supported by these Ethernet Units (CS1D-ETN21 D). It provides automatic recovery at the TCP/IP layer from communications errors (such as packet loss) that occur during multilevel routing. To use the CX-Programmer with FINS/TCP, use FinsGateway (version 2003 or higher) as personal computer middleware.

Using Media with Unreliable Connections, Such as a Wireless LAN

Use the TCP/IP version of the FINS communications service (i.e., FINS/TCP). FINS/TCP is a new function supported by these Ethernet Units (CS1W-ETN21 and CJ1W-ETN21). It provides automatic recovery at the TCP/IP layer from communications errors (such as packet loss) resulting from unreliable connections. To use the CX-Programmer with FINS/TCP, use FinsGateway (version 2003 or higher) as personal computer middleware.

Connecting from a Personal Computer with a Dynamic Private IP Address

Depending on whether or not the connection will be within the same segment, either use an IP address conversion method for dynamic IP addresses in the UDP/IP version of the FINS communications service or use the TCP/IP version of the FINS communications service.

It is possible to connect online to a PLC using the CX-Programmer from a computer serving as a temporarily connected node or a permanent DHCP client.

To use the CX-Programmer with FINS/TCP, use FinsGateway (version 2003 or higher) as personal computer middleware.

Connecting within the Same Segment

Use the UDP/IP version of the FINS communications service (i.e., FINS/UDP). FINS/UDP is supported by many OMRON products and is compatible with earlier Ethernet Units (CS1W-ETN01/ETN11 and CJ1W-ETN11). The CX-Programmer can be connected and used with FINS/UDP even if personal computer middleware (FinsGateway) is not used. FinsGateway (any version) can also be used together with the CX-Programmer.

Connecting through Multiple Segments

Use the TCP/IP version of the FINS communications service (i.e., FINS/TCP). FINS/TCP is a new function supported by these Ethernet Units (CS1W-ETN21 and CJ1W-ETN21). It provides automatic recovery at the TCP/IP layer from communications errors (such as packet loss) that occur during multilevel routing. To use the CX-Programmer with FINS/TCP, use FinsGateway (version 2003 or higher) as personal computer middleware.

Using Media with Unreliable Connections, Such as a Wireless LAN

Use the TCP/IP version of the FINS communications service (i.e., FINS/TCP). FINS/TCP is a new function supported by these Ethernet Units (CS1W-ETN21 and CJ1W-ETN21). It provides automatic recovery at the TCP/IP layer from communications errors (such as packet loss) resulting from unreliable connections. To use the CX-Programmer with FINS/TCP, use FinsGateway (version 2003 or higher) as personal computer middleware.

Connecting the CX-Programmer and a PLC Online in a Non-duplex Ethernet Network

Communicating between OMRON PLCs in a Non-duplex Ethernet Network**Connecting from a Personal Computer with a Dynamic Private IP Address**

Depending on whether or not the connection will be within the same segment, either use an IP address conversion method for dynamic IP addresses in the UDP/IP version of the FINS communications service or use the TCP/IP version of the FINS communications service.

It is possible to connect online to a PLC using the CX-Programmer from a computer serving as a temporarily connected node or a permanent DHCP client.

To use the CX-Programmer with FINS/TCP, use FinsGateway (version 2003 or higher) as personal computer middleware.

Connecting within the Same Segment

Use the UDP/IP version of the FINS communications service (i.e., FINS/UDP). Construct applications using the SEND, RECV, and CMND instructions in the ladder program. FINS/UDP is supported by many OMRON products and is compatible with earlier Ethernet Units (CS1W-ETN01/ETN11 and CJ1W-ETN11).

In comparison to FINS/TCP, FINS/UDP's protocol processing is simpler and has some performance advantages. Another feature of FINS/UDP is the support of broadcast transmissions. On the other hand, applications such as retry routines must be created for FINS/UDP.

Connecting through Multiple Segments

Use the TCP/IP version of the FINS communications service (i.e., FINS/TCP). Construct applications using the SEND, RECV, and CMND instructions in the ladder program. FINS/TCP is a new function supported by these Ethernet Units (CS1W-ETN21 and CJ1W-ETN21). It provides automatic recovery at the TCP/IP layer from communications errors (such as packet loss) that occur during multilevel routing.

1-2 Features

Constructing Duplex Ethernet Networks (Duplex FINS Communications)

The CS1D-ETN21D supports duplex Ethernet networks, which could not be created with earlier Ethernet Unit models. Duplex Ethernet networks provide the following functions.

Duplex Ethernet Networks (Duplex FINS Communications)

Two CS1D-ETN21D Ethernet Units can be mounted in a CS1D PLC to create a main system (Primary Unit and primary network) and a redundant system (Secondary Unit and secondary network).

Monitoring the Entry/Withdrawal of Nodes

Network status information is delivered periodically between the communicating nodes to monitor the entry and withdrawal of nodes in the network. The entry/withdrawal status can be read as the network participation status using the ladder program or the CX-Programmer.

Automatic Switching of FINS Message Communications

The Secondary Unit will be used when the Primary Unit can't be used for some reason (failure of the Unit, disconnected cable, online unit replacement, etc.). If FINS message applications have been created that communicate through the primary network, the CS1D CPU Unit and CS1D Ethernet Unit will automatically switch to the Secondary Unit as the destination node for messages. It is possible for FINS messages to be lost when operation switches to the Secondary Unit, but a lapse in message communications can be avoided by using timeout monitoring and retry functions in the FINS message application.

Connecting with Earlier Non-duplex Ethernet Devices (FINS Messages)

It is possible to use non-duplex Ethernet nodes in a duplex Ethernet network. Normally, non-duplex Ethernet nodes are connected to the primary network. The communications path is not redundant between non-duplex Ethernet nodes, so the automatic switching function cannot be used between these nodes.

FINS Message Communications

FINS message communications are compatible and interchangeable with earlier non-duplex Ethernet Units.

- Expandable number of nodes (up to 254 nodes max.)
- FINS/UDP protocol, which uses UDP/IP
- FINS/TCP protocol, which uses TCP/IP (Up to 16 simultaneous connections are allowed and the keep-alive function is supported.)

Network Connection to Controller Link

It is also possible to interconnect the Ethernet information network with the Controller Link control network (using the FINS communications service functions). This feature allows a PLC in the Ethernet network to monitor a PLC in the Controller Link network. Conversely, a PLC in the Controller Link network can read or write data in a PLC in the Ethernet network.

Full Set of Troubleshooting Functions

A variety of functions are available so that network problems can be identified and corrected quickly.

- Self-diagnostic functions at startup
- Check connections with other nodes using the PING command.
- Check connections with other nodes using the internode test.
- Error log function records error information when errors occur.
- E-mail notification of error events
- Online replacement of Units

1-3 System Configuration

1-3-1 System Configuration

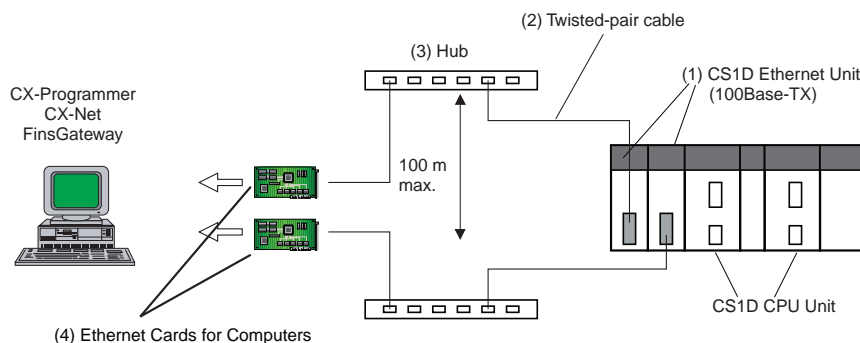

1-3-2 Devices Required for Constructing a Network

The basic configuration for a 100Base-TX Ethernet System consists of one hub to which nodes are attached in star form using twisted-pair cable.

The devices shown in the following table are required to configure a network with 100Base-TX-type CS1D-ETN21D Ethernet Units, so prepare them in advance.

Network device	Contents
(1) CS-series CS1D Ethernet Units (CS1D-ETN21D)	These Ethernet Units are Communications Units that connect a CS-series CS1D PLC to 100Base-TX Ethernet networks. (They can also be used as 10Base-T.)
(2) Twisted-pair cable	This is twisted-pair cable for connecting 100Base-TX-type Ethernet Units to the hub, with an RJ45 Modular Connector at each end. Use a category 3, 4, 5, or 5e UTP (unshielded twisted-pair) or STP (shielded twisted-pair) cable.
(3) Hub	This is a relay device for connecting multiple nodes in a star LAN.
(4) Ethernet cards for computers	Install an Ethernet card in the computer when necessary, e.g., when creating a duplex Ethernet network.

Recommended Hubs

For details on recommended devices for constructing a network, refer to 2-5 *Network Installation*.

1-3-3 Setup Area and Related Peripheral Devices

Making I/O Table Settings (with the CX-Programmer or Programming Console)

Make the necessary I/O table settings for the CS1D-ETN21D Ethernet Unit as a CPU Bus Unit. Make the settings with a Programming Console or CX-Programmer Version 4.0 or later (the I/O Table window).

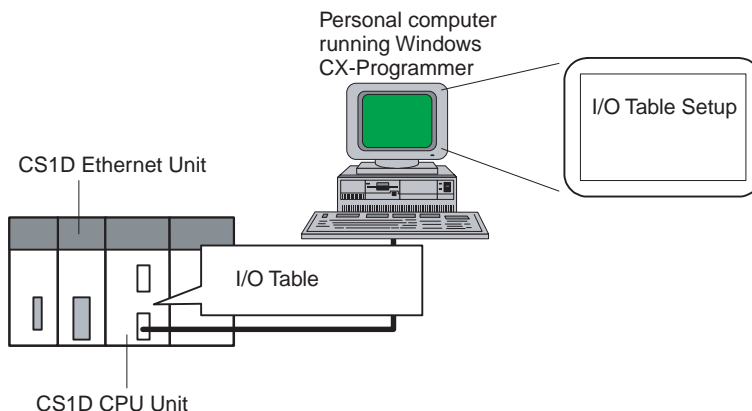

Making PLC Setup Settings (with the CX-Programmer or Programming Console)

When using the CS1D-ETN21D Ethernet Units in a duplex Ethernet network, set the Ethernet Unit as a primary or Secondary Unit. as a CPU Bus Unit. Make the settings with a Programming Console or CX-Programmer Version 4.0 or later (the **Comms Unit Duplex** Tab of the *PLC Setup Window*).

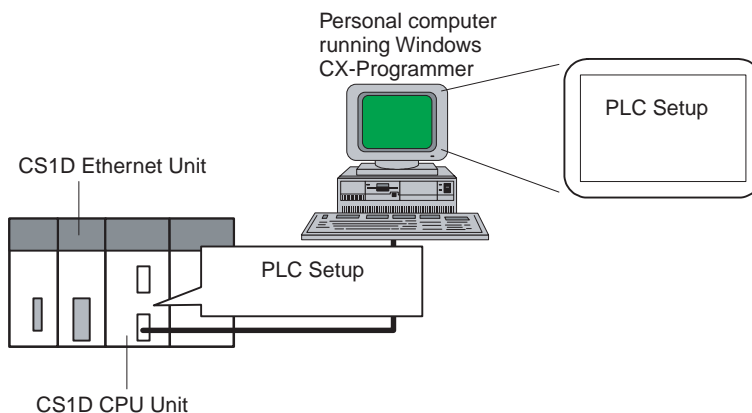

Making Settings in the CPU Bus Unit System Setup Area (with the CX-Programmer)

For the Ethernet Unit to function as a node on an Ethernet network, make the settings, as required, in the CPU Bus Unit System Setup Area allocated in non-volatile memory in the CPU Unit.

Use the CX-Programmer to make the settings (by connecting online from the I/O Table Window, selecting the Ethernet Unit, and then selecting *Unit Setup*). Each time the Ethernet Unit is turned ON or restarted, it reads and uses the contents of the CPU Bus Unit System Setup Area as the settings for the communications services.

Use the CX-Programmer Version 4.0 or later to make the settings for a CS1D-ETN21D Ethernet Unit. It is also possible to make the settings for a CS1D-ETN21D without the CX-Programmer using a Programming Console and a text file stored in a Memory Card. (Refer to *Appendix F Inspections* for details on making settings from a text file in the Memory Card.)

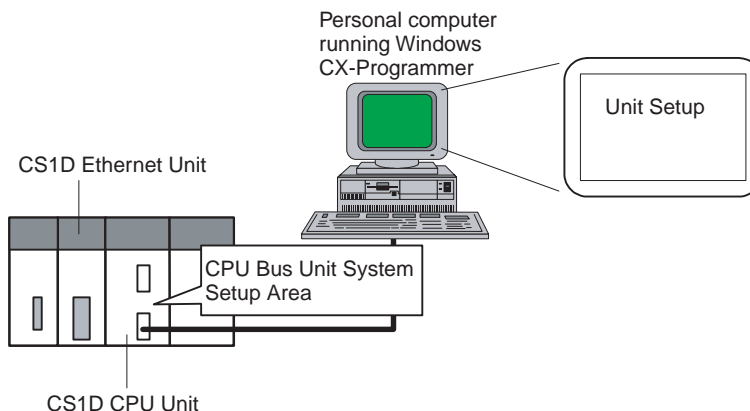

Making Settings in the Routing Table Area (with CX-Net)

OMRON Communications Units use OMRON's original FINS network system. Make the settings for the FINS network address and the relay path, as required, in the Routing Table Area allocated to the non-volatile memory in the CPU Unit.

Use CX-Net to make the settings. (CX-Net is software that comes with the CX-Programmer and is automatically installed when the CX-Programmer is installed.) Each time the Ethernet Unit is turned ON or restarted, it reads and uses the contents of the Routing Table Area as the settings for FINS network. When using a duplex Ethernet network, set different network addresses for the primary and Secondary Units.

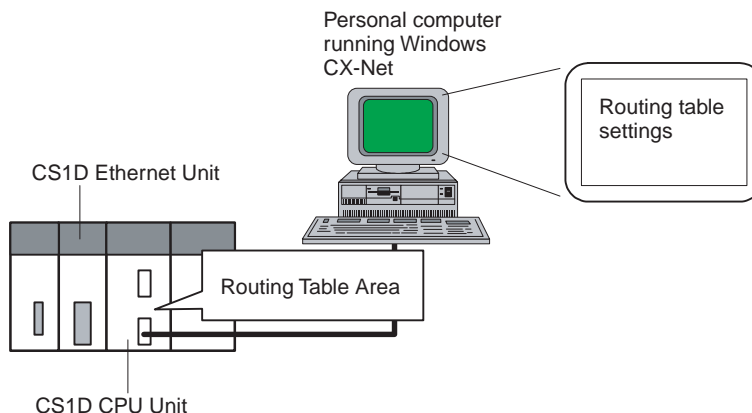

Middleware for FINS Communications Applications on a Personal Computer (FinsGateway)

FinsGateway can be used as middleware when constructing communications applications on a personal computer for a FINS network, using Visual C++ or Visual BASIC. The CX-Programmer and CX-Net can also be connected online through FinsGateway. When FINS/UDP is used in the FINS communications service, all versions of FinsGateway can be used.

When FINS/TCP is used in the FINS communications service, only FinsGateway Version 2003 or higher can be used.

When installing two Ethernet cards in the computer to use the duplex network functions, an Ethernet Unit (ETN_UNIT) that supports the duplex network functions must be included in the FinsGateway Version 2003.

FinsGateway Version 2003 or later must be used in order to connect the CX-Programmer or CX-Net online through FINS/TCP.

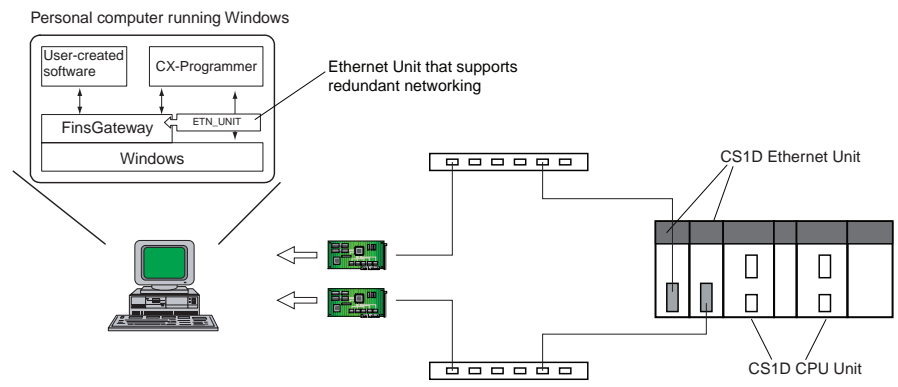

1-4 Specifications

1-4-1 General Specifications

CS-series CS1D Ethernet Unit

Item		Specifications	
Model number		CS1D-ETN21D	
Type		100Base-TX (Can be used as 10Base-T)	
Applicable PLCs		CS-series CS1D PLCs	
Unit classification		CS-series CPU Bus Unit	
Mounting location		CPU Rack or Expansion Rack	
Number of Units that can be mounted		4 max. (including Expansion Racks) Or 4 sets (using 2 Units as 1 set for redundant networking), including Expansion Racks	
Transfer specifications	Media access method	CSMA/CD	
	Modulation method	Baseband	
	Transmission paths	Star form	
	Baud rate	100 Mbit/s (100Base-TX)	10 Mbit/s (10Base-T)
	Transmission media	Unshielded twisted-pair (UDP) cable Categories: 5, 5e Shielded twisted-pair (STP) cable Categories: 100 Ω at 5, 5e	Unshielded twisted-pair (UDP) cable Categories: 3, 4, 5, 5e Shielded twisted-pair (STP) cable Categories: 100 Ω at 3, 4, 5, 5e
	Transmission distance	100 m (distance between hub and node)	
	Number of cascade connections	2	4
Current consumption (Unit)		380 mA max. at 5 V DC	
Vibration resistance		Conforms to JIS 0040. 10 to 57Hz: 0.075-mm amplitude, 57 to 150 Hz: acceleration 9.8 m/s ² in X, Y, and Z directions for 80 minutes each (sweep time: 8 minutes × 10 sweeps = 80 minutes)	
Shock resistance		Conforms to JIS 0041. 147m/s ² , 3 times each in X, Y, and Z directions	
Ambient operating temperature		0 to 55°C	
Ambient humidity		10% to 90% (with no condensation)	
Atmosphere		Must be free of corrosive gas.	
Ambient storage temperature		-20 to 75°C	
Weight		200 g max.	
Dimensions		35 × 130 × 101 mm (W × H × D)	

1-4-2 Dimensions

CS1D-ETN21D

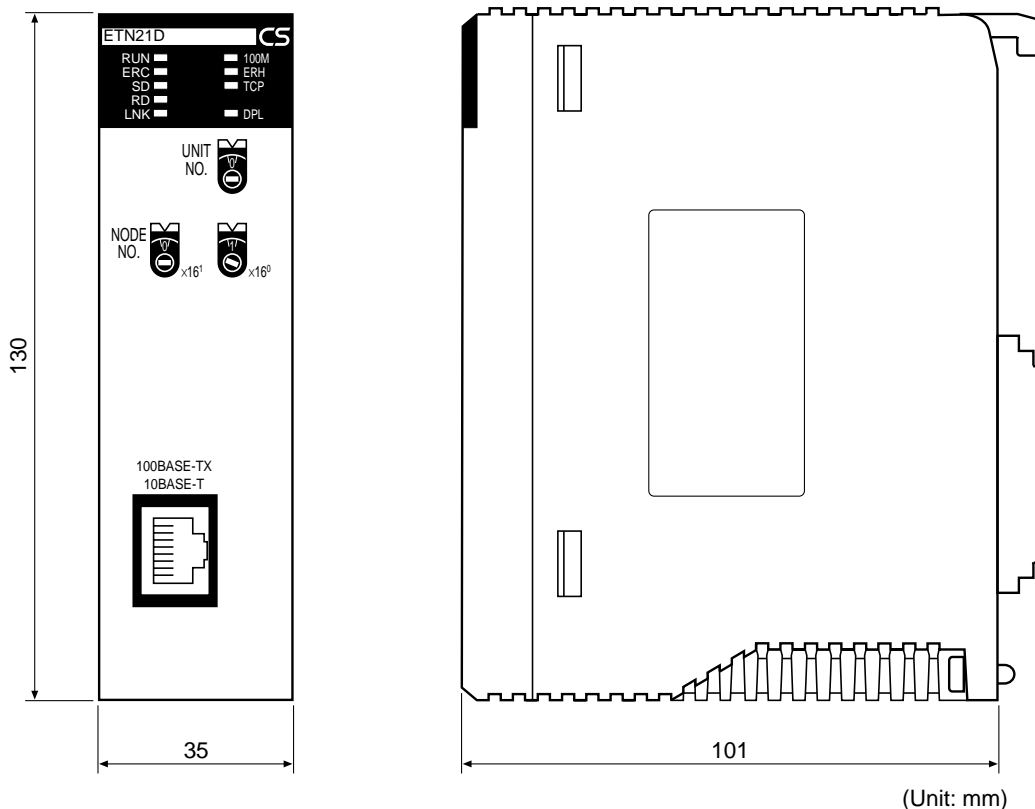

1-4-3 Software Configuration

The software supported by the Ethernet Unit runs in the layers shown in the following diagram. The components that form the various layers are defined below the diagram.

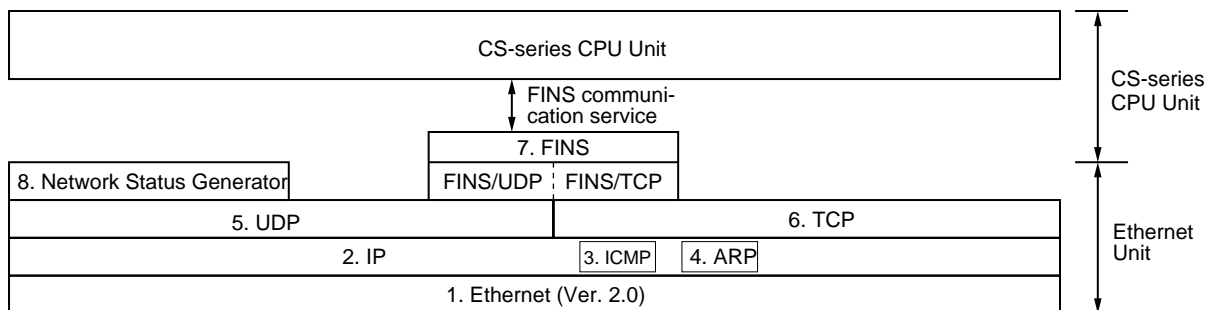

- 1,2,3...**
1. Ethernet (Ver. 2.0)
The Version 2.0 Ethernet frame format is used for communications.
 2. IP (Internet Protocol)
Transfers datagrams to destination nodes using IP addresses.
 3. ICMP (Internet Control Message Protocol)
Supports IP communications by signalling errors in data transfers.
 4. ARP (Address Resolution Protocol)
Determines the Ethernet address (i.e., physical address) by broadcasting based on the target IP address.

5. UDP (User Datagram Protocol)
 Performs data communications with datagram units. Data resends, priority control, flow control, and other measures to ensure communications reliability are not performed for UDP communications, so the transmitted data may not arrive at the destination node. To increase reliability, it is necessary to program special measures into the user applications.
6. TCP (Transmission Control Protocol)
 Performs communications after establishing a connection (i.e., a virtual circuit) with the destination node, providing a highly reliable communications service.
7. FINS (Factory Interface Network Service)
 A protocol that sends messages between PLCs on any of various OMRON FA networks. To ensure that transmitted messages arrive at the destination node, it is necessary to program special measures such as retry processing into the user's applications.
8. Network Status Generator
 A proprietary OMRON protocol that monitors the entry/withdrawal of nodes in a duplex Ethernet system.

1-5 Overview of Communications Functions

1-5-1 FINS Communications Service

Basic Functions

FINS commands can be sent to or received from other PLCs or computers on the same Ethernet network by executing SEND(090), RECV(098), or CMND(490) instructions in the ladder diagram program. This enables various control operations such as the reading and writing of I/O memory between PLCs, mode changes, and file memory operations.

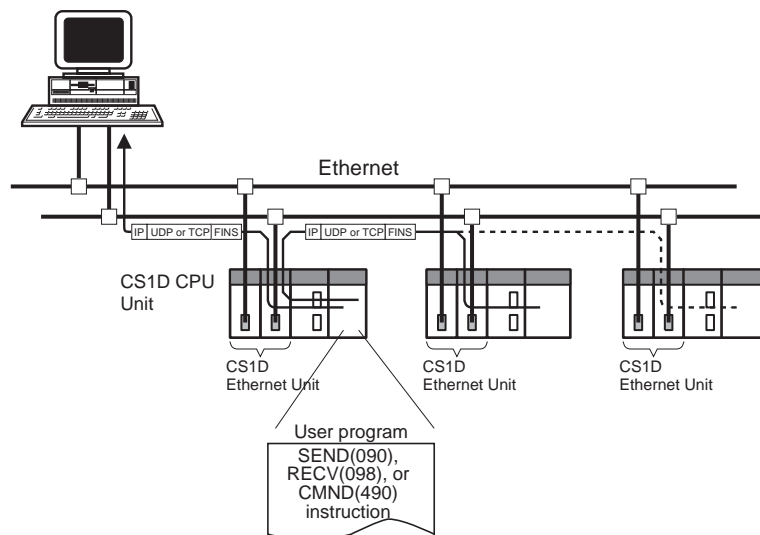

Executing, from the host computer, FINS commands with UDP/IP or TCP/IP headers enables various control operations, such as the reading and writing of I/O memory between PLCs, mode changes, and file memory operations.

For example, it is possible to connect online via Ethernet from FINS communications applications such as the CX-Programmer, and to perform remote programming and monitoring. (See note.)

Note FinsGateway Version 2003 or higher is required to use TCP/IP.

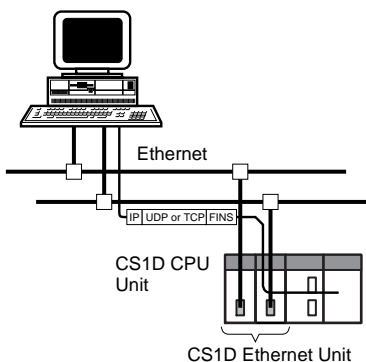

The FINS gateway function enables access to PLCs on not only the same Ethernet network but on various other networks, including SYSMAC LINK and Controller Link.

1-5-2 Creating a Duplex Network

Creating a Duplex Ethernet Network (Redundant FINS Communications)

Two CS1D-ETN21D Ethernet Units can be used in a CS1D PLC as a set, with one used in the main system (Primary Unit and primary network) and the other used in the redundant system (Secondary Unit and secondary network).

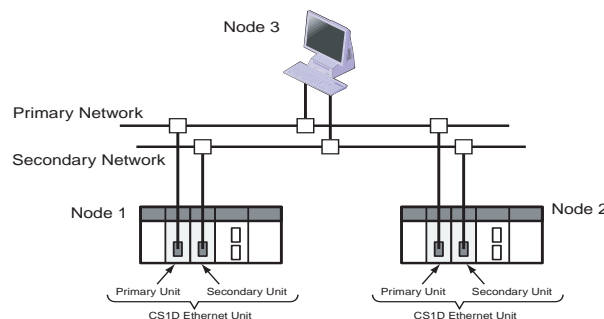

Monitoring the Entry/Withdrawal of Nodes

The network status information is periodically delivered between nodes in a broadcast transmission and the entry/withdrawal status of the nodes is monitored. The entry/withdrawal status information is used in the FINS message communications' automatic switching function. Consequently, the range of the duplex Ethernet network is limited to nodes that can be reached by the broadcast transmissions. The network cannot be duplicated beyond this range.

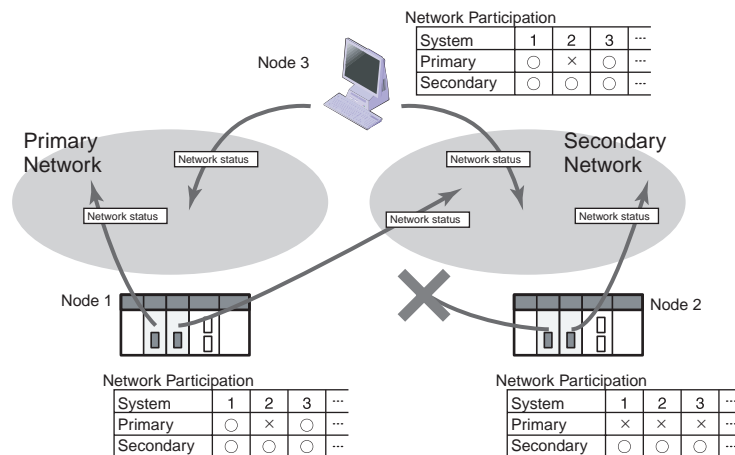

The entry/withdrawal status can be read as the network participation status using the ladder program or the CX-Programmer.

Automatic Switching of FINS Message Communications

The Secondary Unit will be used when the Primary Unit can't be used as the source of FINS messages for some reason (failure of the Unit, disconnected cable, hot-swapping of the Unit, etc.). If FINS message applications have been created that communicate through the primary network, the CS1D CPU Unit and CS1D Ethernet Unit will automatically switch to the Secondary Unit as the destination node for messages.

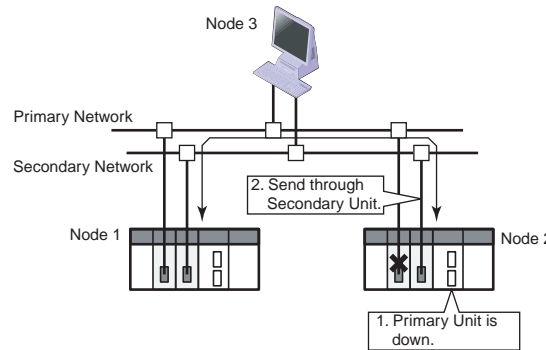

Also, if the destination node for a FINS message is withdrawn from the network, the CS1D CPU Unit and CS1D Ethernet Unit will automatically switch to the secondary node as the destination node for the message.

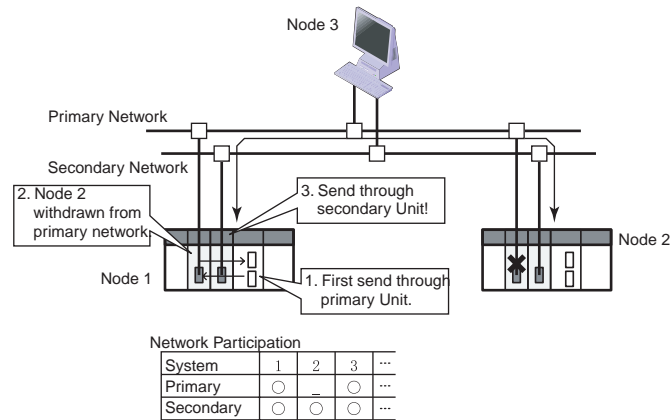

It is possible for FINS messages to be lost when operation switches to the secondary system. Use timeout monitoring and retry functions in the application in order to prevent lapses in FINS message communications.

Connecting with Earlier Non-duplex Ethernet Nodes (FINS Messages)

Earlier models of Ethernet nodes are not equipped with the function that sends and receives the network status information. Consequently, the earlier Ethernet nodes are always withdrawn from the network from the viewpoint of the duplex Ethernet nodes. The earlier nodes are not recognized in either the primary or secondary network, so in this case FINS messages specified in the primary network are not automatically switched and are sent in the primary network. Since the messages are still sent in the primary network, non-duplex Ethernet nodes can be combined with duplex Ethernet nodes in the primary network.

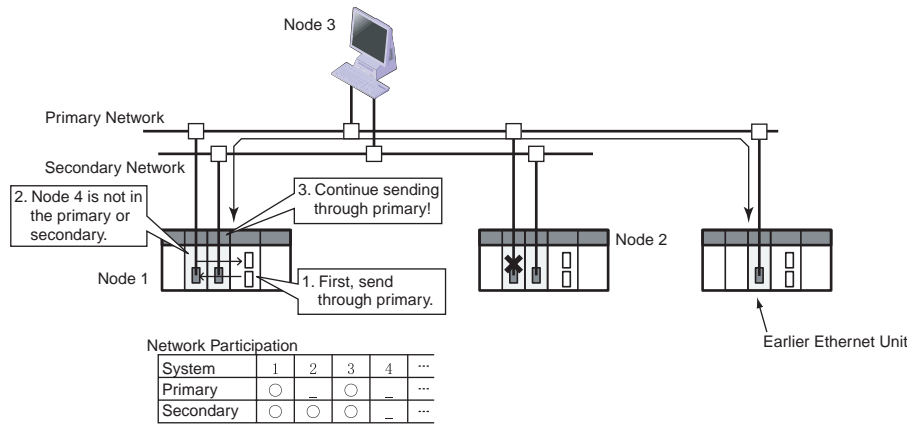

1-6 Nomenclature and Functions

This section describes Ethernet Unit component names, settings, and LED indicators.

1-6-1 Component Names

CS-series Ethernet Units

CS1D-ETN21D (100Base-TX)

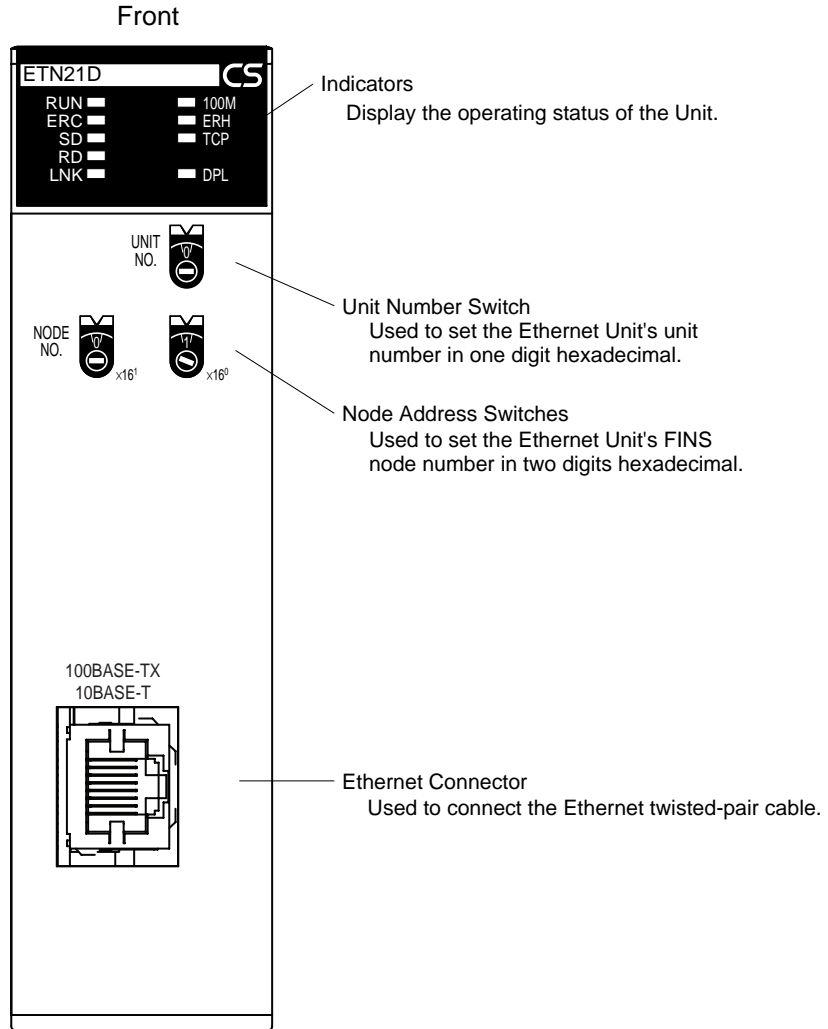

Each communications device connected to the Ethernet network is allocated a unique Ethernet address. For the Ethernet Unit, this Ethernet address is shown on the right side of the Unit as a 12-digit hexadecimal number.

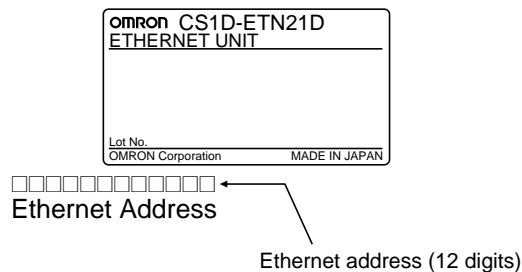

- Note**
1. The Ethernet address can also be checked using the FINS command, CONTROLLER DATA READ. For details, refer to 7-2-2 CONTROLLER DATA READ on page 136.
 2. An IP address label is provided with the Unit. Writing the IP address and the subnet mask on this label and then attaching it to the front of the Unit allows the IP address and subnet mask to be easily confirmed.

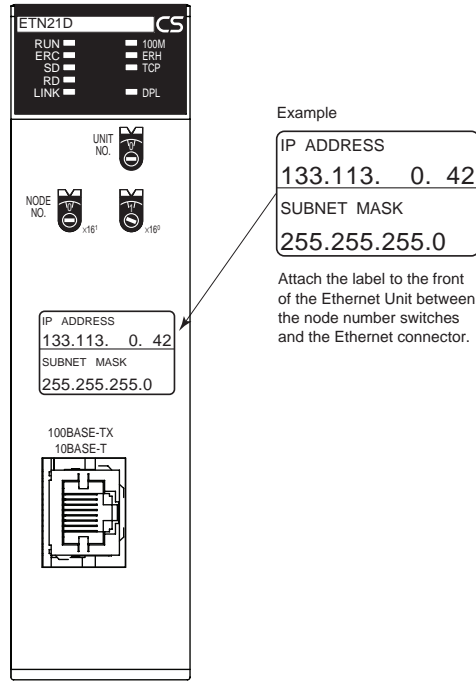

1-6-2 Indicators

The status of the indicators show the operating status of the Ethernet Unit, as shown below.

CS1D-ETN21D
(100Base-TX)

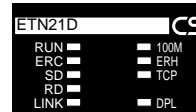

Indicator	Color	Status	Meaning
RUN	Green	Not lit	Operation stopped Hardware error
		Lit	Normal operation
100M (Transfer speed)	Green	Not lit	10 Mbps (10Base-T)
		Lit	100 Mbps (100Base-TX)
ERC (Ethernet Unit error)	Red	Not lit	Unit normal
		Lit	Node address not between 1 and 254 A hardware (e.g., internal memory) error has occurred.

Indicator	Color	Status	Meaning
ERH (CPU Unit error)	Red	Not lit	CPU Unit normal
		Lit	An error has occurred at the CPU Unit. There is an error in the I/O table, unit number, unit setup, or routing table settings. An illegal IP address has been set. With automatic address generation, the rightmost two digits of the IP address do not match the node address.
		Flashing	A file access error occurred when making settings from a text file stored in the Memory Card.
SD (Send Data)	Yellow	Not lit	Not sending data (ready to send)
		Lit	Sending data
RD (Receive Data)	Yellow	Not lit	Not receiving data (ready to receive)
		Lit	Receiving data
LNK (Link status)	Yellow	Not lit	Link not established between hubs.
		Lit	Link established between hubs.
TCP (TCP socket in use)	Yellow	Not lit	None of the eight TCP sockets provided for socket services is in use.
		Lit	At least one of the eight TCP sockets provided for socket services is in use.
DPL (Duplex network operation)	Yellow	Not lit	Duplex (redundant) network operation stopped.
		Lit	Duplex network is operating through the Primary Unit.
		Flashing	Duplex network is operating through the Secondary Unit.

1-7 Comparison with CS1W-ETN21

Item	Previous models	New models
Model number	CS1W-ETN21 CJ1W-ETN21	CS1D-ETN21D
Duplex (redundant) network operation (Redundant FINS message communications)	Not Possible	Possible
PLC maintenance via the Internet	Can send commands (including FINS commands) by e-mail over the Internet from a personal computer to the PLC (using the mail receive function).	
	Possible with the mail receive function.	Not Possible
Server specification	Specification by IP address or by host name (using the DNS client function)	Not Possible

Item		Previous models	New models
Communi- cations ser- vice	FINS commu- nica- tions service	Automatic IP address acquisition (DHCP client) by personal computer	A computer automatically acquiring IP addresses can send commands to the PLC and receive responses. (UDP/IP: By automatic generation (dynamic) IP address conversion method; TCP/IP: Automatic)
		FINS communications with personal computers without fixed node addresses	Possible (with Automatic allocation by Ethernet Unit) (Client FINS automatic node address allocation function, TCP/IP only)
		Handling TCP/IP	With FINS communications, both UDP/IP and TCP/IP possible.
		Simultaneous connection of multiple applications in a personal computer	Possible (with both UDP/IP and TCP/IP)
	Mail functions	E-mail attachments with I/O memory data are possible for the mail send function. (SMTP client function, file attachment function) With the mail receive function, commands can be received from the PLC. (POP3 client function, mail receive function)	Not Possible
FTP server function	Large files in file memory can be accessed (uploaded or downloaded) using FTP commands from FTP client software.	Not Possible	
Socket services function	Possible	Not Possible	
Automatic clock information adjustment	CPU Unit built-in clock can be adjusted from SNTP server. (SNTP client function)	Not Possible	

SECTION 2

Installation and Initial Setup

This section explains how to install the Ethernet Unit and make the initial settings required for operation.

2-1	Overview of Startup Procedure	22
2-1-1	Duplex Ethernet Networks	22
2-1-2	Non-duplex Ethernet Networks	24
2-2	Main Points in Creating a Duplex Ethernet Network	25
2-3	Switch Settings	26
2-3-1	CS-series CS1D Ethernet Units	26
2-4	Mounting to a PLC	29
2-4-1	Mounting to a CS1D Duplex-CPU System	29
2-4-2	Mounting to a CS1D Single-CPU System	29
2-5	Network Installation	30
2-5-1	Basic Installation Precautions	30
2-5-2	Recommended Products	31
2-5-3	Precautions	32
2-5-4	Using Contact Outputs (Common to All Units)	33
2-6	Connecting to the Network	34
2-6-1	Ethernet Connectors	34
2-6-2	Connecting the Cable	35
2-7	Creating I/O Tables	36
2-7-1	I/O Table Overview	36
2-7-2	Connecting Programming Devices to the PLC	36
2-7-3	Procedure for Creating I/O Tables	36
2-8	Enabling Duplex Communications	37
2-9	Unit Setup Procedure	39
2-10	Basic Settings	41
2-11	Communications Test	45
2-11-1	Using Indicators	45
2-11-2	PING Command	46
2-12	Replacing an Ethernet Unit	47

2-1 Overview of Startup Procedure

2-1-1 Duplex Ethernet Networks

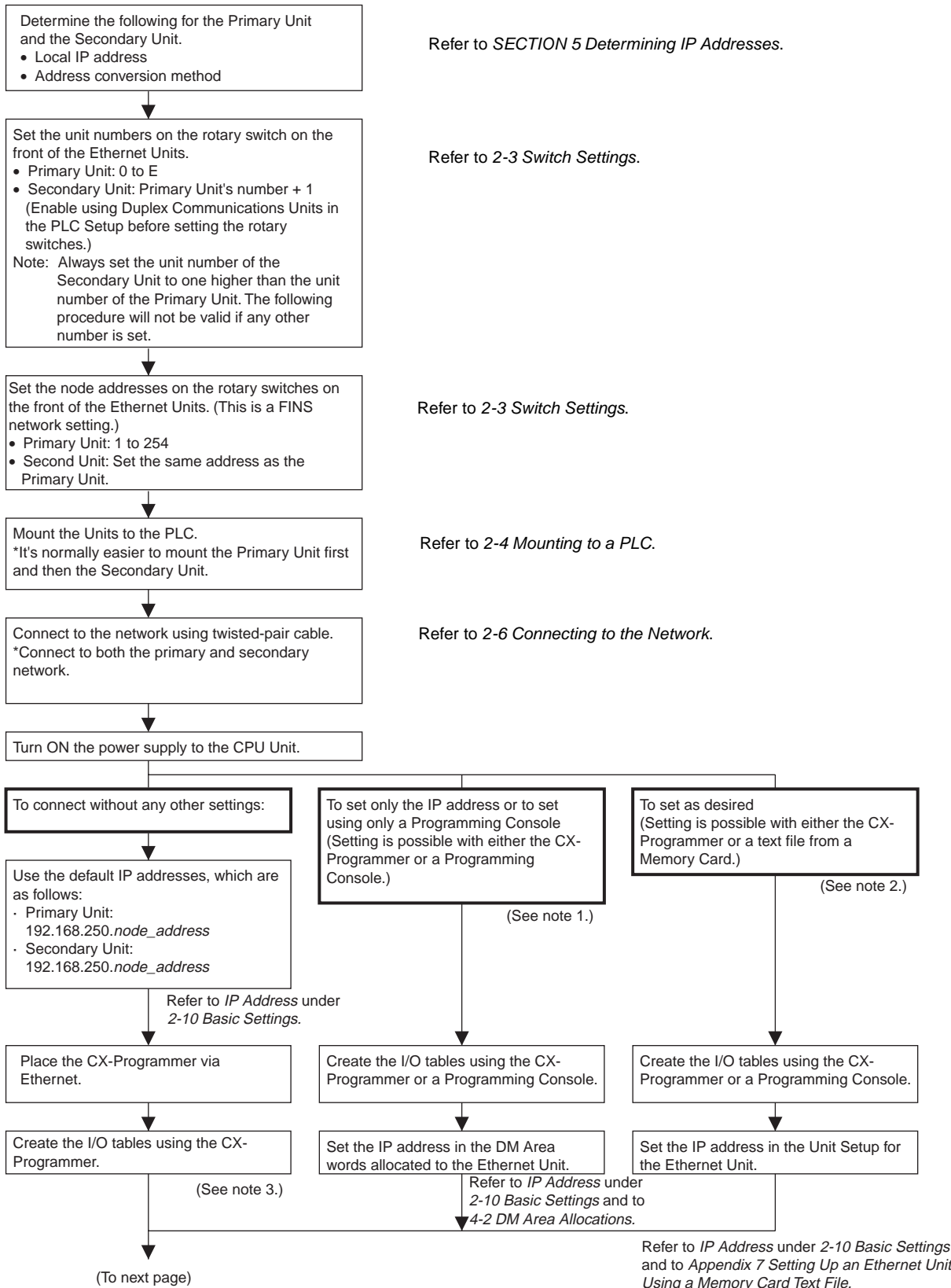

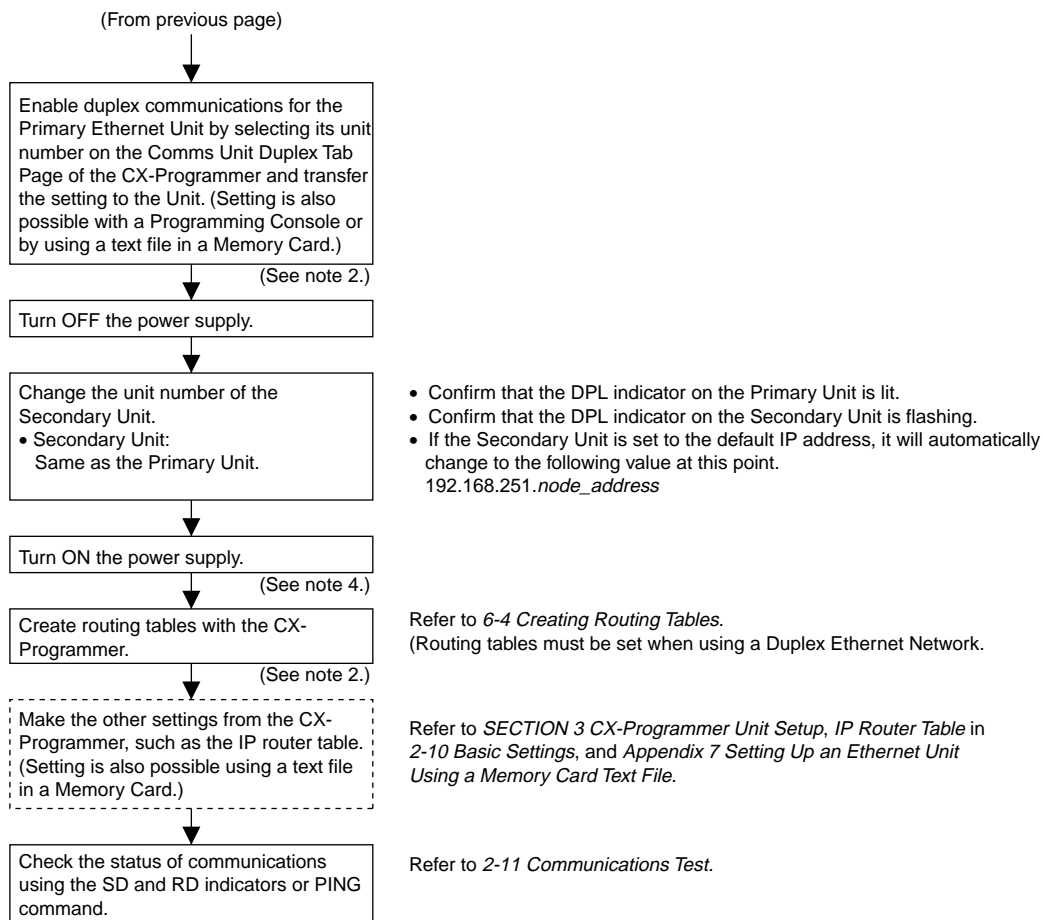

- Note**
- (1) Used mainly when setting the IP address using only a Programming Console (i.e., setting it in the words allocated in the DM Area). When using this method, the IP address in the Unit Setup must be at the default value of 00.00.00.00. If any other value is set in the Unit Setup it will be given priority over the setting in the DM Area and the setting in the DM Area will be changed.
 - (2) Setting is possible with CX-Programmer version 4.0 or higher or a Memory Card text file. A Memory Card text file is normally used when CX-Programmer version 4.0 or higher is not available. Refer to *Appendix G Using a Memory Card Text File to Set Up an Ethernet Unit* for details.
 - (3) A PLC Programming Device, such as the CX-Programmer, the CX-Net, or a Programming Console, is required.
 - (4) The CX-Net is required.

2-1-2 Non-duplex Ethernet Networks

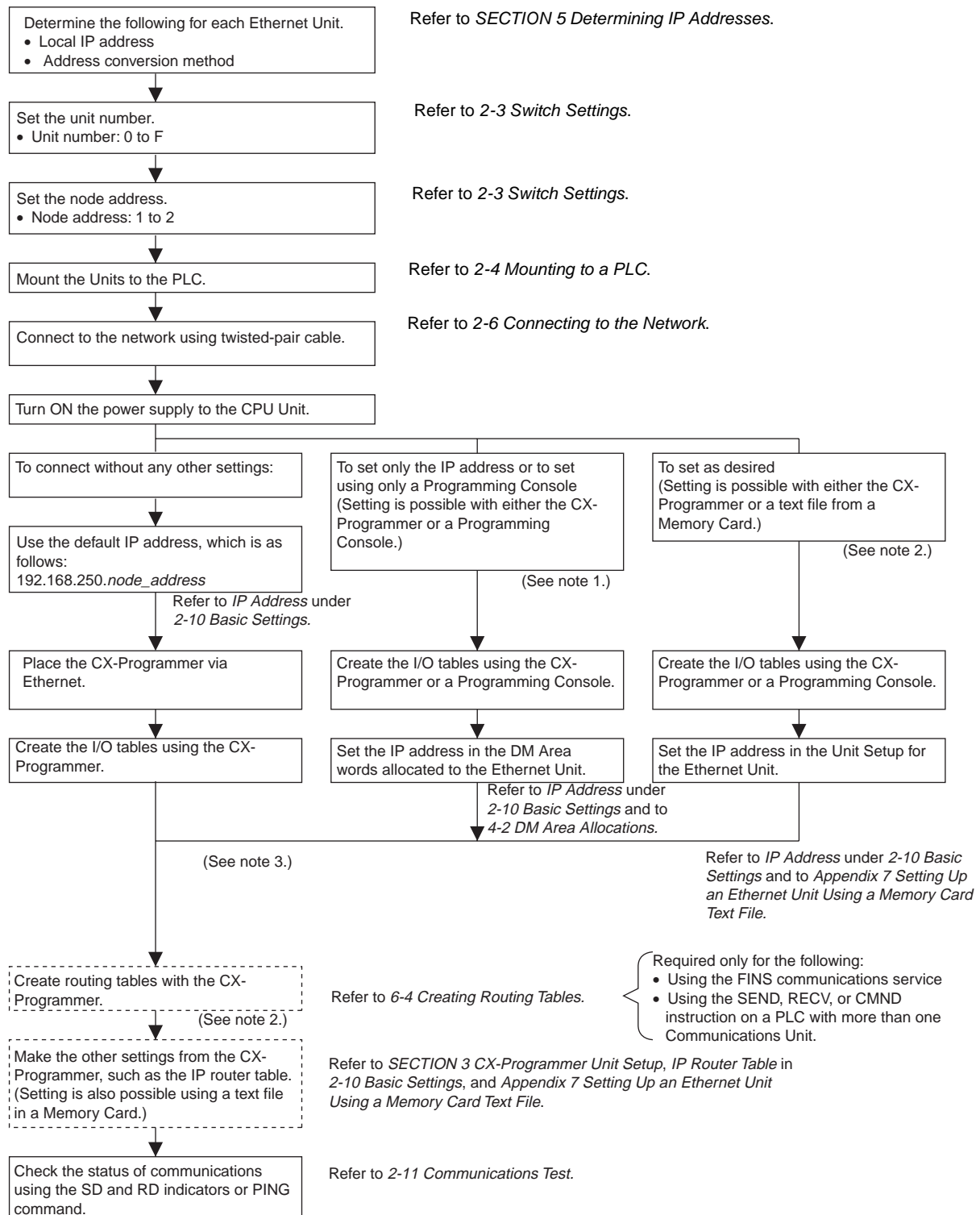

Note (1) Used mainly when setting the IP address using only a Programming Console (i.e., setting it in the words allocated in the DM Area). When using this method, the IP address in the Unit Setup must be at the default value of 00.00.00.00. If any other value is set in the Unit Setup it will be given priority over the setting in the DM Area and the setting in the DM Area will be changed.

- (2) Setting is possible with CX-Programmer version 4.0 or higher or a Memory Card text file. A Memory Card text file is normally used when CX-Programmer version 4.0 or higher is not available. Refer to *Appendix G Using a Memory Card Text File to Set Up an Ethernet Unit* for details.
- (3) A PLC Programming Device, such as the CX-Programmer, the CX-Net, or a Programming Console, is required.
- (4) The CX-Net is required.

2-2 Main Points in Creating a Duplex Ethernet Network

POINT 1: Initially set the unit number of the Secondary Unit to one higher than that of the Primary Unit

Before creating the I/O tables, set the unit number of the Secondary Unit to one higher than that of the Primary Unit and maintain this setting until duplex communications have been enabled in the PLC Setup. After enabling duplex communications in the PLC Setup, set the Primary Unit and Secondary Unit to the same unit number.

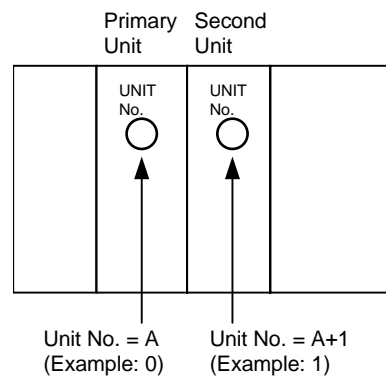

Note The unit number that was set for the Secondary Unit before enabling duplex communications cannot be used after duplex communications have been enabled in the PLC Setup. For example, if the Primary Unit is initially set to unit number 1 and the Secondary Unit is initially set to unit number 2, unit number 2 cannot be used for the Secondary Unit after enabling duplex communications.

POINT 2: Set the same node address for both the Primary Unit and Secondary Unit

The same node address is set for the Primary Unit and Secondary Unit from the beginning and does not need to be changed.

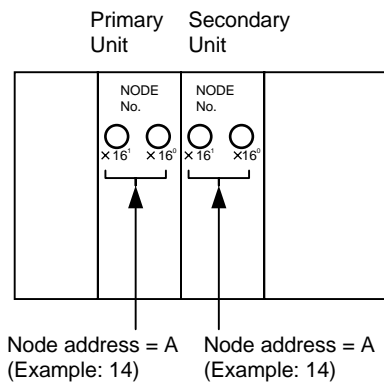

POINT 3: Enable Duplex Communications in the PLC Setup

After creating the I/O tables, enable duplex communications by selecting the unit number of the Primary Ethernet Unit on the Comms Unit Duplex Tab Page of the CX-Programmer (CS1D Communications Unit)

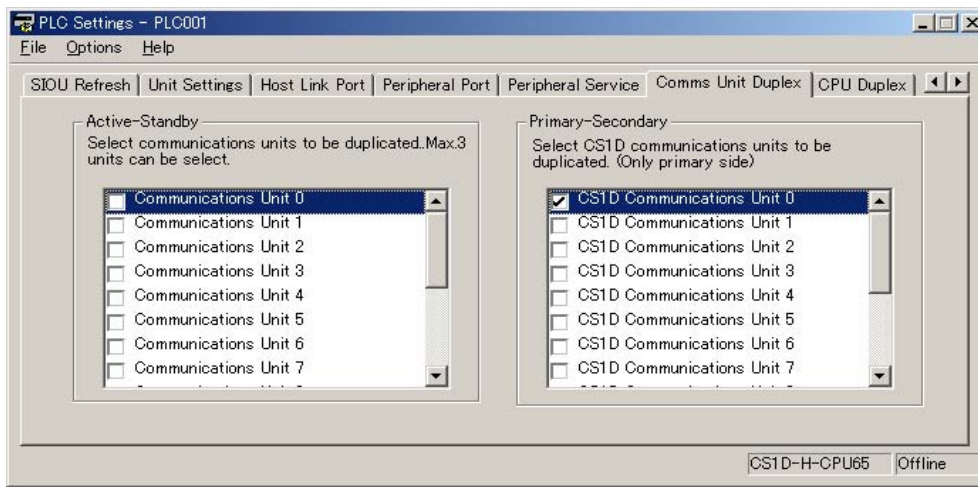

After making the above setting, transfer the settings to the Unit.

POINT 4: After enabling duplex communications, change the unit number of the Secondary Unit to the unit number set for the Primary Unit

After enabling duplex communications, change the unit number of the Secondary Unit to the same unit number as the one set for the Primary Unit

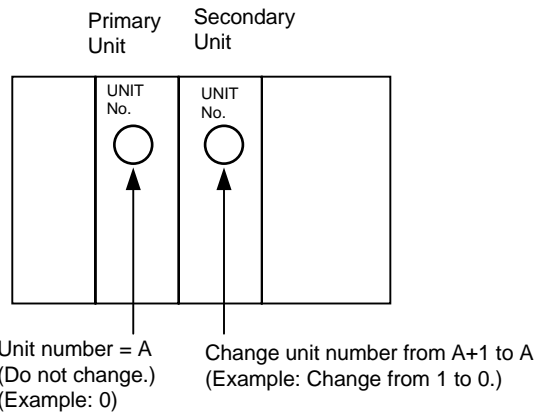

- Note**
- (1) Always use the procedure given in 2-3 Switch Settings to set the unit number. Duplex operation will not be possible for the Ethernet Units if this procedure is not used.
 - (2) Always create the I/O tables before enabling duplex communications in the PLC Setup. Duplex operation will not be possible if duplex communications are enabled before creating the I/O tables.

POINT 5: If the unit number of the Primary Unit or Secondary Unit is changed, redo the duplex setup procedure

If the unit number of the Primary Unit or Secondary Unit is changed, redo the duplex setup procedure from the point where the unit number of the Secondary Unit is set one higher than that of the Primary Unit.

2-3 Switch Settings

2-3-1 CS-series CS1D Ethernet Units

Setting the Unit Number

When using Duplex Ethernet Units, always use the following procedure to set Unit switches.

- 1,2,3... 1. Before creating the I/O tables and before enabling duplex communications in the PLC Setup, set the unit number of the Secondary Unit to one higher than that of the Primary Unit.

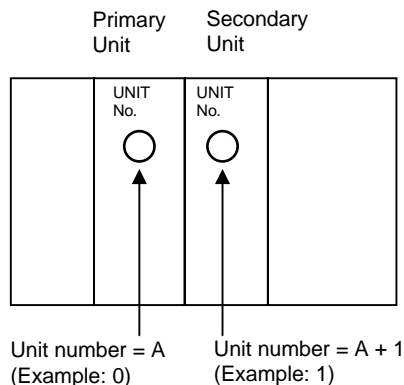

2. Create the I/O tables.
3. Enable duplex communications in the PLC Setup.
4. Set the unit number of the Secondary Unit to the same value as the Primary Unit. (Do not change the unit number of the Primary Unit.)

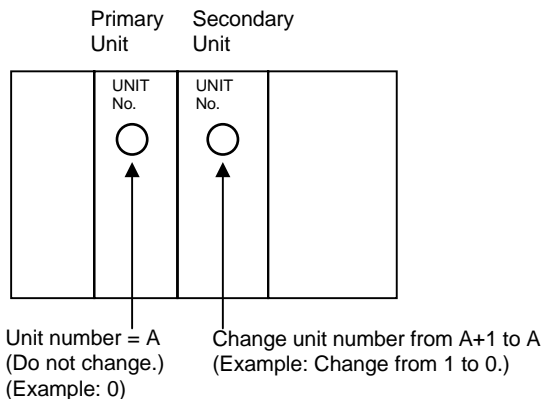

Do not set the same unit number for more than one CPU Bus Unit mounted in the same PLC. Use a small flat-blade screwdriver to make the setting, being careful not to damage the rotary switch. The factory setting is 0.

UNIT NO.	Setting range:	
	Duplex	0 to E
	Non-duplex	0 to F

- Note**
- (1) Turn OFF the power supply before setting the unit number.
 - (2) If the unit number is being set for the first time or changed, then I/O tables must be created for the PLC.
 - (3) Always use the above procedure to set the unit number. Duplex operation will not be possible for the Ethernet Units if this procedure is not used. The unit number of the Secondary Unit must be one higher than that of the Primary Unit before duplex communications are enabled and the unit numbers must be the same after duplex communications are enabled.
 - (4) To change the unit number, clear the I/O table and then repeat the unit number setting procedure from the beginning.

- (5) Enabled duplex communications in the PLC Setup after creating the I/O tables. Duplex operation will not be possible if duplex communications are enabled before creating the I/O tables.
- (6) With CS-series PLCs, words are automatically allocated in the CIO Area and DM Area according to the unit numbers that are set. For details, refer to *SECTION 4 Ethernet Unit Memory Allocations*.

Setting the Node Address

With the FINS communications service, when there are multiple Ethernet Units connected to the Ethernet network, the Ethernet Units are identified by node addresses. Use the node address switches (NODE NO.) to set the node address between 01 and FE hexadecimal (1 to 254 decimal). Do not set a number that has already been set for another node on the same network.

When using Duplex Ethernet Units, set the same node address for the Primary Unit and Secondary Unit. If a pair of Duplex Units are set to different node addresses and then duplex communications are enabled in the PLC Setup, a Duplex Verification error (non-fatal) will occur and the ERR/ALM indicator will flash. Refer to *2-8 Enabling Duplex Communications* for the procedure to enable duplex communications.

If the same node address is used for two different Ethernet Units on the same Ethernet line with Duplex Ethernet Units, the node that attempts to enter the network last will not function in the network participation status (which is vital to duplex network operation) and it will not participate in the network.

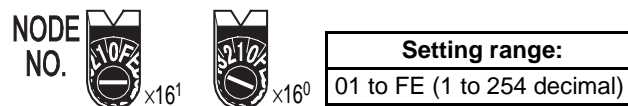

The left switch sets the sixteens digit (most significant digit) and the right switch sets the ones digit (least significant digit). The node address is factory-set to 01.

Note

- (1) Turn OFF the power supply before setting the node address.
- (2) Always set the same node address for the Secondary Unit and Primary Unit.

Relation to IP Addresses

When using the automatic generation method (either dynamic or passive) for address conversion, set the rightmost byte of the IP address set for the Ethernet Unit to the same value as the node address. If this is not possible, either the IP address table method or the combined method must be used for address conversion. (For details, refer to *5-2 IP Addresses in FINS Communications*.) If the FINS communications service is not used on the Ethernet network, then it is all right to overlap with other Ethernet Units. The setting, however, must be made within a range of 01 to FE. If a value outside of this range is set, the ERC indicator will light.

2-4 Mounting to a PLC

2-4-1 Mounting to a CS1D Duplex-CPU System

Ethernet Units can be mounted to any slots in either a CS1D Duplex-CPU System CPU Rack or an Expansion CPU Rack for Online Unit Replacement. Up to four CS1D Ethernet Units or four pairs of Duplex CS1D Ethernet Units can be mounted to a single PLC. If it is mounted in combination with other CPU Bus Units (e.g., Controller Link Units), the maximum total number of CPU Bus Units that can be mounted is 16.

Note Tighten PLC Backplane mounting screws to a torque of 0.9 N·m, and the Unit's screws to a torque of 0.4 N·m.

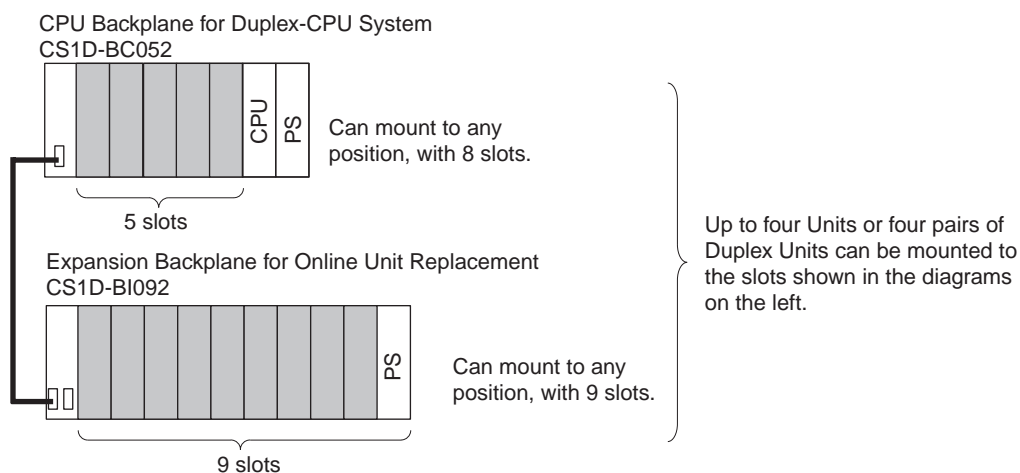

Note The CS1D-ETN21D CS1D Ethernet Unit's maximum current consumption is 380 mA. Make sure that the total current consumption of all the Units connected to the same CPU Backplane or Expansion Backplane does not exceed the output capacity of the Power Supply Unit.

2-4-2 Mounting to a CS1D Single-CPU System

Ethernet Units can be mounted to any slots in either a CS1D Single-CPU System CPU Rack or an Expansion CPU Rack for Online Unit Replacement. Up to four CS1D Ethernet Units or four pairs of Duplex CS1D Ethernet Units can be mounted to a single PLC. If it is mounted in combination with other CPU Bus Units (e.g., Controller Link Units), the maximum total number of CPU Bus Units that can be mounted is 16.

Note Tighten PLC Backplane mounting screws to a torque of 1.2 N·m, and the Unit's screws to a torque of 0.8 N·m.

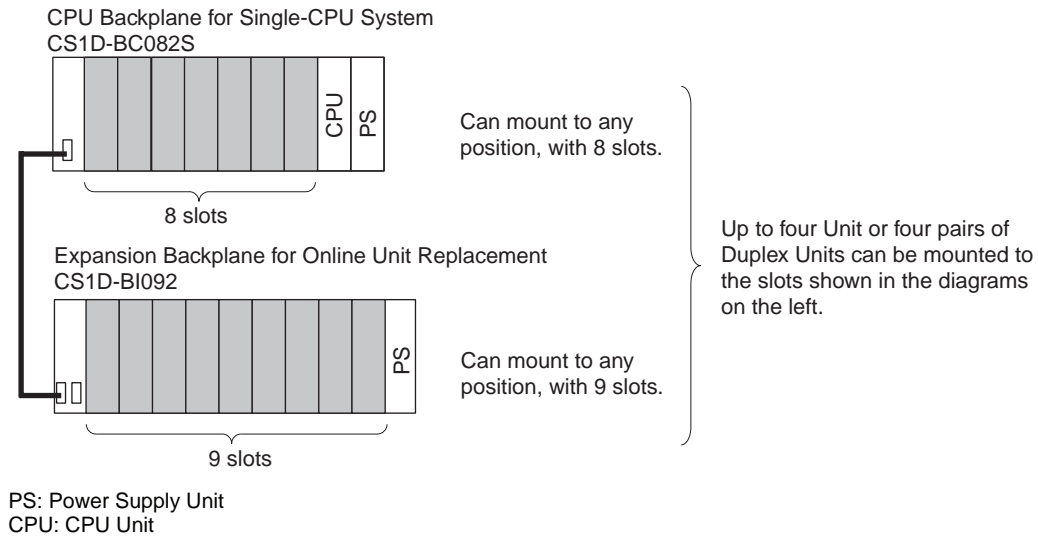

Note The CS1D-ETN21D CS1D Ethernet Unit's maximum current consumption is 380 mA. Make sure that the total current consumption of all the Units connected to the same CPU Backplane or Expansion Backplane does not exceed the output capacity of the Power Supply Unit.

2-5 Network Installation

2-5-1 Basic Installation Precautions

- Take the greatest care when installing the Ethernet System, being sure to follow ISO 8802-3 specifications. You must obtain a copy of these specifications and be sure you understand them before attempting to install an Ethernet System. Unless you are already experienced in installing communications systems, we strongly recommend that you employ a professional to install your system.
- Do not install Ethernet equipment near sources of noise. If noise-prone environments are unavoidable, be sure to take adequate measures against noise interference, such as installing network components in grounded metal cases, using optical links in the system, etc.

2-5-2 Recommended Products

The following products are recommended for use with the CS1D-ETN21D CS1D Ethernet Unit.

Part	Maker	Model number	Specifications	Inquires
Hub	100Base-TX			
	PHOENIX CONTACT	SWITCH 5TX	5-port hub Note Suitable for FA environments.	
	Allied Telesis	RH509E	CenterCOM FS705EL (5 port hub) Note Suitable for OA environments.	Allied Telesis (0120) 86-0442 (in Japan only)
	10Base-T			
	Allied Telesis	RH509E	9-port hub Note Suitable for OA environments.	Allied Telesis (0120) 86-0442 (in Japan only)
MR820TLX		9-port hub with 10Base-5 backbone port Note Suitable for OA environments.		
Twisted-pair cable	100Base-TX			
	Fujikura	F-LINK-E 0.5mm x 4P	STP (shielded twisted-pair) cable: Category 5, 5e Note Impedance is limited to 100 Ω.	---
	Fujikura	CTP-LAN5 0.5mm x 4P	UTP (unshielded twisted-pair) cable: Category 5, 5e	
	10Base-T			
	Fujikura	F-LINK-E 0.5mm x 4P	STP (shielded twisted-pair) cable: Category 3, 4, 5, 5e Note Impedance is limited to 100 Ω.	
	Fujikura	CTP-LAN5 0.5mm x 4P	UTP (unshielded twisted-pair) cable: Category 3, 4, 5, 5e	
Connectors (Modular plug)	STP Plug			
	Panduit Corp	MPS588	---	
	UTP Plug			
Panduit Corp	MP588-C	---		

2-5-3 Precautions

Precautions on Laying Twisted-pair Cable

Basic Precautions

- Press the cable connector in firmly until it locks into place at both the hub and the Ethernet Unit.
- After laying the twisted-pair cable, check the connection with a 10Base-T cable tester.

Environment Precautions

- The UTP cable is not shielded, and the hub is designed for use in OA environments. In environments subject to noise, construct a system with shielded twisted-pair (STP) cable and hubs suitable for an FA environment.
- Do not lay the twisted-pair cable together with high-voltage lines.
- Do not lay the twisted-pair cable near devices that generate noise.
- Do not lay the twisted-pair cable in locations subject to high temperatures or high humidity.
- Do not lay the twisted-pair cable in locations subject to excessive dirt and dust or to oil mist or other contaminants.

Hub Installation Environment Precautions

- Do not install the hub near devices that generate noise.
- Do not install the hub in locations subject to high temperatures or high humidity.
- Do not install the hub in locations subject to excessive dirt and dust or to oil mist or other contaminants.

Hub Connection Methods

If more hub ports are required, they can be added by connecting more than one hub. There are two possible connection methods for hubs: Cascade and stacked.

Cascade Connections

- Connect two hubs to each other as follows: Connect an MDI port to an MDI-X port with a straight cable; connect two MDI ports with a cross cable; and connect two MDI-X ports with a cross cable.

Note It is very difficult to distinguish cross cables and straight cables by appearance. Incorrect cables will cause communications to fail. We recommend using cascade connections with straight cables whenever possible.

- With cascade connections, up to 5 segments can be connected using up to 4 repeaters (i.e., 4 hubs).

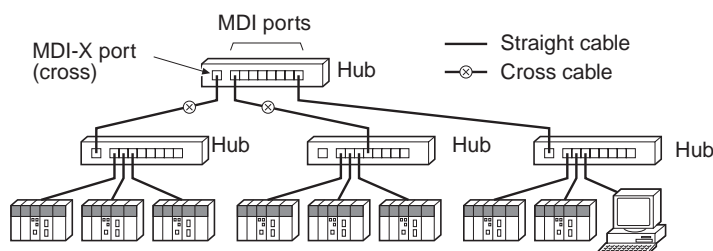

Stack Connections

- Connect the hubs using special cables or special racks.
- Normally there is no limit to the number of hubs in a stack, and each stack is treated as one hub. Some hubs, however, are limited in the number of hubs per stack.

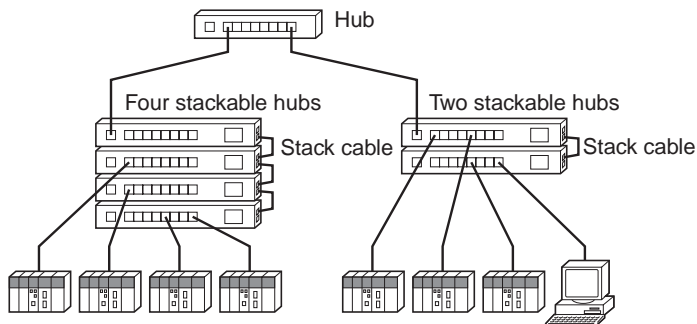

2-5-4 Using Contact Outputs (Common to All Units)

Communications errors can occur when Contact Output Units are mounted to the same Rack or connected to the same PLC as an Ethernet Unit due to noise generated by the contact outputs. Use one or more of the following measures when installing Contact Output Units and Ethernet Units on the same Rack.

Mounting Location

Mount (or connect) any Contact Output Units as far away from the CS1D Ethernet Unit as possible.

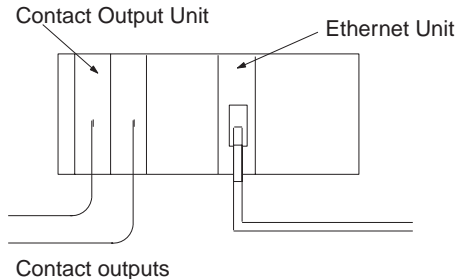

Cable Location

Separate the transceiver cable or twisted-pair cable connecting the CS1D Ethernet Unit as far from the wiring to the Contact Output Units as possible. The coaxial cable must also be placed as far away from the Contact Output Units and their wiring as possible.

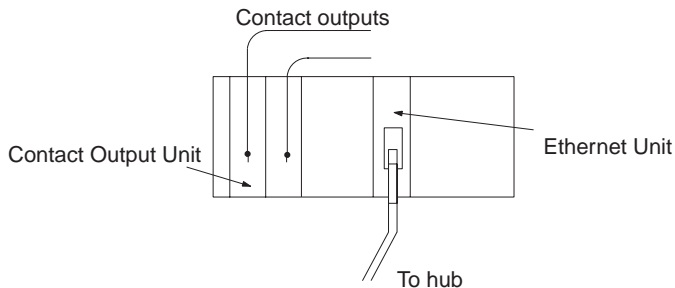

Hub Measures

Attach several ferrite cores designed for EMI countermeasures on the transceiver cable or twisted-pair cable near the hub. The transceiver must also be placed as far away from the Contact Output Units and their wiring as possible.

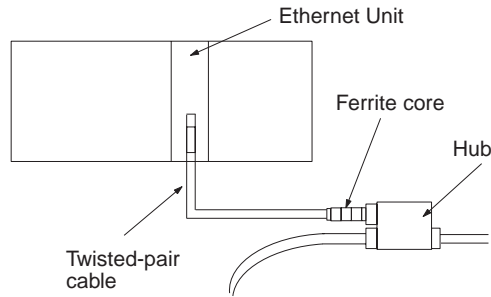

2-6 Connecting to the Network

2-6-1 Ethernet Connectors

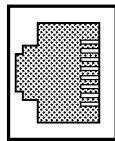

The following standards and specifications apply to the connectors for the Ethernet twisted-pair cable.

- Electrical specifications: Conforming to IEEE802.3 standards.
- Connector structure: RJ45 8-pin Modular Connector (conforming to ISO 8877)

Connector pin	Signal name	Abbr.	Signal direction
1	Transmission data +	TD+	Output
2	Transmission data –	TD–	Output
3	Reception data +	RD+	Input
4	Not used.	---	---
5	Not used.	---	---
6	Reception data –	RD–	Input
7	Not used.	---	---
8	Not used.	---	---
Hood	Frame ground	FG	---

2-6-2 Connecting the Cable

- ⚠ **Caution** Turn OFF the PLC's power supply before connecting or disconnecting twisted-pair cable.
- ⚠ **Caution** Allow enough space for the bending radius of the twisted-pair cable as shown in below.

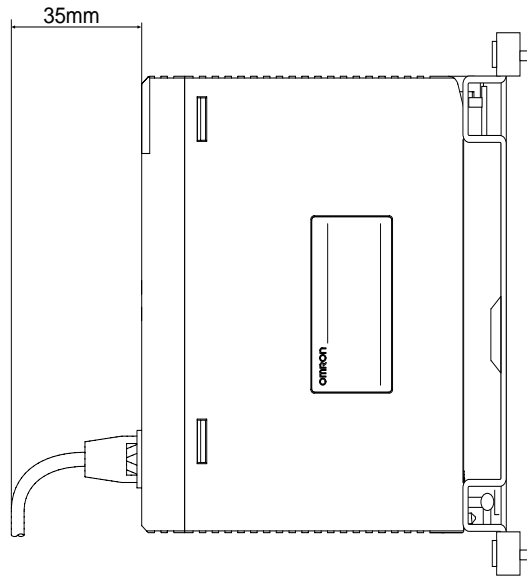

- 1,2,3...**
1. Lay the twisted-pair cable.
 2. Connect the cable to the hub. Be sure to press in the cable until it locks into place. A simple installation example for these first two steps is provided in an appendix at the end of this manual.
Request cable installation from a qualified professional.
 3. Connect the cable to the connector on the CS1D Ethernet Unit. Be sure to press in the cable until it locks into place.

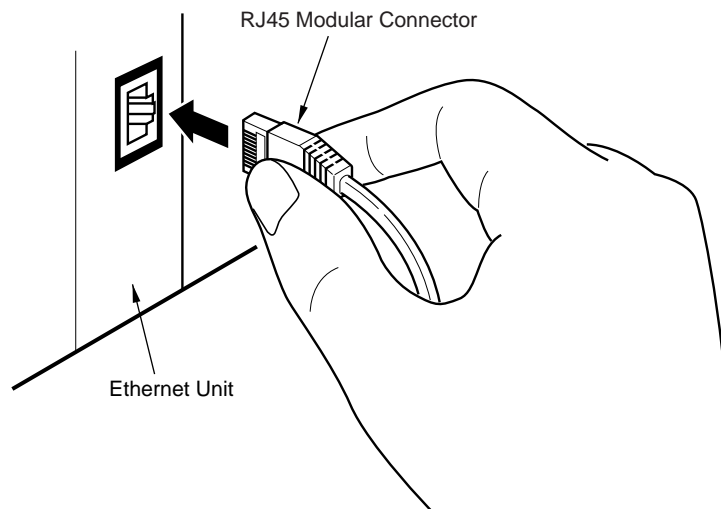

2-7 Creating I/O Tables

2-7-1 I/O Table Overview

I/O tables are used to identify Units mounted to the PLC, and to allocate I/O to them. With CS-series CS1D PLCs, whenever there is a change to the Unit configuration it is necessary to create I/O tables and register the Units to the CPU Unit.

The I/O tables can be created in the following ways.

- Using the CX-Programmer offline.
- Using the CX-Programmer online, with the Units mounted to the PLC.
- Using the Programming Console, with the Units mounted to the PLC.

- Note**
- (1) Before creating the I/O tables, always set the unit number of the Secondary Unit to one higher than that of the Primary Unit.
 - (2) Always use the procedure given in 2-3 *Switch Settings* to set the unit number. Duplex operation will not be possible for the Ethernet Units if this procedure is not used.
 - (3) Always create the I/O tables before enabling duplex communications in the PLC Setup. Duplex operation will not be possible if duplex communications are enabled before creating the I/O tables.

2-7-2 Connecting Programming Devices to the PLC

To create the I/O tables, connect a Programming Device (such as a CX-Programmer or Programming Console) to the PLC.

Applicable Programming Devices

The following Programming Devices can be used with CS-series CS1D PLCs.

Programming Console

Model number	Key Sheet (required)	Recommended cable (required)
C200H-PRO27-E	CS1W-KS001-E	CS1W-CN224 (cable length: 2.0 m) CS1W-CN624 (cable length: 6.0 m)
CQM1-PRO01-E		CS1W-CN114 (cable length: 0.1 m)
CQM1H-PRO01-E		

CX-Programmer and CX-Net (Version 4.0 or higher)

Model number: WS02-CXPC1-EV4

The operations are explained here using a Programming Console. For details regarding the CX-Programmer and the CX-Net, refer to the *CX-Programmer User's Manual*.

CX-Net is software that comes with CX-Programmer and is automatically installed when CX-Programmer is installed.

Connecting Programming Devices

To connect a Programming Console, attach a CS/CJ-series Key Sheet and then connect the Console to the CPU Unit's peripheral port. (It cannot be connected to the RS-232C port.)

2-7-3 Procedure for Creating I/O Tables

The procedure for creating I/O tables is shown here, taking as an example I/O tables that is generated automatically for a PLC connected online. In this example, a Programming Console is used for creating the I/O tables. For an explanation of how to create I/O tables using a CX-Programmer, refer to the *CX-Programmer User's Manual*.

Use the following procedure to create the I/O tables.

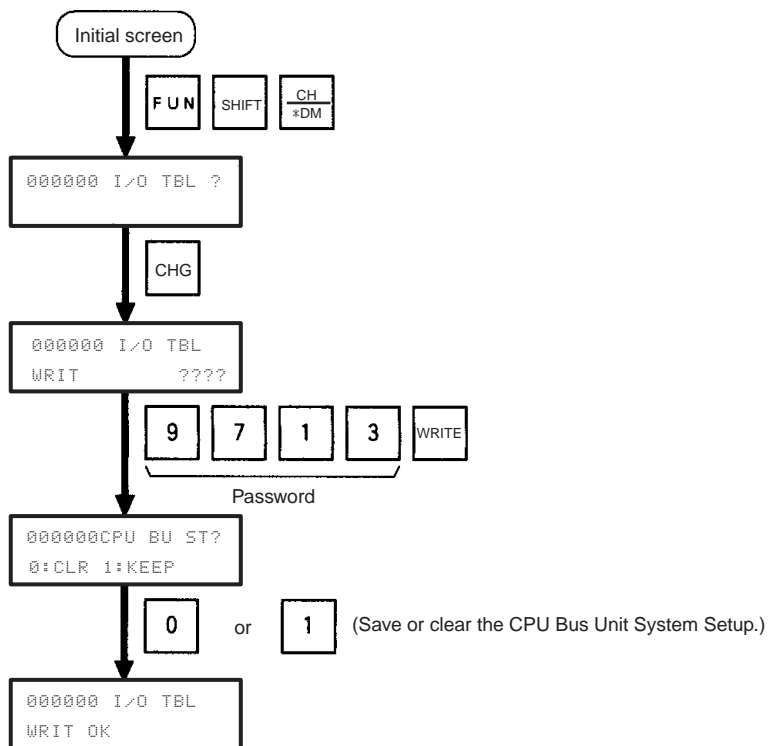

2-8 Enabling Duplex Communications

To use Duplex Ethernet Units, duplex communications must be enable in the PLC Setup for the Ethernet Units registered in the I/O tables. The PLC Setup can be set with CX-Programmer version 4.0 or higher. The CX-Programmer procedure for enabling duplex communications is given below.

Note Before creating the I/O tables, always set the unit number of the Secondary Unit to one higher than that of the Primary Unit.

- 1,2,3... 1. Place the CX-Programmer online with the PLC. Use one of the following methods to connect the CX-Programmer to the PLC.
 - Used a serial cable to connect the computer running CX-Programmer to the peripheral port or RS-232C port on the CPU Unit.
 - Connect the computer and PLC Unit Ethernet.
 When Ethernet Unit information is registered in the PLC's I/O tables, the Ethernet Units will operate using the default IP addresses:
 Primary Unit: 192.168.250.*node_address*
 Secondary Unit: 192.168.251.*node_address*
 These default addresses can be used to connect via Ethernet.

Refer to the manual for the CX-Programmer for instructions on connecting with a serial cable. Refer to 6-5 Using FINS Applications for instructions on connecting the CX-Programmer to the PLC via the Ethernet Unit.
2. Double-click the **Settings** Icon from the Project Window (or use the pop-up menu to open the settings).

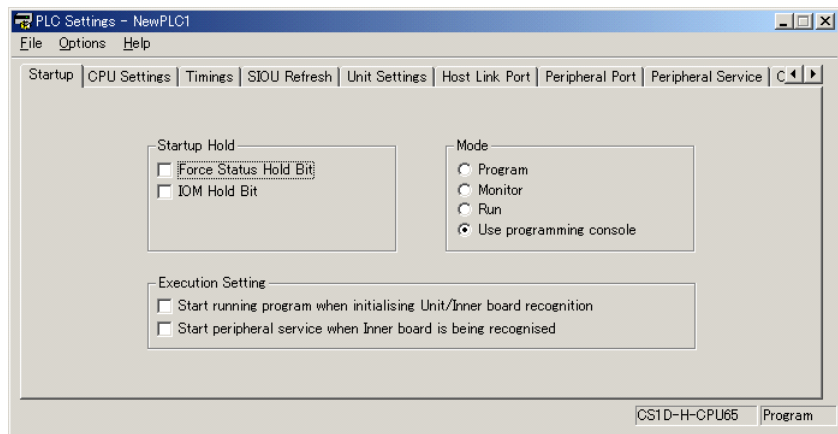

3. Click the Comms Unit Duplex Tab and select the CS1D Communications Unit with the unit number of the Primary Ethernet Unit.

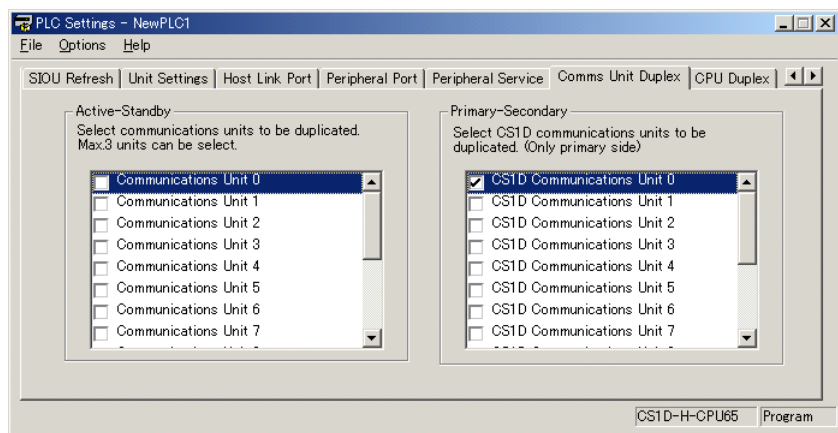

4. Transfer the PLC Setup to the PLC. Click the **Yes** Button in the following dialog box.

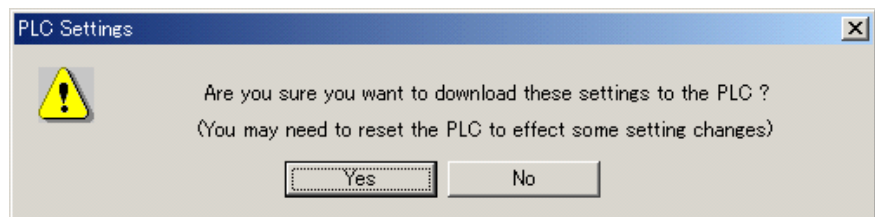

5. Turn OFF the power supply to the PLC.
6. Set the unit number of the Secondary Unit to the same number as that of the Primary Unit.
7. Turn ON the power to the PLC.

Note

- (1) Before creating the I/O tables, always set the unit number of the Secondary Unit to one higher than that of the Primary Unit.
- (2) Always use the procedure given in 2-3 *Switch Settings* to set the unit number. Duplex operation will not be possible for the Ethernet Units if this procedure is not used.
- (3) Always create the I/O tables before enabling duplex communications in the PLC Setup. Duplex operation will not be possible if duplex communications are enabled before creating the I/O tables.

2-9 Unit Setup Procedure

Use the CX-Programmer (Ver. 4.0 or higher) for the CS1D Ethernet Unit Setup, and follow the procedure described below.

1,2,3...

1. Connect the CX-Programmer online.

The CX-Programmer can be connected to the PLC in either of the following ways:

- a. Connect the personal computer to the PLC by serial cable, through either a peripheral port or RS-232C port.
- b. Connect the personal computer to the PLC by Ethernet.

When Ethernet Unit is registered in the I/O tables in the CPU Unit, the Ethernet Unit will operate using the default IP address (Primary Unit: 192.168.250.*node_number*, Secondary Unit: 192.168.251.*node_number*). This default IP address can be used initially to connect online.

For details on connecting the CX-Programmer to the PLC by serial cable, refer to the CX-Programmer operation manual.

For details on connecting the CX-Programmer to the PLC by Ethernet, refer to 6-5 Using FINS Applications.

2. Use the mouse to select *I/O table* in the Project Window. Either double-click or right-click to display the Properties Menu, and select *Open*. The I/O Table Window will then be displayed.

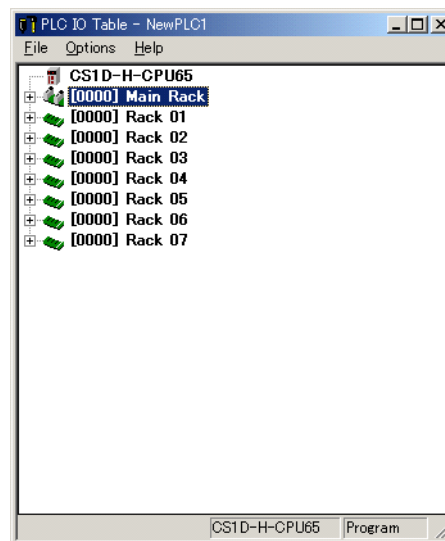

3. Read the I/O tables from the PLC and select the Rack to which the CS1D Ethernet Unit is mounted.

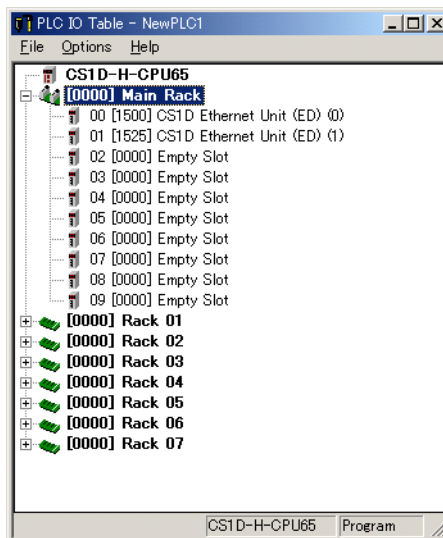

4. Move the cursor to the Ethernet Unit and right-click. Select *Unit Setup* from the popup menu to display the window for making the Ethernet Unit Setup. The default settings are shown below.

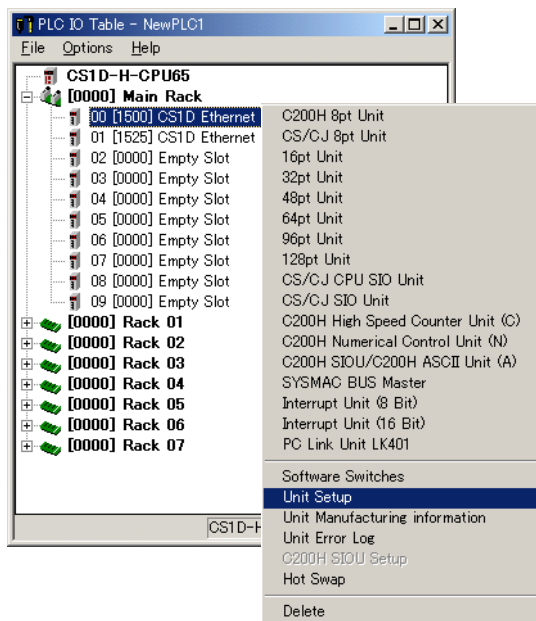

At the point where the Ethernet Unit is mounted and the I/O tables has just been created, the default values are in effect for all of the settings.

- 5. Make the required settings (i.e., the IP address in this case).

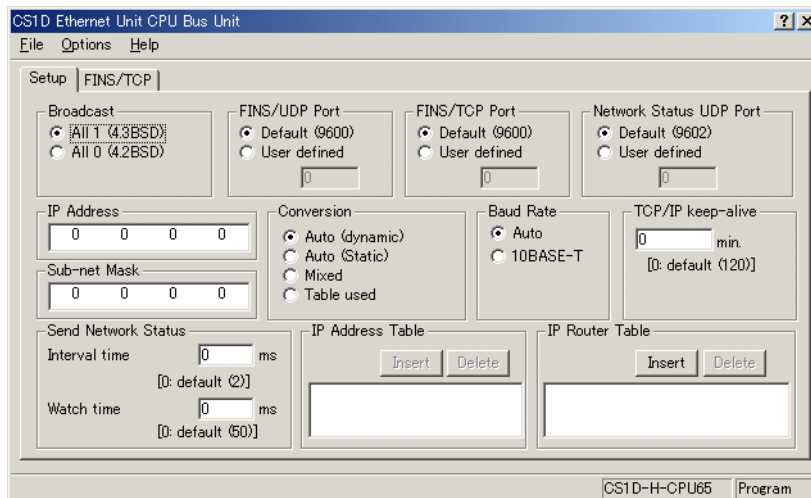

- 6. Transfer the settings to the PLC.
Click on **Yes** in the following dialog box.

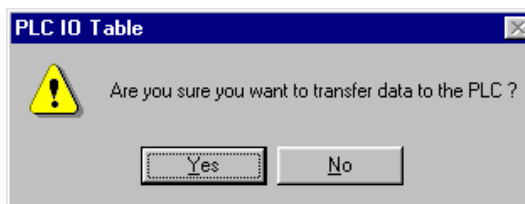

- 7. In order for the Ethernet Unit Setup to go into effect, the Unit must be re-started.
Click on **Yes** in the following dialog box.

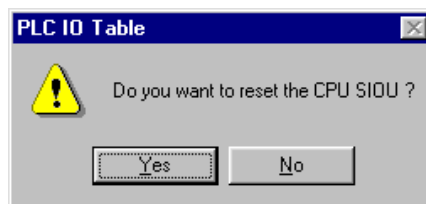

- 8. Check the Ethernet Unit's LED indicators.
After the RUN indicator has turned OFF and then turned ON again, the Ethernet will recognize the new settings (i.e., the IP address in this case).

2-10 Basic Settings

The following items comprise the basic settings in the Ethernet Unit (100Base-TX) setup. Each item is described in detail below.

- IP address
- Subnet mask
- Broadcast settings
- Baud rate
- TCP/IP keep-alive
- IP router table

■ **IP Address**

For the IP address, set the Ethernet Unit's local IP address.

Depending on the value that is set, the IP address has a great influence on the connectability of the Ethernet Unit. To make full use of the Ethernet functions, it is necessary to study the applications and network system design when determining IP address allocations. Before setting the IP address, refer to *SECTION 5 Determining IP Addresses*.

There are several ways to set IP addresses.

Default Setting

The Ethernet Unit operates using the default IP address when the Unit is mounted to the PLC and initially registered in the I/O tables (i.e., when the Unit settings have not been made and the IP Address Display/Setting in the CPU Bus Unit Words Allocated in the DM Area is still all zeros).

The default IP address is determined as follows:

Duplex Ethernet Networks:

Default IP address = 192.168.250.FINS node address

Default IP address = 192.168.251.FINS node address

Non-Duplex Ethernet Networks:

Default IP address = 192.168.250.FINS node address

The FINS node address is set by the rotary switch on the front of the Ethernet Unit. If the defaults are used for the IP address and the Unit settings, the settings will be as shown below.

Item	Operation status
IP address	192.168.250.FINS node address
Subnet mask	255.255.255.0 (Class C mask)
Broadcast settings	4.3BSD
Baud rate	Auto
TCP/IP keep-alive	120 min.
IP router table	None (IP router not enabled)

Setting the IP Address in the CPU Bus Unit Words Allocated in the DM Area

This method sets the IP address in the IP Address Display/Setting Area in the CPU Bus Unit Words Allocated in the DM Area, when the IP address is not set in the Unit Setup. When the IP address is set in the Unit Setup, the IP Address Display/Setting Area becomes the area for displaying the settings.

To make settings in the IP Address Display/Setting Area, use the CX-Programmer or Programming Console to write the values. In order for the new settings to go into effect, either the Ethernet Unit must be restarted or the power must be turned ON again to the PLC.

	15	14	13	12	11	10	9	8	7	6	5	4	3	2	1	0
m+98	(1)				(2)				(3)				(4)			
m+99	(5)				(6)				(7)				(8)			

IP address: (1)(2).(3)(4).(5)(6).(7)(8) (hexadecimal)

If only the IP address is set, according to the IP Address Display/Setting Area, and the defaults are used for all other Unit settings, the settings will be as shown below.

Item	Status
IP address	Words allocated for CPU Bus Unit (m+98 to m+99)
Subnet mask	Uses value corresponding to IP address class.
Broadcast settings	4.3BSD specifications
Baud rate	Auto
TCP/IP keep-alive	120 minutes
IP router table	Not set. (IP routing not supported.)

Unit Setup

This method sets the IP address by first selecting the Ethernet Unit from the CX-Programmer's I/O Table Window while connected online, and then setting the IP address from the Unit Setup.

Example: Using the CX-Programmer to Set the IP Address to 10.3.65.1

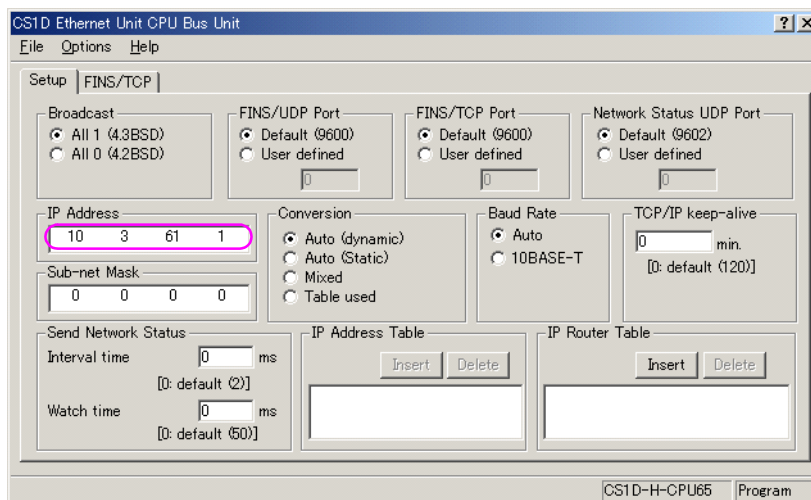

When an IP address is set in the Unit Setup, that value is displayed in the IP Address Display/Setting Area in the DM Area words allocated for CPU Bus Units.

When the IP address is set by the CX-Programmer, and the defaults are used for all other Unit settings, the settings will be as shown below.

Item	Status
IP address	Set by CX-Programmer.
Subnet mask	Uses value corresponding to IP address class.
Broadcast settings	4.3BSD specifications
Baud rate	Auto
TCP/IP keep-alive	120 minutes
IP router table	Not set. (IP routing not supported.)

■ **Subnet Mask**

For the subnet mask, all bits corresponding to the bits in the IP address used as either the net number or the subnet number are set to 1, and the bits corresponding to the host number are set to 0. These settings must be made when using an address conversion method other than the IP address table method.

If no subnet mask is set, or if an illegal value is set, the following values will be used depending on the IP address class.

Class	Subnet mask
Class A	255.0.0.0
Class B	255.255.0.0
Class C	255.255.255.0

With the default setting (0.0.0.0), a subnet mask corresponding to the IP address class is used.

■ **Broadcast Settings**

Set the method for specifying IP addresses when broadcasting.

Setting	Contents
All 1 (4.3BSD) (Default)	Broadcast with all ones for Host ID (4.3BSD specifications).
All 0 (4.2BSD)	Broadcast with Host ID all zeros (4.2BSD specifications).

■ **Baud Rate**

Set the baud rate.

Setting	Contents
Auto (Default)	Automatically detects the baud rate between hubs. Operates with 100Base-TX (full duplex) whenever possible.
10Base-T	Operates with 10Base-T (half duplex).

■ **TCP/IP Keep-alive Setting**

Set the Liveness-Checking Interval. (This setting is enabled only when FINS/TCP or TCP/IP socket services are used.)

When the keep-alive function is used with FINS/TCP or TCP/IP socket services, the keep-alive communications frame is used to check the status of the connection with the remote node (either a server or client) if there are no communications during the time interval set here. Up to nine checks are executed at 75-second intervals, and if there is no response to any of them then the connection is terminated.

The original setting may not be appropriate for all control system applications. When the prescribed value is used as is, it may not be suitable for control system applications. Set the checking time as required for the system. The setting range is 0 to 65,535 minutes.

■ **IP Router Table**

An IP router table is a table of correspondences for finding IP addresses for the IP routers that relay target segments when the Unit communicates via IP routers with nodes on other IP network segments.

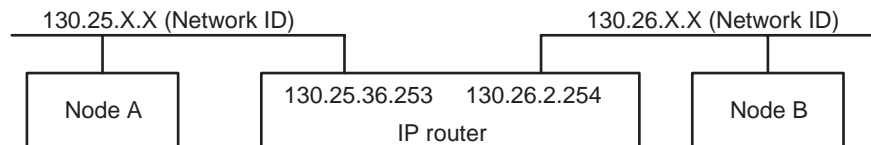

For the IP network address, set the network number (i.e., the net ID) of the other IP network segment with which communications are to be executed. The length of the network number (i.e., the number of bytes) will vary depending on the IP address class. Four bytes are reserved for setting the IP network address, so set the network number from the beginning and then set 00 in the remaining space.

A maximum of eight settings can be registered. The default is for nothing to be set.

Settings

In this example setting for Node A (refer to the diagram above), a network with a Network ID of 130.26.XX is connected to an IP router with an IP address of 130.25.36.253.

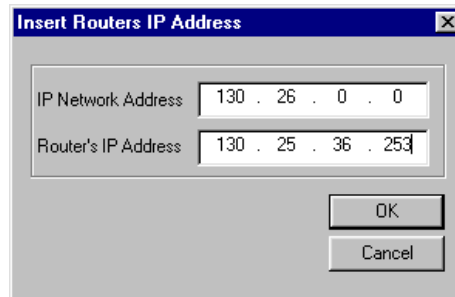

Only one default IP router can be set.

The default IP router is selected when no Network ID exists in the IP router table for the destination network number. To set the default IP router, set 0.0.0.0 for the IP address and set the default IP router's IP address for the router address.

2-11 Communications Test

2-11-1 Using Indicators

LNK Indicator

The LNK indicator will light when communications are possible between the Ethernet Unit and hub. This indicator can thus be used to determine if there are any faults or faulty connections in the Units, cables, and hub.

100M Indicator

Once the LNK indicator is lit, the 100M indicator can be used to determine the baud rate. The default setting of the baud rate of the Ethernet Unit is set to automatically detect the network baud rate. If 100Base-TX is detected, the 100M indicator will light. If 10Base-T is detected, the 100M indicator will not light. The Ethernet Unit can be set either to detect the baud rate or to use 10Base-T.

DPL Indicator

The DPL indicator will light when the Ethernet Unit is set for duplex communications. Use it to confirm this duplex settings.

DPL Indicator: Lit

The Ethernet Unit is set as the Primary Unit for duplex operation.

DPL Indicator: Not Lit

The Ethernet Unit is set as the Secondary Unit for duplex operation.

DPL Indicator: Flashing

The Ethernet Unit is set for non-duplex operation.

SD and RD Indicators

If Ethernet Units are being used for a duplex network, network status will be broadcast periodically. The SD and RD indicators will flash when network status is broadcast.

SD and RD Indicators: Flashing

The Ethernet Unit is participating normally in the network.

SD Indicator: Flashing, RD Indicator: Not Lit

The Ethernet Unit is not participating normally in the network. Check for other Ethernet Units set for duplex operation in the same network and check the communications path (Units, cables, and hub).

SD and RD Indicators: Not Lit

The Ethernet Unit is not set for duplex operation. Refer to 2-1-1 *Duplex Ethernet Networks* and set up duplex operation.

2-11-2 PING Command

If the basic settings (in particular the IP address and subnet mask) have been made correctly for the Ethernet Unit, then it should be possible to communicate with nodes on the Ethernet.

This section describes how to use the PING command to perform communications testing between Ethernet Units.

PING Command Overview

The PING command sends an echo request packet to a remote node and receives an echo response packet to confirm that the remote node is communicating correctly. The PING command uses the ICMP echo request and responses. The echo response packet is automatically returned by the ICMP.

The PING command is normally used to check the connections of remote nodes when configuring a network. The Ethernet Unit supports both the ICMP echo request and reply functions.

If the remote node returns a normal response to the PING command, then the nodes are physically connected correctly and Ethernet node settings are correct.

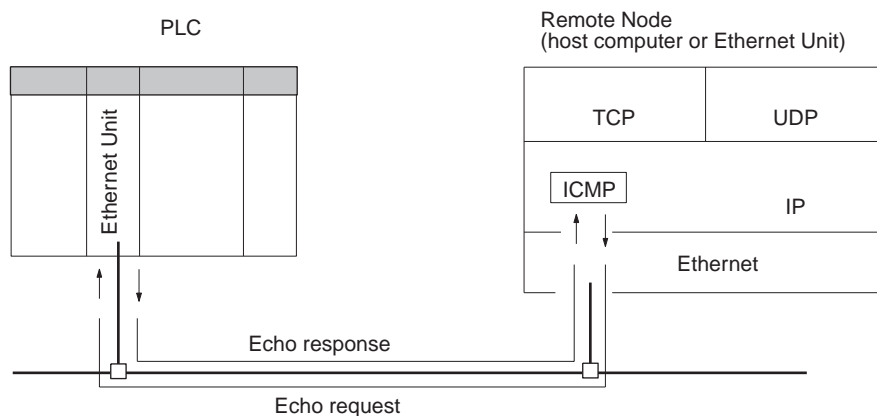

Using the PING Command from the Ethernet Unit

The Ethernet Unit automatically returns the echo response packet in response to an echo request packet sent by another node (host computer or other Ethernet Unit). An echo request packet can be sent to another node by issuing the FINS command to execute the PING command from the PLC. Refer to page 143 for details on the PING command.

Using the PING Command from the Host Computer

The PING command can be executed from the host computer to send an echo request packet to an Ethernet Unit. The method for using the PING command from a UNIX computer is given next.

■ **Method**

Input the following at the host computer prompt (\$):

```
$ ping IP_address(host_name)
```

The destination is specified by its IP address or host name. If the host name is used, the host name must be defined in file /etc/hosts.

Note The PING command is not supported by some host computers.

■ **Application Examples**

These examples show sending the PING command to the node at IP address 130.25.36.8. The "\$" in the example represents the host computer prompt. User inputs are underlined. Comments are placed after semicolons.

Normal Execution

```
$ ping 130.25.36.8 ; Executes PING command
PING 130.25.36.8: 56 data bytes
64 bytes from 130.25.36.8: icmp_seq=0. time=0.ms
64 bytes from 130.25.36.8: icmp_seq=0. time=0.ms
      .           .           .
      .           .           .
      .           .           .
64 bytes from 130.25.36.8: icmp_seq=0. time=0.ms
                                           ;Enter Ctrl+C Key to cancel.
----130.25.36.8 PING Statistics----
9 packets transmitted, 9 packets received, 0% packets loss
round-trip (ms) min/avg/max = 0/1/16
$
```

Abnormal Execution

```
$ ping 130.25.36.8 ; Executes PING command
PING 130.25.36.8: 56 data bytes
                                           ;Enter Ctrl+C Key to cancel.
----130.25.36.8 PING Statistics----
9 packets transmitted, 0 packets received, 100% packets loss
$
```

Refer to operating system documentation for your host computer for details about using the host computer's PING command.

2-12 Replacing an Ethernet Unit

This section describes how to replace a CS1D Ethernet Unit. Refer to the operation manual for the respective Unit for the replacement procedures for CPU Units and other PLC Units.

Systems in Which the Power Can Be Turned OFF

The CS1D Ethernet Unit has the following settings that must be made on the Ethernet Unit

- Unit number (rotary switch)
- Node address (rotary switches)

The IP address and other settings are kept in non-volatile memory in the CPU Unit.

1,2,3...

1. Turn OFF the power supply to the system.
2. Remove the communications cable from the Ethernet Unit and remove the Unit from the Backplane.
3. Set the unit number and node address on the new Ethernet Unit to the same values as on the Ethernet Unit being replaced.
4. Mount the new Ethernet Unit to the Backplane and connect the communications cable.
5. Turn ON the power supply to the system.

6. Check to be sure the RUN indicator on the new Ethernet Unit lights and that communications are actually restarted.

Systems in Which the Power Can Not Be Turned OFF

1,2,3...

1. To minimize the time required for Unit replacement, set the unit number and node address on the new Ethernet Unit to the same values as on the Ethernet Unit being replaced in advance.
2. Go online from the IO Table Window in CX-Programmer (version 4.0 or higher) and select the Ethernet Unit in the IO Table Window.

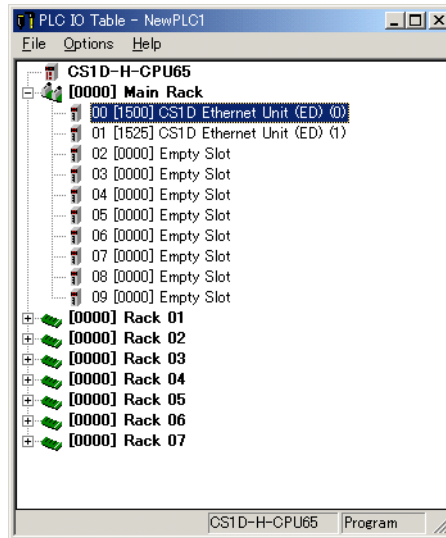

3. Right-click and select **Hot Swap** from the following pop-up menu.

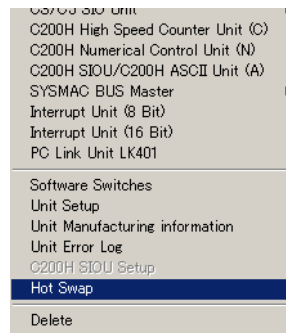

The following Hot Swap Dialog Box will be displayed.

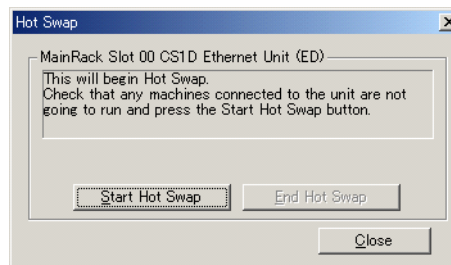

4. Click the **Start Hot Swap** Button in the dialog box and then click the **OK** Button in the following dialog box.

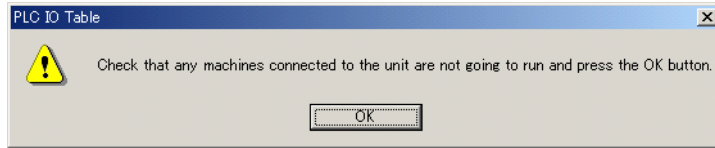

- 5. Confirm that the RUN indicator goes out on the Ethernet Unit. The Online Replacement Dialog Box should change at this time as shown below.

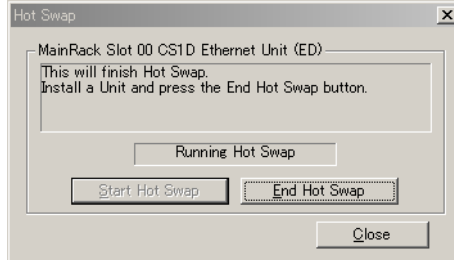

- 6. Remove the communications cable from the Ethernet Unit and remove the Unit from the Backplane.
- 7. Mount the new Ethernet Unit to the Backplane and connect the communications cable.
- 8. Click the **Stop Hot Swap** Button in the Hot Swap Dialog Box.
- 9. Check to be sure the RUN indicator on the new Ethernet Unit lights and that communications are actually restarted. The Online Replacement Dialog Box should change at this time as shown below.

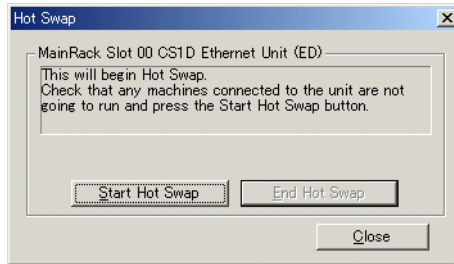

SECTION 3

CX-Programmer Unit Setup

This section describes how to install the Ethernet Unit and make the initial settings required for operation.

3-1	Setup	52
3-2	FINS/TCP	53

3-1 Setup

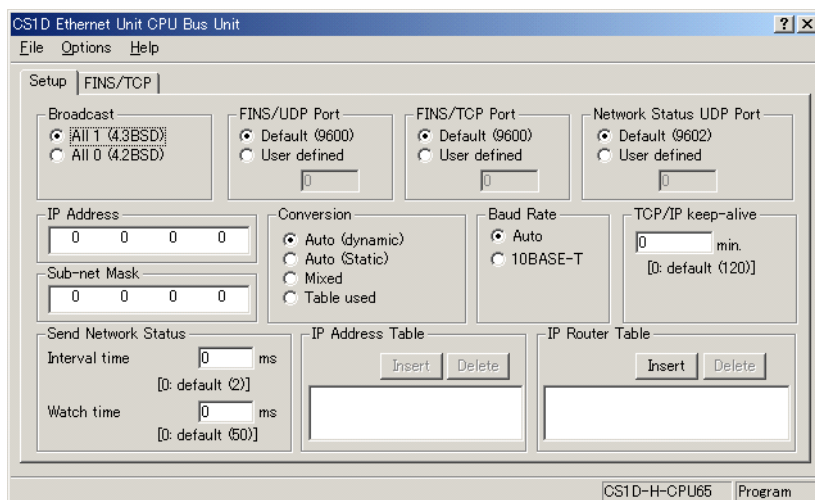

Item	Contents	Default
Broadcast	Set the method for specifying IP addresses for broadcasting in FINS/UDP. <ul style="list-style-type: none"> All 1 (4.3BSD): Broadcast with host number set to all ones. All 0 (4.2BSD): Broadcast with host number set to all zeros. Normally the default setting should be used.	All 1 (4.3BSD)
IP Address	Set the local IP address for the Ethernet Unit.	0.0.0.0 (FINS node address 192.168.250.)
Sub-net Mask	Set the subnet mask for the Ethernet Unit. This is required if a method other than the IP address table method is used for address conversion.	0.0.0.0 (default net mask for IP address setting)
FINS/UDP Port	Specify the local UDP port number to be used for the FINS communications service. The UDP port number is the number used for UDP identification of the application layer (i.e., the FINS communications service in this case). <ul style="list-style-type: none"> Default (9600) User defined (Setting range: 1 to 65535) 	9,600
FINS/TCP Port	Specify the local TCP port number to be used for the FINS communications service. The TCP port number is the number used for TCP identification of the application layer (i.e., the FINS communications service in this case). <ul style="list-style-type: none"> Default (9600) User defined (Setting range: 1 to 65535) 	9,600
Network Status UDP port	Specify the local UDP port number to be used to send network status. The UDP port number is the number used for UDP identification of the application layer (i.e., the network status send service in this case). <ul style="list-style-type: none"> Default (9602) User defined (Setting range: 1 to 65535) Note Do not set the same port number as set for the FINS/UDP port (default: 9600)	9602
Send Network Status: Interval time	Specify the interval for the network status send service to send network status. The default setting can normally be used. Change the setting when it's necessary to adjust the network load. <ul style="list-style-type: none"> Default (2 ms) User defined (Setting range: 1 to 254 ms) 	Default (2 ms)

Item	Contents	Default
Send Network Status: Watch time	Specify the time to determine if a node has left the network, i.e., if status is not received after the time set here passes from when the network status is sent. The default setting can normally be used. Change the setting when it's necessary to adjust the network load. <ul style="list-style-type: none"> • Default (50 ms) • User defined (Setting range: 1 to 255 ms) 	Default (50 ms)
Conversion	Select any of the following as the method for finding and converting IP addresses from FINS node addresses. (Enabled for FINS/UDP only.) <ul style="list-style-type: none"> • Automatic generation (dynamic) • Automatic generation (static) • IP address table method • Combined method 	Auto (dynamic)
Baud Rate	Select the Ethernet baud rate for the Ethernet Unit. Select either automatic detection or 10Base-T. (For 100Base-TX, select automatic detection.)	Auto
TCP/IP KEEP ALIVE function	Set the Liveness-Checking Interval. When socket services using either FINS/TCP or TCP/IP are used, the connection will be terminated if there is no response from the remote node (either a server or client) within the time set here. (Enabled for socket services using FINS/TCP or TCP/IP only.) Setting range: 0 to 65,535 minutes This setting applies to the KEEP ALIVE setting for each connection set with the FINS/TCP tab.	0 (120 minutes)
IP Address Table	Set the IP address table that defines the relationship between FINS node addresses and IP addresses. With FINS/UDP, this is enabled only when the IP address table method is set as the IP address conversion method.	None
IP Router Table	Set when the Ethernet Unit is to communicate through the IP router with nodes on another IP network segment.	None

3-2 FINS/TCP

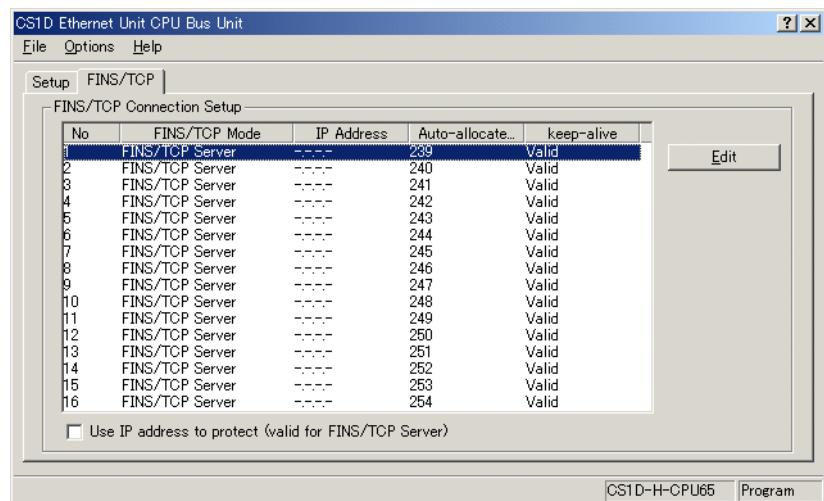

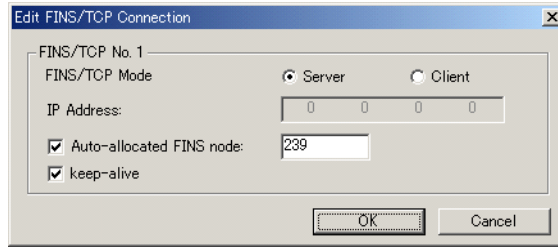

FINS/TCP Connection Setup

Item	Contents	Default
No.	Shows the connection number. This is a network API used when TCP is used for the FINS communications service. It corresponds to a socket in the socket services. Up to 16 can be used at a time, and they are identified by connection numbers 1 to 16. The Ethernet Unit can thus simultaneously execute the FINS communications service by TCP with up to 16 remote nodes.	
Use IP address to protect	When this option is selected, if the Ethernet Unit is set for use as a server, and if a connection number other than 00.00.00.00 is set for a destination IP address, any connection request from other than the number set for that IP address will be denied. Select this option to prevent faulty operation (by FINS commands) from specific nodes from affecting the PLC.	Not protected

The following settings can be made for each connection number.

Item	Contents	Default
FINS/TCP Mode	For each connection number, this setting specifies the Ethernet Unit for use as either a server or a client. <ul style="list-style-type: none"> When the Ethernet Unit is used as a server: The Ethernet Unit opens a connection with that connection number and waits for service requests (FINS commands) from clients. Connection numbers are used in ascending order and allocated to clients in the order connections are made. When the Ethernet Unit is used as a client: The Ethernet Unit establishes a connection with the server set as the destination IP address. Once the connection has been established, FINS/TCP is used for FINS communications. 	Server
IP Address	<ul style="list-style-type: none"> When the Ethernet Unit is used as a server: If the option is selected to use IP addresses to protect, set the IP addresses as required at clients from which connection is permitted. If not set for those connections, the default setting of 0.0.0.0 can be used. When the Ethernet Unit is used as a client: Set the IP address for the remote Ethernet Unit (i.e., the server) that is to be connected by FINS/TCP. It is required that an IP address be set for the remote Ethernet Unit. 	0.0.0.0

Item	Contents	Default
Auto allocated FINS node	<p>If the client (normally a personal computer) application supports FINS/TCP, and if FINS node addresses are not fixed, the client will take 0 as its node address. Then, when a FINS command arrives, the number set here (from 239 to 254) will automatically be allocated as the client's FINS node address.</p> <p>For details on automatic allocation of FINS node addresses, refer to the <i>Operation Manual Construction of Applications</i>.</p>	From 239 to 254, for connection numbers 1 to 16
keep-alive	<p>For each connection number, set whether or not the remote node connection check function is to be used for the FINS/TCP server and client.</p> <p>If the keep-alive box is checked here, then, when the remote node goes without responding for longer than the watch set in the Setup, the connection will be terminated. If a remote node turns OFF without warning, the connection will remain open indefinitely, so this option should be used whenever possible.</p>	Use

For details, refer to *SECTION 6 FINS Communications Service* in the *Operation Manual Construction of Networks*.

SECTION 4

Ethernet Unit Memory Allocations

This section describes the words allocated in the CIO Area and the DM Area for Ethernet Units.

4-1	CIO Area Allocations	58
4-2	DM Area Allocations	65
4-3	Auxiliary Area Data	66

4-1 CIO Area Allocations

With Duplex Communications Units, CIO Area words are allocated to both the Primary Unit and Secondary Unit. Information is stored in the allocated words at the offsets shown below from the first word allocated to each Unit. The value of the first word, n, can be calculated as follows:

$$n = \text{CIO } 1500 + (25 \times \text{Unit number}) \text{ (See note.)}$$

Note In the above formula, use the unit number actually set on the Primary Unit and use one larger than the unit number set on the Secondary Unit.

Offset	Bit 15	8	7	0	Data direction	Related communications services
n	Unit Control Switch			CPU Unit to Ethernet Unit		Memory Card Unit Setup
n+1	Network Participation Status			Ethernet Unit to CPU Unit		Network Status Transmission
n+16	Service Status					Communications services
n+17	Error Status					All error conditions
n+18	Memory Card Unit Setup Error Code					Memory Card/Unit Setup
n+19	(Not used.)					
n+20						
n+22	FINS/TCP Connection Status			Ethernet Unit to CPU Unit		FINS Communications
n+23	(Not used.)					
n+24						

The software switches in the CX-Programmer can also be used to check the status of the CS1D Ethernet Unit. The following tabs are displayed on the CX-Programmer for CS1D Ethernet Unit software switches.

- Service status (link status, duplex status)
- Error information (other than for the Memory Card Unit Setup)
- FINS/TCP connection status
- Network participation status

This section describes the meaning of each item. Refer also to the page indicated above for communications services for further information on application methods.

Unit Control Bits (CPU Unit to Ethernet Unit)

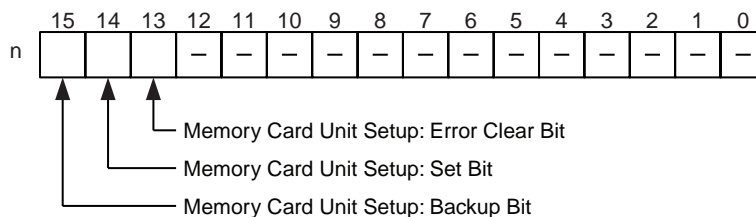

Bit	Switch	Status	Manipulated by	Unit operation	Reference
0 to 12	(Not used.)	---	---	---	---
13	Memory Card Unit Setup: Error Clear Bit	ON	User	Turn ON to clear errors for the Memory Card Unit Setup function.	<i>Appendix G Using a Memory Card Text File to Set Up an Ethernet Unit</i>
		OFF	Unit	Will turn OFF when errors have been cleared.	
14	Memory Card Unit Setup: Set Bit	ON	User	Turn ON to set up the Unit using the Memory Card Unit Setup function.	
		OFF	Unit	Will turn OFF when setup has been completed.	
15	Memory Card Unit Setup: Backup Bit	ON	User	Turn ON to back Unit settings for the Memory Card Unit Setup function.	
		OFF	Unit	Will turn OFF when backup has been completed.	

Memory Card Unit Setup: Error Clear Bit (Bit 13)

Errors that have occurred for the Memory Card Unit Setup function will be cleared when bit 13 is turned ON. This bit will turn OFF automatically when the errors have been cleared. Do not attempt to change the status of this bit until it turns OFF automatically.

Memory Card Unit Setup: Set Bit (Bit 14)

The Ethernet Unit will be set up using the text file on the Memory Card when bit 14 is turned ON. This bit will turn OFF automatically when the setup has been completed. Do not attempt to change the status of this bit until it turns OFF automatically.

Memory Card Unit Setup: Backup Bit (Bit 15)

The Ethernet Unit setup will be backed up to a text file on the Memory Card when bit 15 is turned ON. This bit will turn OFF automatically when the backup has been completed. Do not attempt to change the status of this bit until it turns OFF automatically.

Network Participation Status (Ethernet Unit to CPU Unit)

The numbers in the body of the following table are the node address. The status of the corresponding bit for each address indicates the following:

- OFF: Node not participating in network
- ON: Node participating in network
- : Not used.

Word	15	14	13	12	11	10	09	08	07	06	05	04	03	02	01	00
n+1	16	15	14	13	12	11	10	9	8	7	6	5	4	3	2	1
n+2	32	31	30	29	28	27	26	25	24	23	22	21	20	19	18	17
n+3	48	47	46	45	44	43	42	41	40	39	38	37	36	35	34	33
n+4	64	63	62	61	60	59	58	57	56	55	54	53	52	51	50	49
n+5	80	79	78	77	76	75	74	73	72	71	70	69	68	67	66	65
n+6	96	95	94	93	92	91	90	89	88	87	86	85	84	83	82	81
n+7	112	111	110	109	108	107	106	105	104	103	102	101	100	99	98	97
n+8	128	127	126	125	124	123	122	121	120	119	118	117	116	115	114	113
n+9	144	143	142	141	140	139	138	137	136	135	134	133	132	131	130	129
n+10	160	159	158	157	156	155	154	153	152	151	150	149	148	147	146	145
n+11	176	175	174	173	172	171	170	169	168	167	166	165	164	163	162	161
n+12	192	191	190	189	188	187	186	185	184	183	182	181	180	179	178	177
n+13	208	207	206	205	204	203	202	201	200	199	198	197	196	195	194	193
n+14	224	223	222	221	220	219	218	217	216	215	214	213	212	211	210	209
n+15	240	239	238	237	236	235	234	233	232	231	230	229	228	227	226	225
n+16	---	---	254	253	252	251	250	249	248	247	246	245	244	243	242	241

Service Status (Ethernet Unit to CPU Unit)

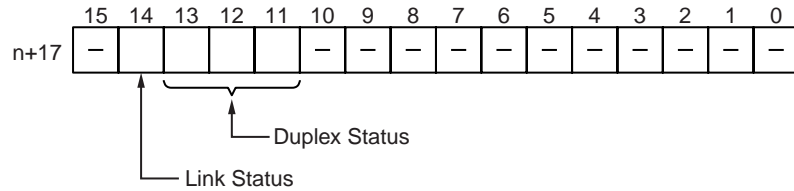

Bit	Name	Status	Manipulated by	Unit operation	Reference
0 to 10	(Not used.)	---	---	---	---
11	Duplex Status: Primary/Secondary	ON	Unit	ON when operating as Primary Unit in Duplex Mode.	
		OFF	Unit	OFF when operating as Secondary Unit in Duplex Mode.	
12	Duplex Status: Network Participation	ON	Unit	ON when participating in network in Duplex Mode.	
		OFF	Unit	OFF when not participating in network, but set in Duplex Mode.	
13	Duplex Status: Mode	ON	Unit	ON when operating in Duplex Mode.	
		OFF	Unit	OFF when operating Simplex Mode.	
14	Link Status	ON	Unit	ON while a link is established with the hub.	---
		OFF	Unit	OFF when the link with the hub is terminated.	
15	(Not used.)	---	---	---	---

Duplex Status: Primary/Secondary (Bit 11)

This bit is ON if the Ethernet Unit is set in Duplex Mode and operating as the Primary Unit. It is OFF if the Unit is set in Duplex Mode and operating as the Secondary Unit. The DPL indicator on the Ethernet Unit shows this status as follows:

- Lit:
Operating as Primary Unit in Duplex Mode. (Bit 11 = ON)
- Flashing:
Operating as Second Unit in Duplex Mode. (Bit 11 = OFF)

Duplex Status: Network Participation (Bit 12)

This bit is ON if the Ethernet Unit is set in Duplex Mode and is participating in the network. It is OFF is the Unit is not participating in the network.

Duplex Status: Mode (Bit 13)

This bit is ON if the Ethernet Unit is set in Duplex Mode and OFF if the Unit is set in Simplex Mode. The DPL indicator on the Ethernet Unit shows this status as follows:

Not lit: Operating in Simplex Mode (Bit 13 = OFF)

Link Status (Bit 14)

This bit is ON if a link has been established with the hub. It is OFF if there is no link established with the hub.

Error Status (Ethernet Unit to CPU Unit)

The status of errors that occur at the Ethernet Unit is reflected as shown in the following diagram.

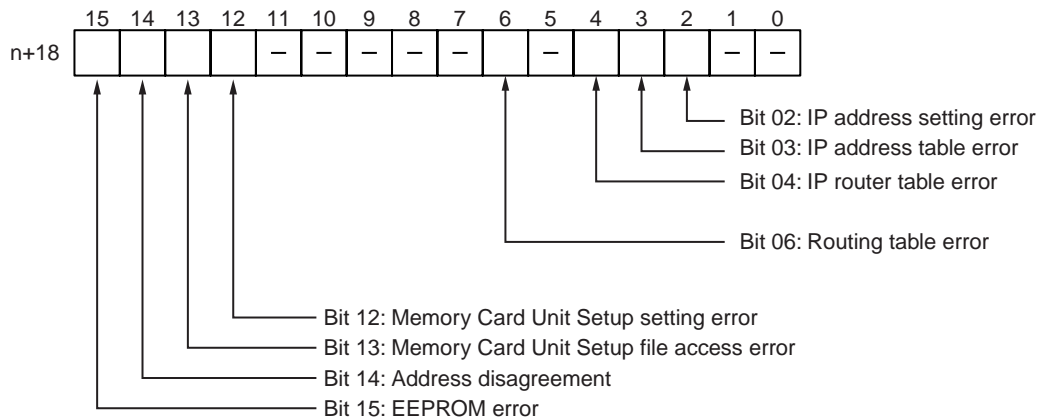

Bit	Error	Status	Manipulated by	Unit operation
0 to 1	(Not used.)	---	---	---
2	IP address setting error	ON	Unit	ON if any of the following conditions apply to the IP address. <ul style="list-style-type: none"> • All bits in the host ID are 0 or 1. • All bits in the network ID are 0 or 1. • All bits in the subnet ID are 1. • The IP address begins with 127 (0x7F)
		OFF	Unit	OFF when the IP address is normal.
3	IP address table error	ON	Unit	ON if the IP address table information is incorrect.
		OFF	Unit	OFF when the IP address table is normal.
4	IP router table error	ON	Unit	ON if the IP router table information is incorrect.
		OFF	Unit	OFF when the IP address table is normal.
5	(Not used.)	---	---	---
6	Routing table error	ON	Unit	ON if the routing table information is incorrect.
		OFF	Unit	OFF when the routing table is normal.
7 to 11	(Not used.)	---	---	---
12	Memory Card Unit Setup setting error	ON	Unit	ON when there is an error in a setting for the Memory Card Unit Setup function.
		OFF	Unit	OFF when the setup is performed correctly or the error is cleared with the Memory Card Unit Setup Error Clear Bit.
13	Memory Card Unit Setup file access error	ON	Unit	ON when there is an access error for the Memory Card Unit Setup function. An error code will be stored in the Memory Card Unit Setup Error Code if this error occurs.
		OFF	Unit	OFF when the setup is performed correctly or the error is cleared with the Memory Card Unit Setup Error Clear Bit.
14	Address disagreement	ON	Unit	ON if the remote IP address is set to automatic generation but the local IP address host number and FINS node address do not agree.
		OFF	Unit	OFF under all other circumstances.
15	EEPROM error	ON	Unit	ON if an error has occurred in the EEPROM memory.
		OFF	Unit	OFF when the EEPROM memory is normal.

Error (Ethernet Unit to CPU Unit)

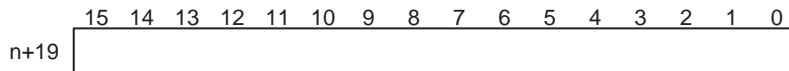

When the Memory Card Unit Setup Setting Error Bit Is ON

The line number of the setting with the error in the setup file is stored in hexadecimal.

When the Memory Card Unit Setup Access Error Bit Is ON

One of the following error codes is stored depending on the status of the Memory Card or setup file.

Error code	Meaning
0000	Normal
2201	Execution is not possible because an operation is already being performed. (More than one control bit for the Memory Card Unit Setup function has turned ON at the same time.)
2006	So such file (Either the Memory Card or a setup file is missing.)
2101	Write-protected via switch setting.
2103	Too many files (An attempt was made to create more than the registered number of files.)
2301	No file device (A Memory Card is not inserted.)
250F	An access error occurred, such as a damaged file device (e.g., Memory Card).

FINS/TCP Connection Status (Ethernet Unit to CPU Unit)

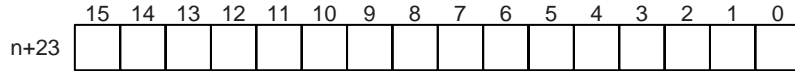

These bits show the status of FINS/TCP connections.

Bit	Switch	Status	Manipulated by	Unit operation	Reference
0	FINS/TCP Connection No.1	ON	Unit	Turned ON by the Unit when a connection is established.	<i>SECTION 6 FINS Communications Service</i>
		OFF	Unit	Turned OFF by the Unit when the connection is terminated.	
1	FINS/TCP Connection No.2	ON	Unit	Turned ON by the Unit when a connection is established.	
		OFF	Unit	Turned OFF by the Unit when the connection is terminated.	
to	to	to	to	to	
14	FINS/TCP Connection No.15	ON	Unit	Turned ON by the Unit when a connection is established.	
		OFF	Unit	Turned OFF by the Unit when the connection is terminated.	
15	FINS/TCP Connection No.16	ON	Unit	Turned ON by the Unit when a connection is established.	
		OFF	Unit	Turned OFF by the Unit when the connection is terminated.	

4-2 DM Area Allocations

With Duplex Communications Units, DM Area words are allocated to both the Primary Unit and Secondary Unit. The various kinds of data are stored in the offset positions shown in the following diagram, from the beginning word in the area for each Unit. The beginning word *m* is calculated by the following equation:

$$\text{First word, } m = D30000 + (100 \times \text{unit number})$$

Note In the above formula, use the unit number actually set on the Primary Unit and use one larger than the unit number set on the Secondary Unit.

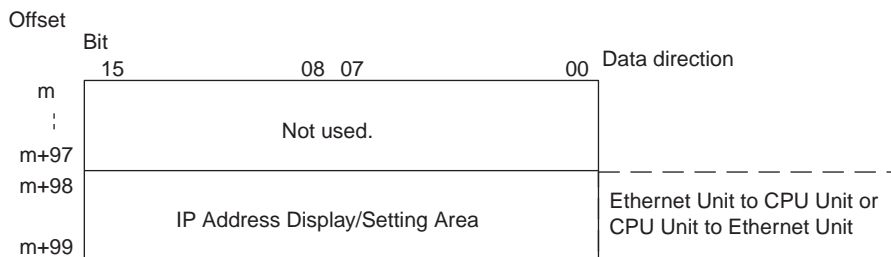

IP Address Display/Setting Area

	15	14	13	12	11	10	9	8	7	6	5	4	3	2	1	0
m+98	(1)				(2)				(3)				(4)			
m+99	(5)				(6)				(7)				(8)			

IP address: (1)(2).(3)(4).(5)(6).(7)(8) (Hex)

If the local IP address in the CPU Bus Unit System Setup is set to a value other than 00.00.00.00, this area (words *m+98* and *m+99*) will act as an IP Address Display Area and the local IP address set in the CPU Bus Unit System Setup will be read and stored here when the power is turned ON or the Unit restarted.

If the local IP address in the CPU Bus Unit System Setup is set to 00.00.00.00 (the default setting), this value is read by the Ethernet Unit when the power is turned ON or the Unit restarted and is used as the local IP address.

If this setting and the IP address in the Unit Setup are both set to 00.00.00.00, the default IP address will be used. The default IP addresses are as follows:

Primary Unit: 192.168.250.*node_address*

Secondary Unit: 192.168.251.*node_address*

Refer to SECTION 5 Determining IP Addresses for information on IP addresses.

Note The various settings for the IP address are used as follows:

- **Default IP Address**
Used to initially connect to the Ethernet Unit. Leave both the settings in the allocated DM Area words and the Unit Setup set to the default value (00.00.00.00) to use the default IP address.
- **IP Address Setting in DM Area**
Use the IP address setting in the DM Area when other Units are to be left at the default settings. This is the easiest way to set just one Unit. This setting is normally made using a Programming Console.
- **IP Address Setting in Unit Setup**
Used when setting other Units as well. The Unit Setup is performed using the CX-Programmer.

Application	Setting device	Setting area	Remarks
Simple operation (i.e., The CPU Unit Bus System Setup is used at its default settings. Only the IP address is set.)	Programming Console (CX-Programmer can also be used.)	Allocated words in the DM Area	The setting in the allocated words in the DM Area is enabled only when the IP address in the CPU Unit Bus System Setup is set to 00.00.00.00. If the IP address in the CPU Unit Bus System Setup is set to a value other than 00.00.00.00, this value is stored in the allocated words in the DM Area.
Operation with the CPU Unit Bus System Setup set as desired.	CX-Programmer	CPU Unit Bus System Setup	The IP address set in the CPU Unit Bus System Setup is stored in the allocated words in the DM Area.

- Note**
- (1) If a value other than 00.00.00.00 is set as the local IP address in the CPU Bus Unit System Setup, even if an IP address is set in the allocated words in the DM Area, it will be overwritten with the setting in the CPU Bus Unit System Setup.
 - (2) It is not possible to set the following IP addresses. If any of these values are set, the ERH indicator will flash.
 - IP addresses where all network number bits are 0 or 1.
 - IP addresses where all host number bits are 0 or 1.
 - IP addresses where all subnet number bits are 1.
 - IP addresses that start with 127 (7F hex, e.g., 127.35.21.16)

4-3 Auxiliary Area Data

The following table and descriptions cover the words and bits in the Auxiliary Area of PLC memory that are related to the Ethernet Unit.

Read-only Bits/Words

Word(s)	Bit(s)	Name	Function	Settings
A202	A20200 to A20207	Communications Port Enabled Flags	Bits A20200 to A20207 turn ON when a network instruction (SEND, RECV, CMND, or PMCR) can be executed with the corresponding port number. Bits 00 to 07 correspond to communications ports 0 to 7.	0: Network communications running 1: No network communications running
A203 to A210	---	Communications Port Completion Codes	These words contain the completion codes for the corresponding port numbers when network instructions (SEND, RECV, CMND, or PMCR) have been executed. Words A203 to A210 correspond to communications ports 0 to 7.	0000: No error Not 0000: Error code
A219	A21900 to A21907	Communications Port Error Flags	Bits A21900 to A21907 turn ON when an error occurred during execution of a network instruction (SEND, RECV, CMND, or PMCR). Bits 00 to 07 correspond to communications ports 0 to 7.	0: Normal end 1: Error end
A302	A30200 to A30215	CPU Bus Unit Initializing Flags	Bits A30200 through A30215 turn ON while the corresponding CPU Bus Units (Units #0 through #15, respectively) are initializing. The bits will turn ON either when power is turned ON or when a CPU Bus Unit Restart Bit (A50100 to A50115) is turned ON. Bits 00 to 15 correspond to unit numbers 0 to F. Bit 00 to 15: 0 to F (unit number)	0: Not initializing 1: Initializing (System will automatically turn the flag OFF when initialization has been completed.)

Word(s)	Bit(s)	Name	Function	Settings
A402	A40203	CPU Bus Unit Setting Error Flag (Non-fatal error)	Bit A40203 is turned ON when the CPU Bus Units actually installed differ from the Units registered in the I/O tables. The ERR/ALM indicator on the front of the CPU Unit will flash, but CPU operation will continue. The unit number of the CPU Bus Unit involved is stored in word A427.	0: No setting error 1: Setting error
	A40207	CPU Bus Unit Error Flag (Non-fatal error)	Bit A40207 is turned ON when an error occurs during the transmission of data between the CPU and CPU Bus Units. The ERR/ALM indicator on the front of the CPU Unit will flash, but CPU operation will continue. The Unit where the error occurred will stop. The unit number of the CPU Bus Unit involved is stored in word A417.	0: No unit number error 1: Unit number error
A403	A40300 to A40308	Memory Error Location	When a memory error occurs, the Memory Error Flag (A40115) is turned ON and one of the following flags is turned ON to indicate the memory area where the error occurred. A40300: User program A40304: PLC Setup A40305: Registered I/O Tables A40307: Routing Table A40308: CPU Bus Unit Settings The ERR/ALM indicator on the front of the CPU Unit will light and CPU operation will stop.	0: Normal 1: Error
A410	A41000 to A41015	CPU Bus Unit Number Duplication Flags	The Duplication Error Flag (A40113) will be turned ON when a CPU Bus Unit's unit number has been duplicated. Bits 00 to 15 correspond to unit numbers 0 to F. The ERR/ALM indicator on the front of the CPU Unit will light and CPU operation will stop.	0: No duplication 1: Duplication
A417	A41700 to A41715	CPU Bus Unit Error, Unit Number Flags	When an error occurs in a data exchange between the CPU Unit and a CPU Bus Unit, the CPU Bus Unit Error Flag (A40207) are turned ON. Bits 00 to 15 correspond to unit numbers 0 to F. The ERR/ALM indicator on the front of the CPU Unit will flash, but CPU operation will continue.	0: No error 1: Error
A427	A42700 to A42715	CPU Bus Unit Setting Error, Unit Number Flags	When a CPU Bus Unit Setting Error occurs, A40203 and the corresponding flag in A427 are turned ON. Bits 00 to 15 correspond to unit numbers 0 to F. The ERR/ALM indicator on the front of the CPU Unit will flash, but CPU operation will continue.	0: No setting error 1: Setting error

■ Duplex Ethernet Settings

Word(s)	Bit(s)	Name	Function	Settings
A027	A02700 to A02715	Communications Unit Duplex Operation Flag	When the Unit is performing duplex operation, the corresponding flag in A027 is turned ON. Bits 00 to 15 correspond to unit numbers 0 to F. Bit 00 to 15: 0 to F (unit number)	OFF: Not duplex operation ON: Duplex operation
A316	A31603	Duplex Communications Error Flag	Bit A31603 turns ON when there is an error in any of the Duplex Communications Units. (Refer to A434 to A437 for details on the error.)	OFF: No error ON: Error
A434	A43400 to A43415	Duplex Communications Detection Error Flag	When there is a problem in the Communications Units set for duplex operation, the corresponding flag in A434 is turned ON. The possible causes are a missing Communications Unit, a Communications Unit that does not support duplex operation, or an incorrectly set unit number. Bits 00 to 15 correspond to unit numbers 0 to F. Bit 00 to 15: 0 to F (unit number)	OFF: No error ON: Error
A435	A43500 to A43515	Duplex Communications Verification Error Flag	When the settings are not the same for Communications Units set for duplex operation, the corresponding flag in A435 is turned ON. Refer to the operation manual for the relevant Communications Unit for details on settings. Bits 00 to 15 correspond to unit numbers 0 to F. Bit 00 to 15: 0 to F (unit number)	OFF: No error ON: Error
A436	A43600 to A43615	Duplex Communications Switchover Flag (non-fatal communications error)	When there is an error in the Primary Communications Unit, the corresponding flag in A436 is turned ON. The Secondary Communications Unit will continue communications. Bits 00 to 15 correspond to unit numbers 0 to F. Bit 00 to 15: 0 to F (unit number)	OFF: No error ON: Error
A437	A43700 to A43715	Duplex Communications Unit Standby Error Flag (non-fatal communications error)	When there is an error in the Secondary Communications Unit, the corresponding flag in A437 is turned ON. The Primary Communications Unit will continue communications. Bits 00 to 15 correspond to unit numbers 0 to F. Bit 00 to 15: 0 to F (unit number) The bit will turn OFF when the Communications Unit with the error is replaced online.	OFF: No error ON: Error

Word(s)	Bit(s)	Name	Function	Settings
A042 to A049		Duplex Communications Switchover Cause	<p>When there is an error in a Communications Unit, an 8-bit error codes will be stored in the bits corresponding to the unit number shown below</p> <p>A04200 to A04207: 0 (unit number) A04208 to A04215: 1 (unit number) A04300 to A04307: 2 (unit number) A04308 to A04315: 3 (unit number) A04400 to A04407: 4 (unit number) A04408 to A04415: 5 (unit number) A04500 to A04507: 6 (unit number) A04508 to A04515: 7 (unit number) A04600 to A04607: 8 (unit number) A04608 to A04615: 9 (unit number) A04700 to A04707: A (unit number) A04708 to A04715: B (unit number) A04800 to A04807: C (unit number) A04808 to A04815: D (unit number) A04900 to A04907: E (unit number) A04908 to A04915: F (unit number)</p> <p>The bits for the Primary Unit correspond to the unit number set on the Unit. The bits for the Secondary Unit correspond to the unit number one higher than the number set on the Unit.</p> <p>If an error code is set, the corresponding bit in A436 (Duplex Communications Switchover Flag) will also turn ON.</p>	<p>Error code (hex)</p> <p>00: No error 80: Unit WDT error Other: Not used</p>

■ Online Unit Replacement Information

Word(s)	Bit(s)	Name	Function	Settings
A261	A26110	Online Unit Replacement Flag	A26110 will turn ON when a Basic I/O Unit, Special I/O Unit, or CPU Bus Unit is being replace online on the CPU Rack, Expansion Rack, or Long-distance Expansion Rack. The I/O tables cannot be created while this bit is ON and an I/O table creation error will occur if an attempt is made to create the I/O tables.	OFF: Not performing online replacement ON: Performing online replacement
A034 to A041		Online Unit Replacement Slot	The bit corresponding to the slot for which online replacement is being performed will turn ON. A03400 to A03404: Slot number on CPU Rack (0 to 4) A03405 to A03407: Slot number on CPU Rack (5 to 7) (Single-CPU Systems only) A03500 to A03508: Slot number on Expansion Rack 1 (0 to 8) A03600 to A03608: Slot number on Expansion Rack 2 (0 to 8) . . . A04100 to A04108: Slot number on Expansion Rack 7 (0 to 8)	OFF: Not performing online replacement ON: Performing online replacement

Read/Write Bits (User Settings)

Word	Bits	Name	Description	Settings
A501	A50100 to A50115	CPU Bus Unit Restart Bits	The CPU Bus Unit will be restarted when the corresponding bit is turned ON. Bits 00 to 15 correspond to unit numbers 0 to F. Bit 00 to 15: 0 to F (unit number) The CPU Bus Unit Initializing Flags (A30200 to A30215) will turn ON when initialization of the Units begins and turn OFF when it is completed.	OFF to ON: Unit restarted. Automatically turned OFF by system after restart processing has been completed.

SECTION 5

Determining IP Addresses

This section explains how to manage and use IP addresses.

5-1	IP Addresses	72
5-1-1	IP Address Configuration	72
5-1-2	Allocating IP Addresses	72
5-1-3	Ethernet Unit IP Address Settings	73
5-1-4	Subnet Masks	73
5-2	IP Addresses in FINS Communications	74
5-2-1	Specifying Nodes in FINS Communications Services	74
5-2-2	Pairing Addresses in Internal Tables	76
5-2-3	Application Examples	80
5-2-4	Related Products and Communications/Setting Methods	82
5-2-5	Pairing IP Addresses and FINS Node Addresses	84
5-3	Private and Global Addresses	84
5-3-1	Private and Global Addresses	84
5-3-2	Using a Private Address for the Ethernet Unit	86
5-3-3	Ethernet Unit with a Global Address	87

5-1 IP Addresses

Ethernet networks use IP addresses for communications. IP addresses identify both the Ethernet network and the node (host computer, Ethernet Unit, etc.). IP addresses must be set and controlled so that they are not duplicated.

5-1-1 IP Address Configuration

IP addresses are made up of 32 bits of binary data divided into four 8-bit fields called octets. These four octets provide the network number (net ID) and host number (host ID). The network number identifies the network, and the host number identifies the node (or host) on the network.

The network numbers in an IP address are divided into three classes, A, B, and C, so that the address system can be selected according to the scale of the network. (Classes D and E are not used.) The configuration of the IP address for each of these classes is shown in the following diagram.

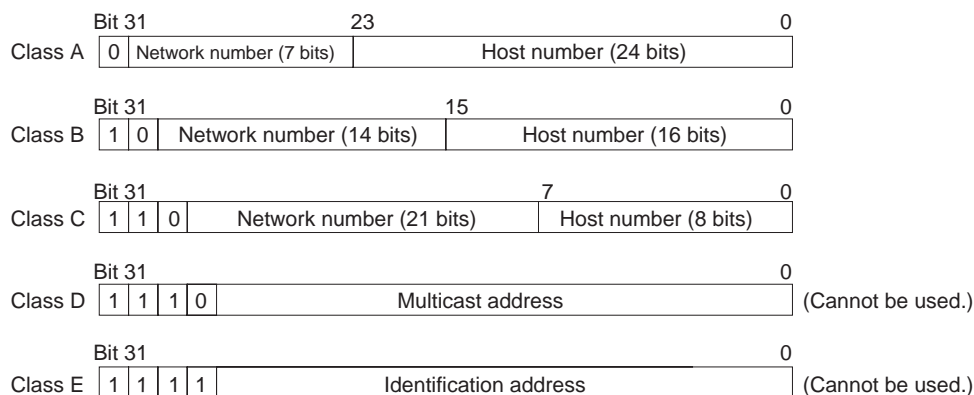

The number of networks in each class and the number of nodes possible on the network differ according to the class.

Class	Number of networks	Number of hosts
Class A	Small	$2^{24}-2$ max. (16,777,214 max.)
Class B	Medium	$2^{16}-2$ max. (65,534 max.)
Class C	Large	2^8-2 max. (254 max.)

The 32 bits of an IP address are divided into four sections of eight bits each, and expressed as a punctuated number. IP addresses are represented by the decimal equivalent of each of the four octets in the 32-bit address, each separated by a period. For example, the binary address 1000010 00111010 00010001 00100000 would be represented as 130.58.17.32.

Note The same network number must be set for every node on the same Ethernet network.

5-1-2 Allocating IP Addresses

A unique IP address must be allocated to nodes on each network or on multiple interconnected networks. IP (Internet Protocol) is a standard communications protocol used throughout the world, and is designed to enable communications between any Ethernet nodes regardless of the networks on which they exist. To achieve this, network numbers are allocated by the Network Solutions, InterNIC Registration Services, to ensure that all Ethernet

5-2 IP Addresses in FINS Communications

5-2-1 Specifying Nodes in FINS Communications Services

With FINS communications services on an Ethernet network, IP addresses, UDP port numbers, and TCP port numbers are paired with FINS node addresses to specify nodes on the network.

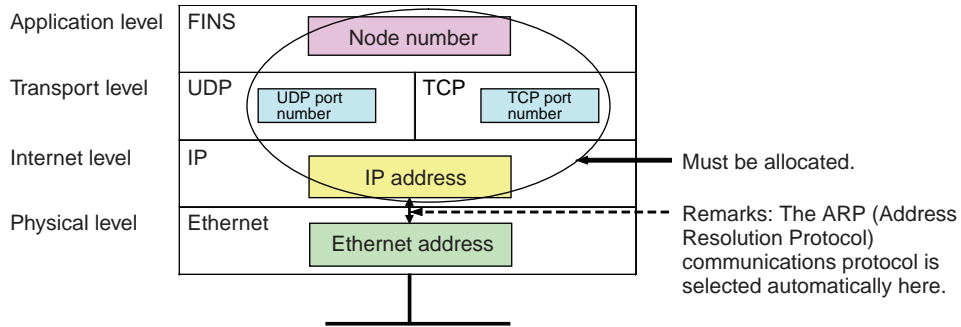

Note Use the “Node No.” rotary switch on the front of the Ethernet Unit to set the FINS node address.

Allocating Addresses to Ethernet Units

Ethernet Unit FINS Message Reception

The IP address, FINS/UDP port number, and FINS/TCP port number set for the Ethernet Unit are mainly used when receiving FINS communications messages.

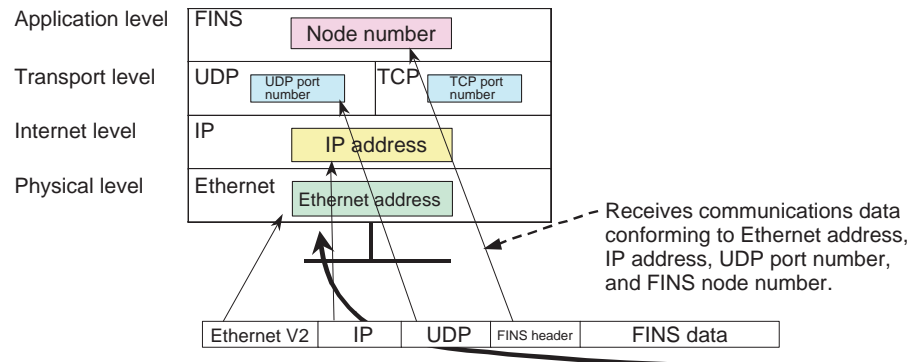

- **Ethernet address:** A fixed number is assigned to each Ethernet Unit and it cannot be changed.
- **IP address:** Either use the default IP address (192.168.250.FINS_node number), or set the address in the word allocated in the DM Area or in the Unit Setup from the CX-Programmer.
- **FINS/UDP port number:** Either use the default FINS/UDP port number (9600) or set the number using the CX-Programmer's Unit Setup.
- **FINS/TCP port number:** Either use the default FINS/TCP port number (9600) or set the number using the CX-Programmer's Unit Setup.
- **FINS node address:** Set the number using the NODE NO. rotary switch on the front of the Ethernet Unit.

Pairing IP Addresses with FINS Node Addresses at Local Nodes

A particular IP address is allocated to each communications node, including Ethernet Units. The IP address must be paired with the FINS node address (1 to 254) by one of the following methods.

Automatic Generation Method (Dynamic/Static)

Set the relation between the IP address and the FINS node address for the Ethernet Unit according to the following equation. If the setting does not conform to this equation, a setting error will be generated and the ERH indicator will flash.

$$\text{FINS node address} = \text{IP address host number}$$

IP Address Table Method and Combined Method

With these methods, the IP address and the FINS node address for the Ethernet Unit have no particular relationship. Set both the FINS node address and the IP address so that they are not duplicated in the network.

When the Ethernet Unit sends a FINS message, it must determine the remote node's IP address, UDP port number, and TCP port number. The relationships between all addresses, such as remote FINS node addresses and IP addresses, are managed by an internal table at the Ethernet Unit.

Remote FINS node address	Remote IP address (Example)	Connection	Remote port number (Example)
1	192.168.250.1	UDP	9600
2	192.168.250.2	UDP	9600
to			
254	192.168.250.254	UDP	9600

Sending Ethernet Unit FINS Messages

When the Ethernet Unit is turned ON or restarted, the internal table is generated automatically from the various settings that have been made. Depending on the setting method used, data such as remote IP addresses are changed dynamically. (Dynamic changes can be prohibited.)

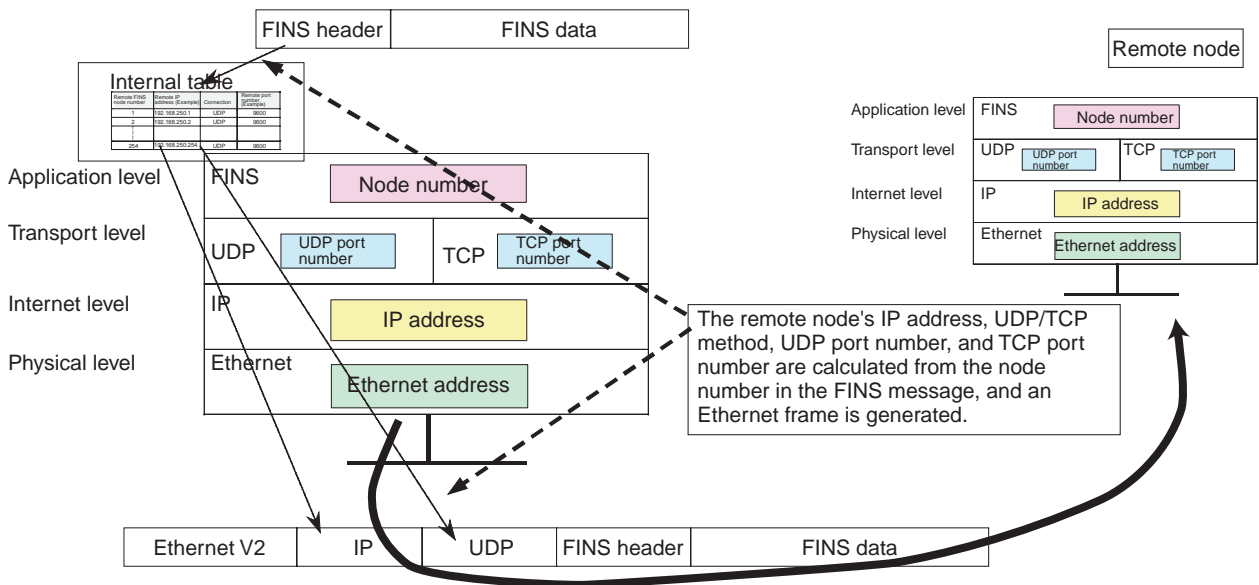

5-2-2 Pairing Addresses in Internal Tables

FINS/UDP Communications Methods

Automatic Generation (Dynamic)

When the Ethernet Unit is turned ON or restarted, the following values are set for addresses in the internal table.

- Remote IP address: Local IP address network number + remote FINS node address
- Remote UDP port number: UDP port number set for local Unit
- Connection method: FINS/UDP

With the dynamic method, data in an internal table that has been generated can be dynamically converted according to FINS messages received from remote nodes. This is enabled when the remote node is a device such as a personal computer and IP addresses are dynamically changed by a method such as DHCP.

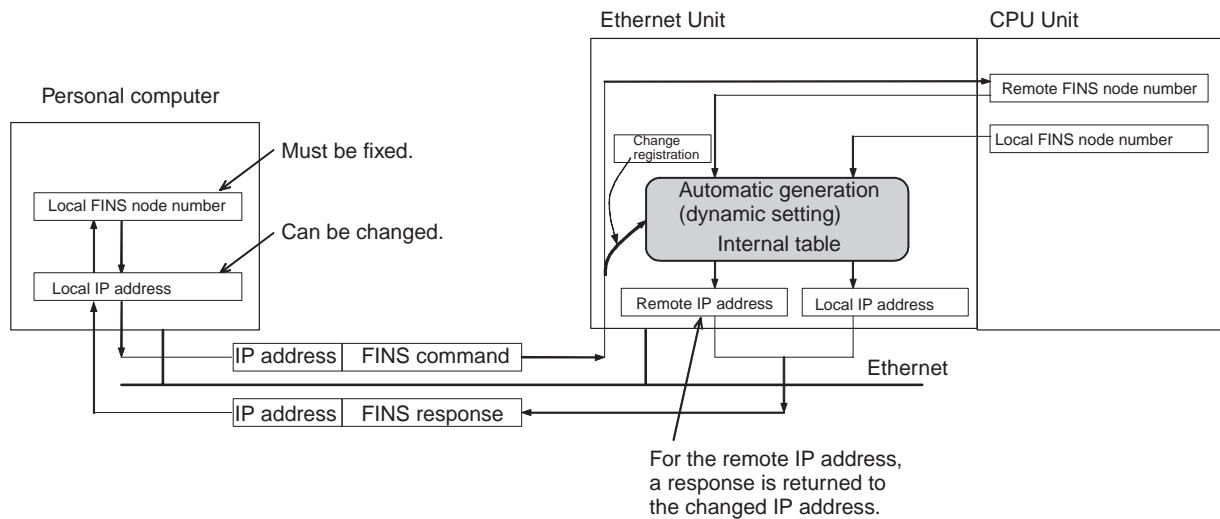

Automatic Generation (Static)

With the static method as well, the following values are set for addresses in the internal table when the Ethernet Unit is turned ON or restarted.

- Remote IP address: Local IP address network number + remote FINS node address
- Remote UDP port number: UDP port number set for local Unit
- Connection method: FINS/UDP

With the static method, however, data in an internal table that has been generated is not freely changed.

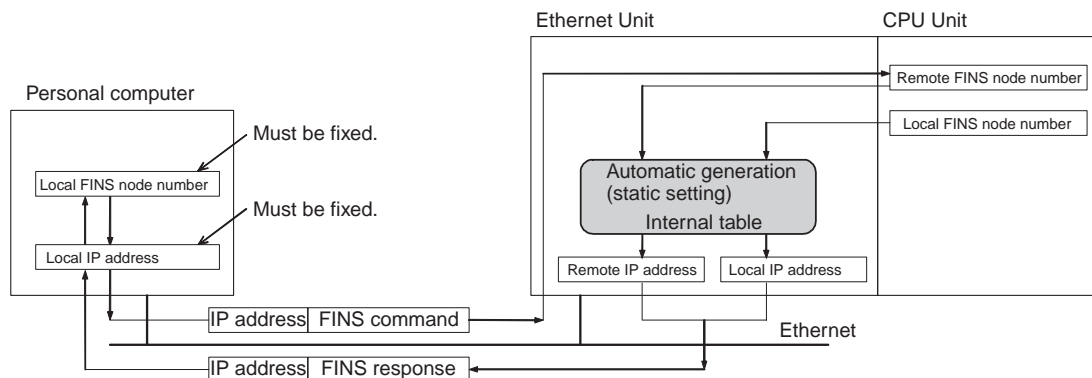

IP Address Table Method

With this method, FINS node addresses are converted to IP addresses based on a correspondence table (IP address table) that is preset in the Unit setup. The IP address table is set using the CX-Programmer in *IP Address Table* under *Settings* in the Unit Setup. It can be registered for nodes in different segments and with different network numbers.

The internal table will be as follows:

- FINS Node Address Registered to IP Address Table

The following address is registered to the internal table.

- Remote IP address: IP address registered to IP address table
- Remote UDP port number: UDP port number set for local Unit
- Connection method: FINS/UDP

- FINS Node Address Not Registered to IP Address Table

The following address is registered to the internal table.

- Remote IP address: 0.0.0.0
- Remote UDP port number: UDP port number set for local Unit
- Connection method: FINS/UDP

With the IP address table method, records of FINS nodes registered to the IP address table are not changed dynamically. For all others node, the data from FINS nodes registered with a remote IP address of 0.0.0.0 can be dynamically changed when the Unit is turned ON or restarted, according to FINS messages received from remote nodes. This can be used effectively when the remote node is a device such as a personal computer and IP addresses are dynamically changed by a method such as DHCP.

Example

When FINS Command is Sent

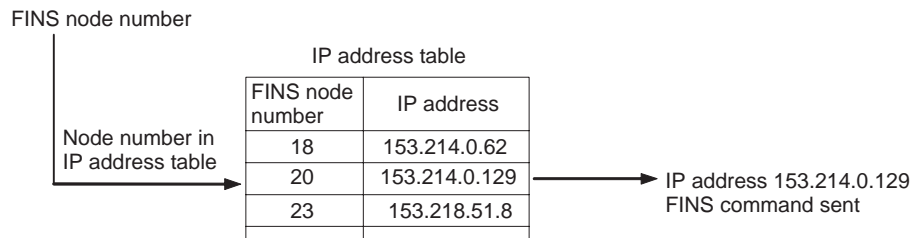

When FINS Command is Received

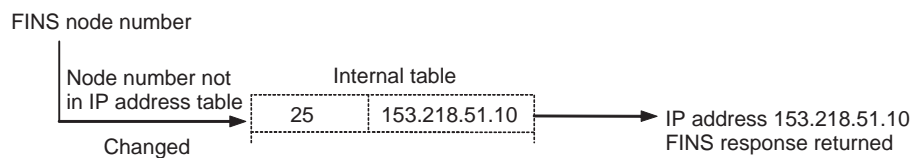

Combined Method

The combined method combines the IP address table method and the automatic generation method (dynamic).

First the IP address table is referenced. Then, if the applicable FINS node address is found, the corresponding IP address is read. If the FINS node address is not found, the IP address is calculated using the automatic generation method (dynamic).

The internal table will be as follows:

- FINS Node Address Registered to IP Address Table

The following address is registered to the internal table.

- Remote IP address: IP address registered to IP address table
- Remote UDP port number: UDP port number set for local Unit

- Connection method: FINS/UDP
- FINS Node Address Not Registered to IP Address Table
The following address is registered to the internal table.
 - Remote IP address: Local IP address network number + FINS node address
 - Remote UDP port number: UDP port number set for local Unit
 - Connection method: FINS/UDP

With the combined method, records of FINS nodes registered to the IP address table are not dynamically changed. For all others nodes, the data from FINS nodes registered with a remote IP address of 0.0.0.0 can be dynamically changed when the Unit is turned ON or restarted, according to FINS messages received from remote nodes. This can be used effectively when the remote node is a device such as a personal computer and IP addresses are dynamically changed by a method such as DHCP.

Example

When FINS Command is Sent

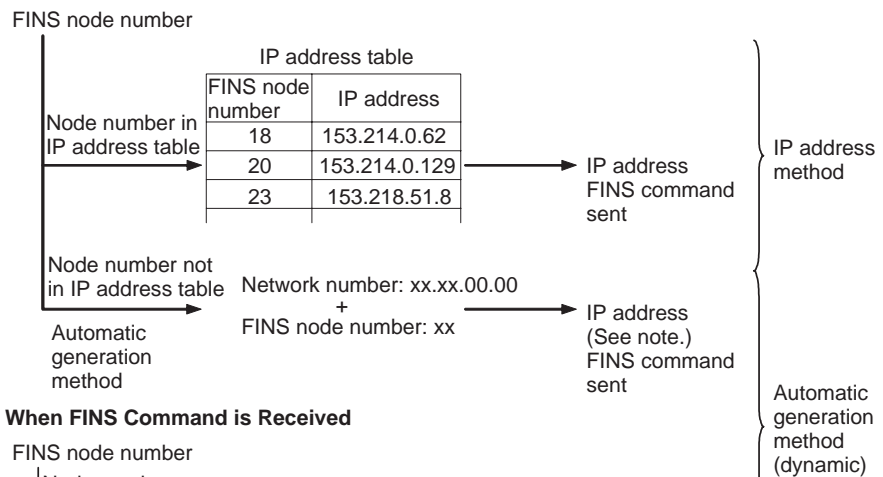

When FINS Command is Received

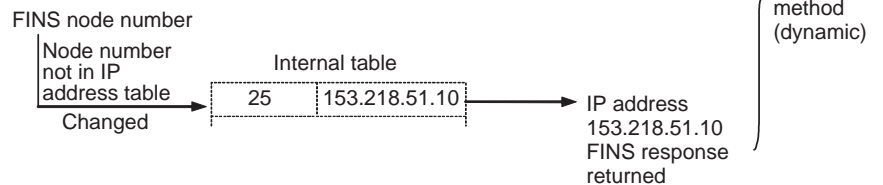

Note When an internal table IP address has been changed with the reception of a FINS command, this is sent to the IP address in the internal table.

FINS/TCP Communications Method

Pairing in the FINS/TCP Method

With the FINS/TCP method, communications are first established for each connection, and then remote FINS node addresses are mutually converted. (See note.) Then FINS message communications are executed. In this way, remote FINS node addresses and remote IP addresses are paired for each connection. Therefore, with the FINS/TCP method, there is no need to set IP address conversions (i.e., pairing FINS node addresses with IP addresses) as with FINS/UDP. All that is required is to use the CX-Programmer's Unit setup to set the remote IP address for each connection.

Note The internal table is changed after connections are established.

Internal Processing

The Ethernet Unit executes the following processing when the FINS/TCP method is used.

Local Device Is FINS/TCP Client

- 1,2,3...
1. Connections are established in TCP/IP protocol with the IP addresses set at the Unit (i.e., the IP address for each connection No.).
 2. The remote node (i.e., the server) is notified of the FINS node address for the local device.
 3. Notification is received from the remote node (i.e., the server) of the remote node's FINS node address.
 4. The Ethernet Unit changes the internal table (FINS node address, IP address, and TCP port number).
 5. FINS messages can then be sent and received.

Local Device Is a FINS/TCP Server

- 1,2,3...
1. A request to open a connection is received in TCP/IP protocol from the remote device (i.e., the client, either a personal computer or an Ethernet Unit), and the connection is established.
 2. Notification is received from the remote node (i.e., the client) of the remote node's FINS node address.
 3. The local device provides notification of the local FINS node address.
 4. The Ethernet Unit changes the internal node correspondence table (FINS node address, IP address, and TCP port number).
 5. FINS messages can then be sent and received.

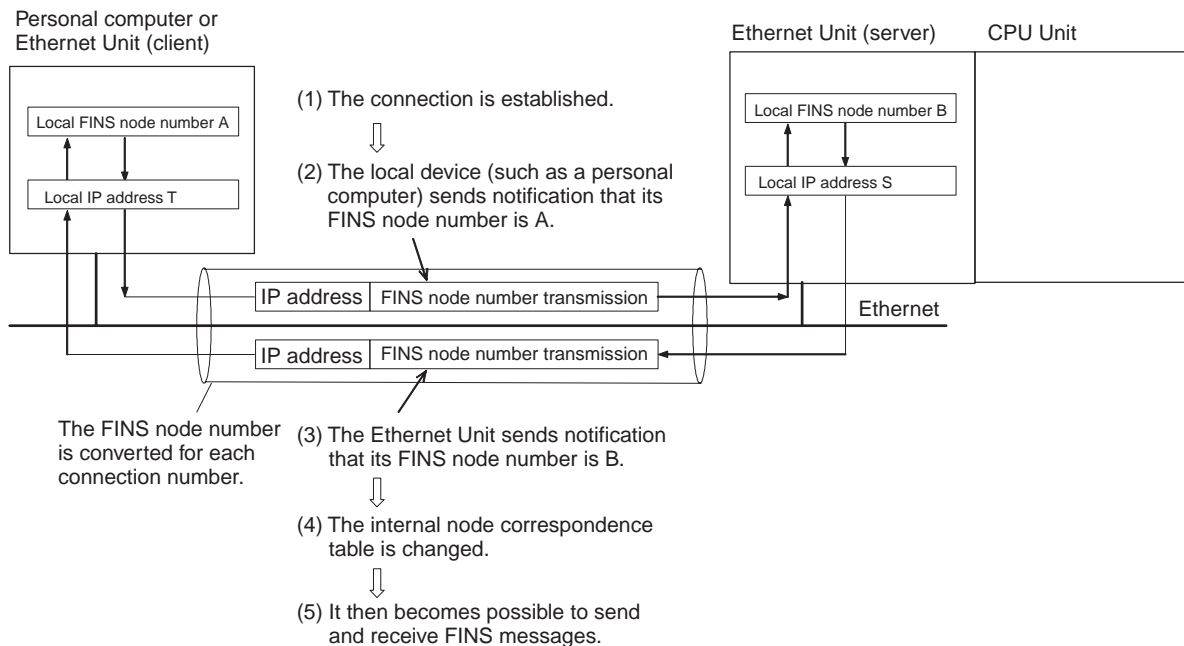

Setting FINS/TCP Connections

The procedure for setting FINS/TCP connections involves the items described below. The settings are made individually for each connection (numbers 1 to 16) under *FINS/TCP settings* in the Unit Setup.

Local Device Is Server

1,2,3...

1. Set the server.
2. Set IP addresses for connected devices.
If the option for protection by IP addresses is checked, set the IP addresses for clients where connections are permitted. (This can be omitted.)
3. Automatic FINS node address allocation:
If the client (generally a personal computer) supports FINS/TCP, and if it is to be used without setting a FINS node address, the value set here (from 239 to 254) can be allocated to the client.
Functions related to these settings are explained in detail in the *Operation Manual Construction of Applications, Creating Host FINS Communication Applications*. The default settings should normally be used.

Local Device Is a Client

1,2,3...

1. Set the client.
2. Set the IP addresses for the connection destination.
Set the IP address for the remote Ethernet Unit (i.e., the server) connected by FINS/TCP.
This setting must be made if this Ethernet Unit is to be used as a FINS/TCP client.

5-2-3 Application Examples

Responding to Computers with Changed IP Addresses

FINS/UDP Communications Method

With FINS/UDP, whether using the automatic conversion method (dynamic), the IP address table method, or the combined method, remote FINS node addresses and remote IP addresses in the internal table are changed after FINS messages are received. Therefore, even when a FINS command has been received from a personal computer (a DHCP client computer) for which the IP address is dynamically changed, a response can still be sent back to the computer (the DHCP client computer) from which the command originated.

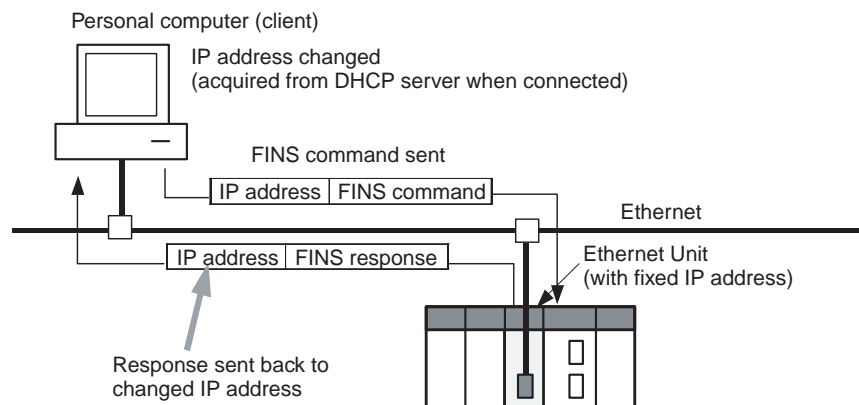

FINS/TCP Communications Method

With FINS/TCP, FINS node addresses and IP addresses in the internal table are changed with each connection that is established. Therefore, even when a FINS command has been received from a personal computer (a DHCP client computer) for which the IP address is dynamically changed, a response can still be sent back to the computer (the DHCP client computer) from which the command originated.

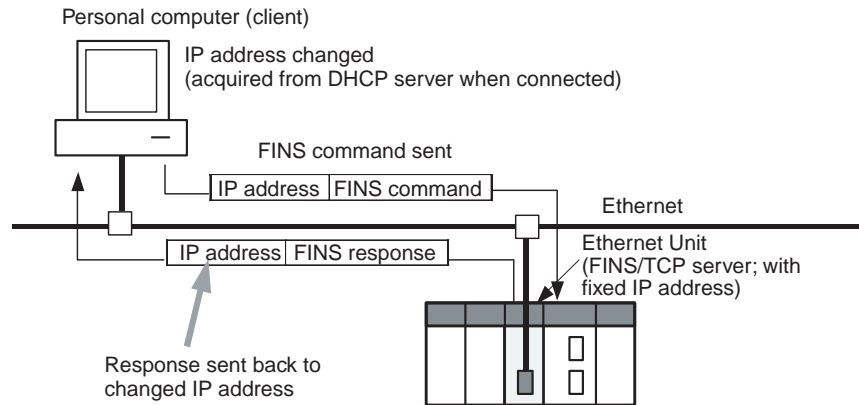

Note Automatic IP Address Setting by DHCP Service

DHCP service is a method whereby a DHCP server collectively manages all of the IP address in a network.

Nodes that are functioning as clients acquire IP addresses from the DHCP server whenever the system is started. Therefore, at a personal computer using the DHCP service, IP addresses may be different with each system startup.

DHCP service is mainly used for automatic settings in devices such as personal computers that are used for client applications. Nodes used for server applications, such as mail servers, are normally allocated fixed IP addresses. Ethernet Units in PLC systems are also allocated fixed IP addresses.

Simultaneously Running Multiple Applications on a Personal Computer

In communications involving previous models, multiple communications applications were configured on personal computers according to data accessing uses, and the fact that no more than one UDP port number for FINS communications could be used on any given computer created a problem. This Ethernet Unit provides a practical solution with an internal table that pairs remote nodes (applications) with FINS node addresses, enabling dynamic changes.

FINS/UDP Communications Method

FINS nodes are allocated individually for each application on the computer, and the respective FINS/UDP port numbers that are used are also allocated individually. When FINS/UDP FINS commands are sent from individual applications to the Ethernet Unit, the respective remote IP addresses and remote port numbers in the internal table are dynamically changed.

FINS/TCP Communications Method

With this method as well, FINS nodes are allocated individually for each application on the computer, and the respective FINS/TCP port numbers that are used are also allocated individually. Each application is positioned with a FINS/TCP client, and requests the opening of a connection with the Ethernet Unit's FINS/TCP server. When the connection is established, the respective remote IP address and remote port number in the internal table are dynamically changed.

5-2-4 Related Products and Communications/Setting Methods

Models Supporting Automatic Generation Method (Dynamic)

Product		Model/Series/ Version	Supports combined method?
CS1D Ethernet Unit	100Base-TX	CS1D-ETN21D	Yes
CS-series Ethernet Unit	100Base-TX	CS1W-ETN21	Yes
	10BASE-5	CS1W-ETN01	No: Set by automatic generation method or combined method. Com- munications are not pos- sible with personal computers with variable IP addresses.
	10Base-T	CS1W-ETN11	
CJ-series Ethernet Unit	100Base-TX	CJ1W-ETN21	Yes
	10Base-T	CJ1W-ETN11	No: Set by automatic generation method or combined method. Com- munications are not pos- sible with personal computers with variable IP addresses.
CV/CVM1-series Ethernet Unit	10BASE-5	CV500-ETN01	No: Set manually so that automatic settings can be used with the automatic generation method.
FinsGateway		Version 4.xx or earlier	No: Set manually so that automatic settings can be used with the automatic generation method.
		Version 2003 or higher	Yes
Programmable Terminal		NS Series	No: Set manually so that automatic settings can be used with the automatic generation method.
Open Network Controller (ONC)		---	No: Set manually so that automatic settings can be used with the automatic generation method.

Models Supporting Automatic Generation Method (Static)

Product		Model/Series/ Version	Supports combined method?
CS1D Ethernet Unit	100Base-TX	CS1D-ETN21D	Yes
CS-series Ethernet Unit	100Base-TX	CS1W-ETN21	Yes
	10BASE-5	CS1W-ETN01	Yes: Simply called "auto- matic generation method."
	10Base-T	CS1W-ETN11	
CJ-series Ethernet Unit	100Base-TX	CJ1W-ETN21	Yes
	10Base-T	CJ1W-ETN11	Yes: Simply called "auto- matic generation method."
CV/CVM1-series Ethernet Unit	10BASE-5	CV500-ETN01	Yes: Simply called "auto- matic generation method."
FinsGateway		Version 4.xx or earlier	No: Set manually so that automatic settings can be used with the automatic generation method.
		Version 2003 or higher	Yes
Programmable Terminal		NS Series	No: Set manually so that automatic settings can be used with the automatic generation method.
Open Network Controller (ONC)		---	No: Set manually so that automatic settings can be used with the automatic generation method.

Models Supporting IP Address Table Method

Product		Model/Series/Version	Supports combined method?
CS1D Ethernet Unit	100Base-TX	CS1D-ETN21D	Yes
CS-series Ethernet Unit	100Base-TX	CS1W-ETN21	
	10BASE-5	CS1W-ETN01	
	10Base-T	CS1W-ETN11	
CJ-series Ethernet Unit	100Base-TX	CJ1W-ETN21	
	10Base-T	CJ1W-ETN11	
CV/CVM1-series Ethernet Unit	10BASE-5	CV500-ETN01	
FinsGateway		Version 4.xx or earlier	No: Set manually. FINS communications are not possible with personal computers set automatically by DHCP.
		Version 2003 or higher	
Programmable Terminal		NS Series	No: Set manually. FINS communications are not possible with personal computers set automatically by DHCP.
Open Network Controller (ONC)		---	

Models that Can Use the Combined Method

Product		Model/Series/Version	Supports combined method?
CS1D Ethernet Unit	100Base-TX	CS1D-ETN21D	Yes
CS-series Ethernet Unit	100Base-TX	CS1W-ETN21	Yes
	10BASE-5	CS1W-ETN01	No
	10Base-T	CS1W-ETN11	No
CJ-series Ethernet Unit	100Base-TX	CJ1W-ETN21	Yes
	10Base-T	CJ1W-ETN11	No
CV/CVM1-series Ethernet Unit	10BASE-5	CV500-ETN01	No
FinsGateway		Version 4.xx or earlier	No
		Version 2003 or higher	Yes
Programmable Terminal		NS Series	No: Set manually. FINS communications are not possible with personal computers set automatically by DHCP.
Open Network Controller (ONC)		---	

5-2-5 Pairing IP Addresses and FINS Node Addresses

The following table shows the methods for pairing IP address and FINS node addresses, and the relation between fixed and variable address, for both FINS/UDP and FINS/TCP.

Communications method	Method of pairing of IP addresses and FINS node addresses	IP address determination		Client (personal computer or PLC)		Server (PLC)	
				FINS node address	IP address	FINS node address	IP address
FINS/UDP	By pairing FINS node addresses with IP addresses in Ethernet	IP address conversion	Automatic generation method (static)	Fixed	Fixed	Fixed	Fixed
			Automatic generation method (dynamic)	Fixed	Fixed or variable	Fixed	Fixed
			IP address table method	Fixed	Fixed or variable	Fixed	Fixed
			Combined method	Fixed	Fixed or variable	Fixed	Fixed
FINS/TCP	By automatic conversion of FINS node addresses at Ethernet Unit and remote node (and then sending and receiving data)	Automatic	Connection method (automatic FINS node address conversion)	Fixed or can be allocated automatically when not determined.	Fixed or variable	Fixed	Fixed

5-3 Private and Global Addresses

5-3-1 Private and Global Addresses

There are two kinds of IP addresses, private and global.

- Global addresses: These are IP addresses that connect directly to the Internet. Allocated by application to NIC, each address is unique in the world, and as many as 4.3 million can be allocated worldwide.
- Private addresses: These are IP addresses for Intranet (LAN) use, and cannot connect directly to the Internet. Frames that include private IP addresses are restricted by the router from being sent outside the LAN.

Generally, as shown below, global addresses in the intranet are allocated only to IP routers (such as broadband routers) interfacing with the Internet. All other nodes in the intranet, including the Ethernet Unit, are allocated private addresses.

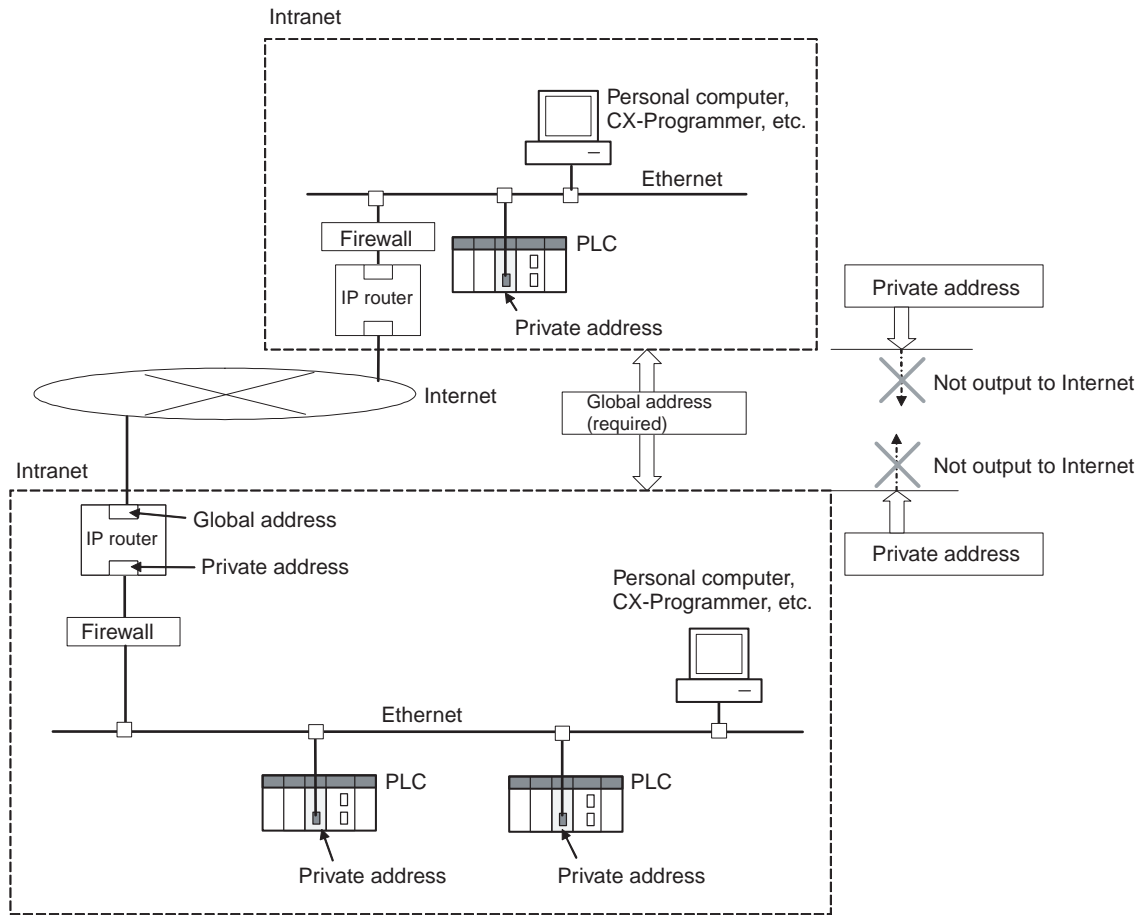

Communications Services That Require Global Addresses for Ethernet Units

A global address is required for the Ethernet Unit's IP address when the following communications services are used over the Internet.

- FINS communications services
- File transfers
- Socket services

When mail is sent or received over the Internet, the Unit's IP address can be a private address.

5-3-2 Using a Private Address for the Ethernet Unit

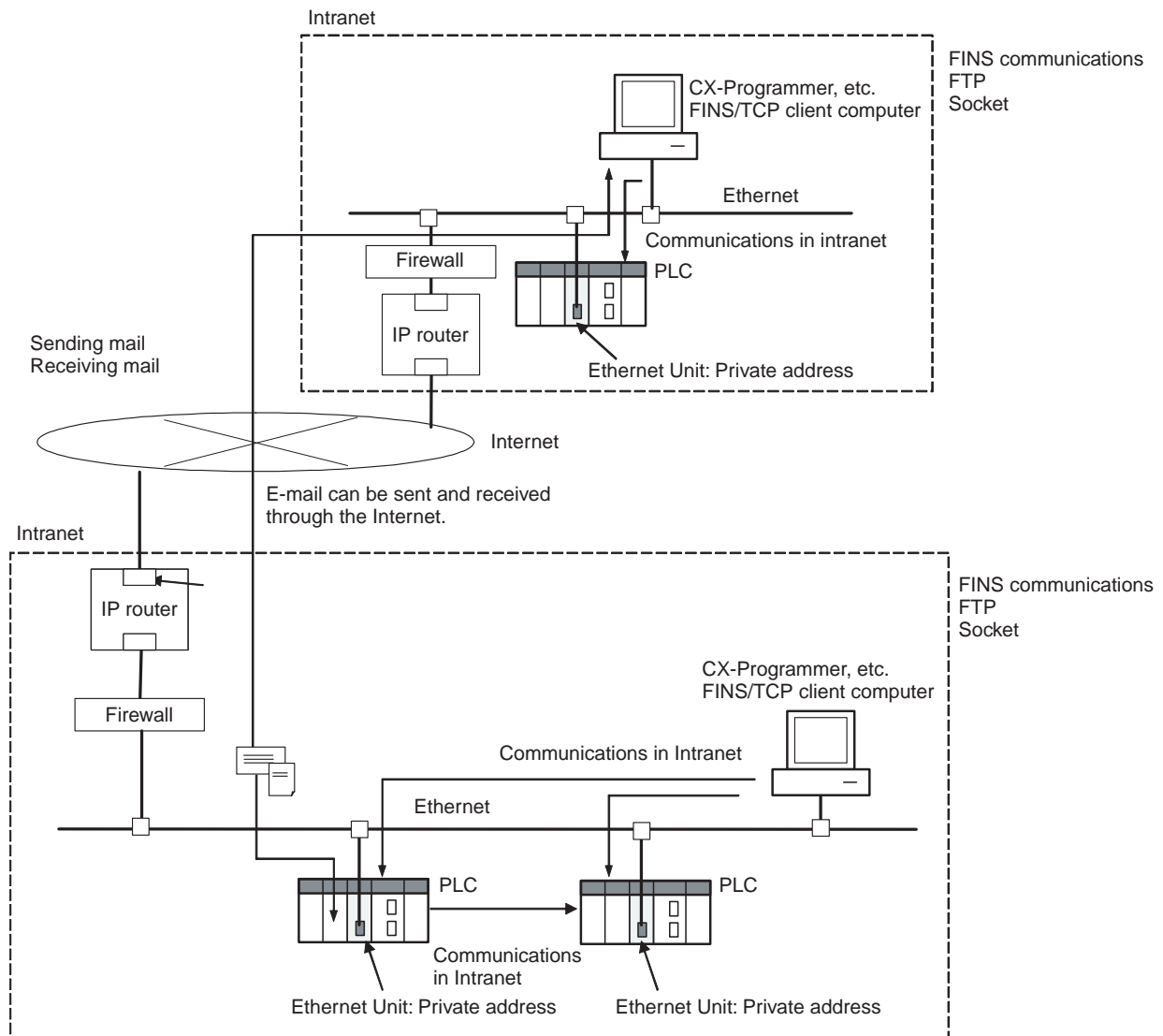

Conditions for Using Communications Applications

When the Ethernet Unit has a private address, communications applications can be used under the following conditions:

FINS Communications Service

- FINS communications service is enabled only between Ethernet Units with private addresses on the intranet.
A device such as a personal computer (with a FINS application including a CX-Programmer) cannot connect online and communicate over the Internet with an Ethernet Unit that has a private address. FINS communications over the Internet are also not possible between Ethernet Units with private addresses.
- Either FINS/TCP or FINS/UDP can be used for the FINS communications service.
- With FINS/UDP, all of the Ethernet Unit IP address conversion methods can be used.

- With FINS/UDP, when the IP address (private address) of a computer serving as a DHCP client is changed, the Ethernet Unit's IP address conversion method will be the automatic generation method (dynamic), the combined method, or the IP address table method. When FINS/TCP is used, IP addresses can be changed automatically.

Note Network Security and Firewalls

Setting up an intranet through a global address involves network security considerations. Before doing so, be sure to consult with a network specialist and consider installing a firewall.

Once a firewall has been set up by a communications company, on the other hand, there may be some applications that cannot be used. Be sure to check first with the communications company.

5-3-3 Ethernet Unit with a Global Address

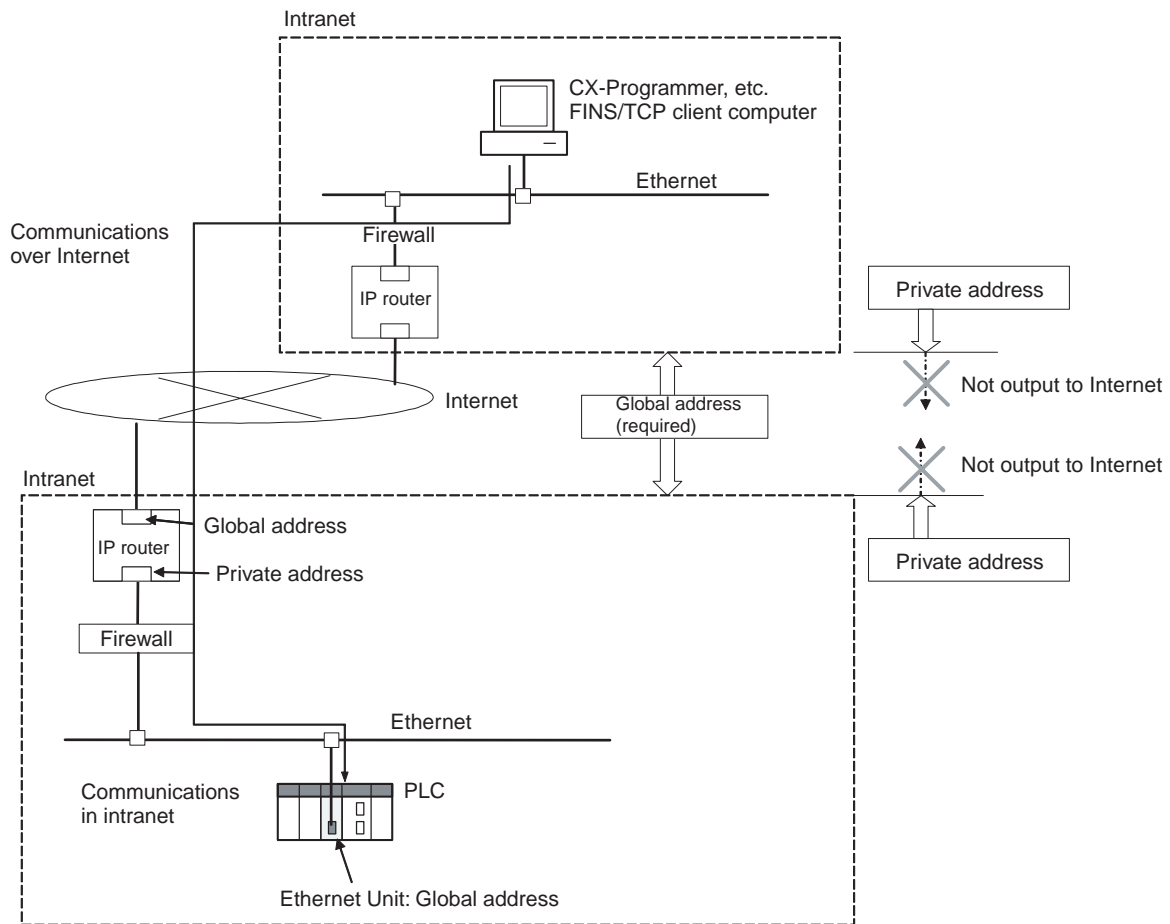

Conditions for Using Communications Applications

Communications applications can be used over the Internet under the following conditions:

FINS Communications Service

- A device such as a personal computer (with a FINS application including a CX-Programmer) can connect online and communicate over the Internet with an Ethernet Unit that has a global address.

- FINS/TCP is recommended as the FINS communications service method.
FINS/TCP is more reliable than FINS/UDP in terms of communications errors involving IP routers.
- The IP address table method is used as the Ethernet Unit's IP address conversion method.
- The TCP port number to be used for FINS/TCP cannot be used if prohibited by a firewall in the communications path.

Note **Network Security and Firewalls**

Setting a global IP address for an Ethernet Unit involves network security considerations. It is recommended that the user contract with a communications company for a dedicated line, rather than using a general line such as a blue band. Also, be sure to consult with a network specialist and consider security measures such as a firewall.

Once a firewall has been set up by a communications company, on the other hand, there may be some applications that cannot be used. Be sure to check first with the communications company.

SECTION 6

FINS Communications

This section provides information on communicating on Ethernet Systems and interconnected networks using FINS commands. The information provided in the section deals only with FINS communications in reference to Ethernet Units.

FINS commands issued from a PLC are sent via the SEND(090), RECV(098), and CMND(490) instructions programmed into the user ladder-diagram program. Although an outline of these instructions is provided in this section, refer to the *CS/CJ-series Programmable Controllers Programming Manual (W340)* for further details on programming these instructions.

6-1	Overview of FINS Communications	90
6-1-1	Communications On an Ethernet Network	90
6-1-2	Using the FINS/UDP and FINS/TCP Methods	91
6-1-3	FINS Communications Service Specifications for Ethernet	91
6-2	FINS/UDP Method	92
6-2-1	Overview	92
6-3	FINS/TCP Method	94
6-3-1	Overview	94
6-4	Creating Routing Tables	98
6-4-1	Routing Table Overview	98
6-4-2	Connecting and Using a Peripheral Device for the PLC	99
6-4-3	Routing Table Setting Examples	100
6-5	Using FINS Applications	102
6-5-1	CX-Programmer (CX-Server)	102
6-5-2	FinsGateway	107
6-6	Communicating between OMRON PLCs	113
6-6-1	Communications Specifications	113
6-6-2	PLC Communications Data Areas	114
6-6-3	Using SEND(090), RECV(098), and CMND(490)	115
6-6-4	Writing Programs	119
6-6-5	Program Example	123
6-6-6	Transmission Delays (Ignoring Network Delays)	125
6-7	Network Status Performance	129
6-8	Precautions on High Traffic in FINS Communications	130

6-1 Overview of FINS Communications

6-1-1 Communications On an Ethernet Network

Data is sent and received as UDP/IP packets or TCP/IP packets on an Ethernet network.

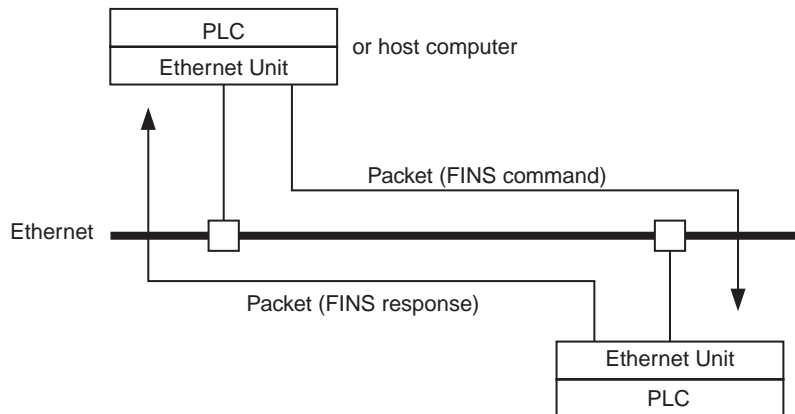

In the FINS communications service, both an IP address for IP (the Internet layer) and a FINS node address for FINS (the application layer) are used for the remote device. Also, 9600 is used as the default setting for the local UDP or TCP port number (i.e., the transport layer) for identifying the application layer, i.e., the FINS communications service. (Another number can be set for the FINS/UDP port from the Setup Tab in the Unit Setup.)

For details on pairing FINS node addresses with IP addresses and UDP/TCP port numbers, refer to *5-2 IP Addresses in FINS Communications*.

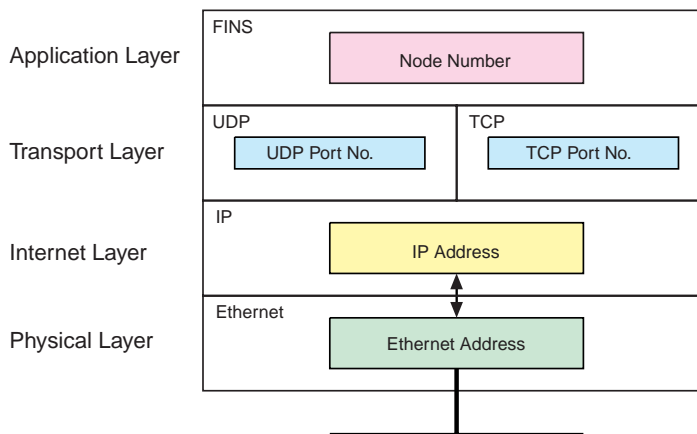

The FINS communications service is a communications method based on UDP/IP, and it is supported by most OMRON Ethernet-related products. (In this manual it is called the FINS/UDP method.) In addition to supporting the FINS/UDP method, the CS1D-ETN21D, CS1W-ETN21 and CJ1W-ETN21 support FINS communications using TCP/IP. (In this manual, this is called the FINS/TCP method.)

6-1-2 Using the FINS/UDP and FINS/TCP Methods

It is recommended that FINS/UDP and FINS/TCP be used as follows:

- When using a duplex Ethernet network:
Use the FINS/UDP method for Duplex Ethernet Units.
- When remote devices do not support the FINS/TCP method:
Use the FINS/UDP method for FINS communications with those devices.
- When FINS nodes are connected on the same Ethernet segment:
Use the FINS/UDP method between those nodes.
Note FINS/UDP offers a slight advantage in performance.
- When FINS nodes are connected over multiple IP network layers:
Use the FINS/TCP method between those nodes.
Note FINS/TCP offers superior communications quality.
- When the quality of connections is unreliable, as with wireless LAN:
Use the FINS/TCP method between those nodes.
Note FINS/TCP offers superior communications quality.

6-1-3 FINS Communications Service Specifications for Ethernet

Item	Specifications	
Number of nodes	254	
Message length	2,012 bytes max.	
Number of buffers	192	
Protocol name	FINS/UDP method	FINS/TCP method
Protocol used	UDP/IP	TCP/IP
	The selection of UDP/IP or TCP/IP is made by means of the FINS/TCP Tab in the CX-Programmer's Unit Setup.	
Number of connections	---	16
Port number	9600 (default) Can be changed.	9600 (default) Can be changed.
Protection	No	Yes (Specification of client IP addresses when Unit is used as a server)
Other	Items set for each UDP port • Broadcast • IP address conversion	Items set for each connection • Server/client specification • Remote IP address specification When client: Specify remote Ethernet Unit (server) IP address. When server: Specify IP addresses of clients permitted to connect. • Automatic FINS node address allocation: Specify automatic allocation of client FINS node addresses. • Keep-alive: Specify whether remote node keep-alive is to be used. TCP/IP Setting • Remote node keep-alive time
Internal table	This is a table of correspondences for remote FINS node addresses, remote IP addresses, TCP/UDP, and remote port numbers. It is created automatically when power is turned ON to the PLC or when the Ethernet Unit is restarted, and it is automatically changed when a connection is established by means of the FINS/TCP method or when a FINS command received. The following functions are enabled by using this table. • IP address conversion using the FINS/UDP method • Automatic FINS node address conversion after a connection is established using the FINS/TCP method • Automatic client FINS node address allocation using the FINS/TCP method • Simultaneous connection of multiple FINS applications	

6-2 FINS/UDP Method

6-2-1 Overview

FINS/UDP Features

The FINS/UDP method is a FINS communications method that uses the UDP/IP protocol. UDP/IP is a connectionless communications protocol. When a message is sent from one node to another, the two nodes have an equal relationship and there is no clear connection. If using TCP is like making a telephone call, then UDP is more like delivering a memo by hand. Although the UDP protocol is fast, data communications are less reliable than with TCP.

In particular, when sending large amounts of data involving significant routing, the user must program measures, such as retries, into applications in order to improve reliability.

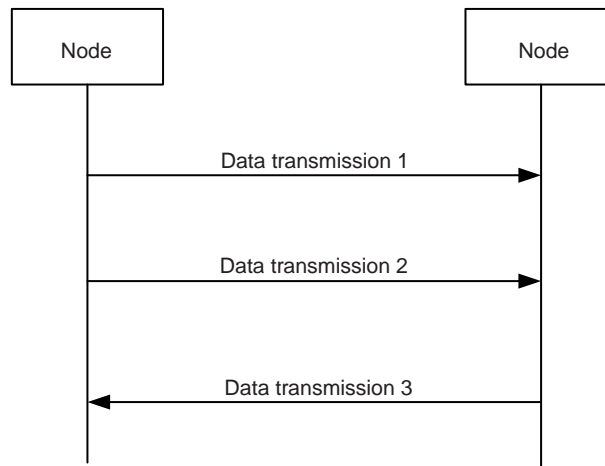

Data is sent in one direction, with no confirmation of whether the data was received. Because there are few procedures involved, data can be sent at high speed but with less reliability than with TCP.

The FINS/UDP method has the following features:

- Because FINS/UDP is a connectionless protocol, there is no limit to the number of corrections.
- FINS/UDP can be used for broadcasting.
- When data is sent via an IP network with multiple layers (such as the Internet), communications reliability drops.

FINS/UDP Frame Format

The following diagram shows the structure of a UDP packet used for sending and receiving data on an Ethernet network.

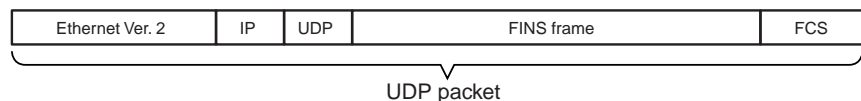

As the diagram shows, a nested structure is used with the FINS/UDP method, i.e., Ethernet Ver. 2, IP frame, UDP frame, and FINS frame. A UDP data section (FINS frame) that exceeds 1,472 bytes is split into packets for transmission. The split UDP data is then joined automatically at the UDP/IP protocol layer. There is normally no need to pay attention at the application layer to this split, but it may not be possible to send 1,472-byte UDP packets over an IP network with multiple layers. When using the FINS communications service in a system such as this, select the FINS/TCP method.

UDP Port Numbers for FINS/UDP

The UDP port number is the number for UDP to identify the application layer (i.e., the FINS communications service in this case). When communications are executed by UDP/IP, this port number must be allocated to the communications service.

The default setting for the FINS/UDP local UDP port number (i.e., the Ethernet Unit's UDP port number) is 9600. To set another number, make the setting for the FINS/UDP port using the Setup Tab in the Unit Setup.

At the Ethernet Unit, a UDP/IP frame received with a FINS/UDP port number is recognized as a FINS frame.

Procedure for Using FINS/UDP

1. Make the basic settings.
Refer to *SECTION 2 Startup Procedure* in the *Operation Manual Construction of Networks*.

↓

2. Make the settings in the Unit Setup.
With the CX-Programmer connected online, select the Ethernet Unit in the CX-Programmer's I/O Table Window. Right-click, and select Unit Setup. Then make the following settings in the Unit Setup Window.
Setup Tab

- Broadcast
- FINS/UDP port (Default: 9600)
- IP address table (for the IP address table method only)

↓

3. Make the routing table settings and transfer them to each PLC. (See note.)
Set the routing tables with CX-Net, and transfer it to each PLC.

↓

4. Create a ladder program that includes the SEND(090), RECV(098), and CMND(490) instructions.

Note Routing tables are required in the following situations:

- When communicating with a PLC or computer on another network (e.g., remote programming or monitoring using FINS messages or a CX-Programmer).
- When multiple Communications Units are mounted to a single PLC (i.e., CPU Unit).
- When routing tables are used for one or more other nodes on the same network.

It is not necessary to set routing tables if one Communications Unit is mounted to the PLC and the nodes are connected as one network.

6-3 FINS/TCP Method

6-3-1 Overview

FINS/TCP Features

The FINS/TCP method is a FINS communications method that uses the TCP/IP protocol. TCP/IP is a connection-type communications protocol. Before a message is sent from one node to another, it is necessary to establish a virtual circuit, i.e., a connection. Once a connection has been established, communications are quite reliable. The arrival of data that is sent via the connection is confirmed by an acknowledgement (ACK) response, and retries are executed automatically as required.

The FINS/TCP method has been newly added to the CS1W-ETN21 and CJ1W-ETN21 Ethernet Units.

Note Do not use FINS/TCP to communicate with nodes that switch automatically when using a duplex Ethernet network. Otherwise the memory may be unexpectedly overwritten with old data. This occurs because the recovery function at the TCP/IP layer will resend previous communications frames from the Primary Unit to the network after a communications failure and recovery of the Primary Unit.

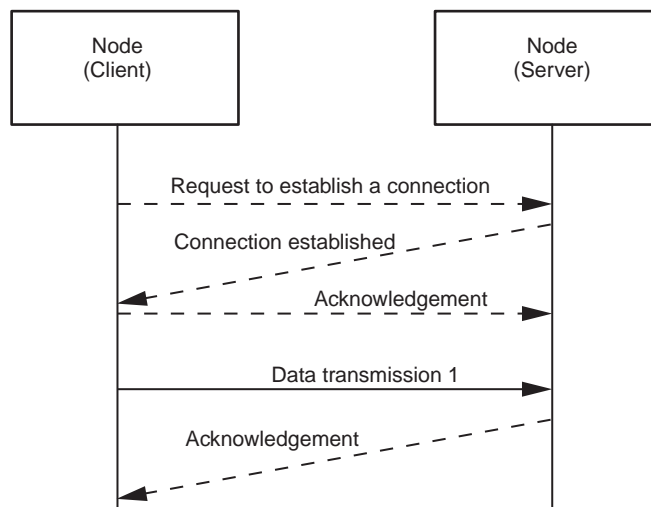

An acknowledgement is received whenever a connection is established or data is sent, so transmissions are more reliable but somewhat slower.

Compared to the FINS/UDP method, the FINS/TCP method has the following characteristics.

- Data transmission is more reliable, due to factors such as retry processing at the TCP/IP layer. The FINS/TCP method is thus better suited to dealing with communications errors in an IP network that spans several layers.
- Remote clients can be restricted by means of settings at the server (i.e., the server can be protected from access by non-specified IP addresses).
- Broadcasting cannot be used.
- TCP/IP has various retry procedures, and this tends to lower its performance in comparison with UDP/IP.

- There is a limit to the number of connections that can be made (i.e., 16 connections maximum), and any given node can communicate only with up to 16 other nodes at a time.
- Once a FINS/TCP connection (connection number, remote IP address) has been set in the Unit Setup, it can be dynamically changed from the ladder program using a FINS command (i.e., FINS/TCP CONNECTION REMOTE NODE CHANGE REQUEST).

FINS/TCP Frame Format

The following diagram shows the structure of a TCP packet sent over an Ethernet network.

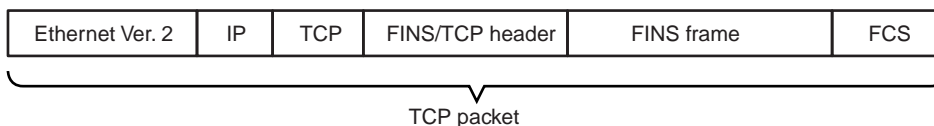

As the diagram shows, a nested structure is used with the FINS/TCP method, i.e., Ethernet Ver. 2, IP frame, TCP frame, FINS/TCP header frame, and FINS frame. A TCP data section (FINS/TCP header + FINS frame) that exceeds the segment size (default: 1,024 bytes, with automatic adjustment for optimum values between the nodes) is split into TCP packets for transmission. The split TCP data is then joined automatically at the remote node's TCP/IP protocol layer. The TCP/IP protocol layer, however, cannot determine where the data has been split, so the TCP data sections from multiple packets are all joined together. Therefore, when using the FINS/TCP method, FINS/TCP headers must be added at the beginning of FINS frames in order to serve as FINS frame delimiters. The length of the data in the following FINS frame is stored in the header, allowing the frame to be separated out by the remote node. With the Ethernet Unit and FinsGateway Ver. 2003 the appropriate frames are separated out automatically, so there is normally no need to be pay attention to it at the application layer.

TCP Port Number for FINS/TCP

The TCP port number is the number for TCP to identify the application layer (i.e., the FINS communications service in this case). When communications are executed using TCP/IP, this port number must be allocated for the communications service.

The default setting for the FINS/TCP local TCP port number (i.e., the Ethernet Unit's TCP port number) is 9600. To set another number, make the setting for the FINS/TCP port using the Setup Tab in the Unit Setup.

The FINS/TCP port number set in the Unit Setup is used by the FINS/TCP server's TCP socket. The FINS/TCP client's TCP socket uses any TCP port number that can be used at that node. (With the Ethernet Unit and FinsGateway Ver. 2003, an unused TCP port is automatically detected and utilized.)

At the Ethernet Unit, a TCP/IP frame that is received is recognized as a FINS frame, according to the remote TCP port number in the frame.

FINS/TCP Connection Numbers

FINS/TCP allows up to 16 FINS/TCP connections to be established simultaneously, and these 16 connections are managed at the Ethernet Unit by connection numbers. When setting connections by means of the FINS/TCP settings in the CX-Programmer's Unit Setup, set them individually using these connection numbers.

FINS/TCP Connection Status (Word n+24)

While a connection with a remote node is established, the bit corresponding to the FINS/TCP connection status turns ON in the section of the CPU Bus Unit words allocated in the CIO Area. The bit turns OFF if the connection is terminated by a communications error or a FINS command (i.e., FINS/TCP CONNECTION REMOTE NODE CHANGE REQUEST).

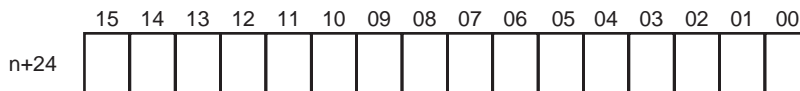

*: Bit 15 corresponds to connection No. 16, bit 00 to connection No. 1, etc.

FINS/TCP Communications Procedure

With FINS/TCP, FINS node addresses are exchanged immediately after a connection is established. This makes it possible to determine the FINS node addresses to which the 16 connection numbers, and to manage them in an internal table.

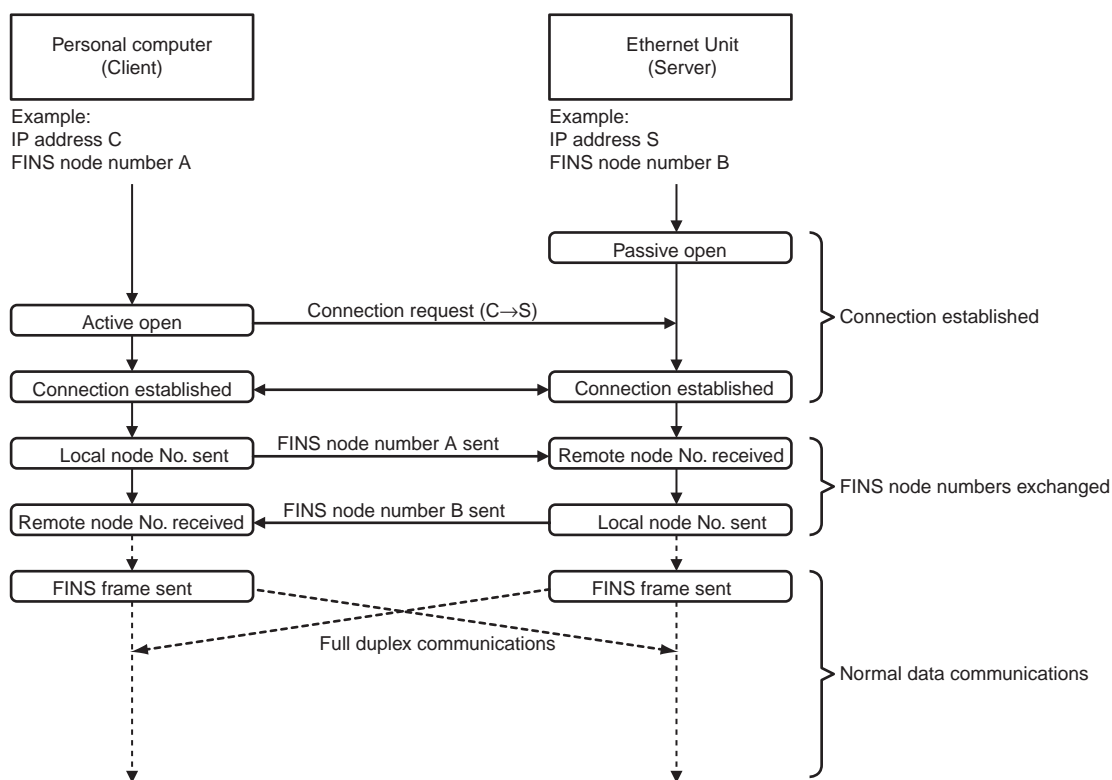

After a connection has been established as a FINS/TCP server, it is terminated in the following ways.

- When the connection is closed by the client.
- When a FINS command to close the connection (FINS/TCP CONNECTION REMOTE NODE CHANGE REQUEST) is sent by the client.
- When there is no response from the client when the keep-alive function is in effect.

After a connection has been established as a FINS/TCP client, it can be terminated in the following ways.

- If the connection is closed by the server.
- If there is no response from the client when the keep-alive function is in effect.

Even if the connection is closed at the FINS/TCP client, requests continue to be made to the FINS/TCP server every few seconds to open a connection.

Note After the Ethernet Unit is powered up or restarted, the IP address for the connection used as the FINS/TCP client is the remote IP address set under the FINS/TCP Tab in the Unit Setup.

To dynamically change the remote IP address (i.e., during CPU Unit operation), execute the CMND(490) instruction in the ladder program and send a FINS command (FINS/TCP CONNECTION REMOTE NODE CHANGE REQUEST; command code: 27 30 hexadecimal) to the Ethernet Unit.

Procedure for Using FINS/TCP

1. Make the basic settings.

Refer to *Section 2 Startup Procedure* in the *Operation Manual Construction of Networks*.



2. Make the settings in the Unit Setup.

With the CX-Programmer connected online, select the Ethernet Unit in the CX-Programmer's I/O Table Window. Right-click, and select Unit Setup. Then make the following settings in the Unit Setup Window.

Setup Tab

- FINS/TCP port (Default: 9600)

FINS/TCP Tab

- Remote IP addresses (when client)

Note: When functioning as a server, set the permitted client IP addresses only when protection is in effect.

- Automatically allocated FINS node addresses

Note: The functions of these items are described in detail in the *Operation Manual Construction of Applications, FINS Communications Service*. Normally the defaults should be used.

- Keep-alive setting

Note: Normally this should be selected to be used.

- IP addresses protection setting

Note: Check this only for protection as the server.



3. Make the routing table settings and transfer them to each PLC. (See note.) Set the routing tables with CX-Net, and transfer it to each PLC.



4. Create a ladder program that includes the SEND(090), RECV(098), and CMND(490) instructions.

Note Routing tables are required in the following situations:

- When communicating with a PLC or computer on another network (e.g., remote programming or monitoring using FINS messages or a CX-Programmer)
- When multiple Communications Units are mounted to a single PLC (i.e., CPU Unit)
- When routing tables are used for one or more other nodes on the same network

It is not necessary to set routing tables if one Communications Unit is mounted to the PLC and the nodes are connected as one network.

6-4 Creating Routing Tables

When the FINS communications service is used, routing tables must be created in advance.

Routing tables are required in the following cases.

- When using a duplex Ethernet network
- When communicating with a PLC or personal computer on another network (e.g., remote programming or monitoring using FINS messages or a CX-Programmer using a non-duplex Ethernet network.
- When more than one Communications Unit is mounted to a single PLC (i.e., CPU Unit) using a non-duplex Ethernet network.
- When routing tables are used for one or more other nodes on the same network using a non-duplex Ethernet network.

Routing tables are not required in the following case.

- When one Communications Unit is mounted to the PLC and all nodes are connected as one network.

The routing tables are required not only for nodes communicating via the FINS communications service but also for all relay nodes on the network.

6-4-1 Routing Table Overview

The routing tables describe the transmission path for FINS messages when the FINS communications are used. It consists of two tables: A local network table and a relay network table.

Local Network Table

The local network table is a table describing the correspondences among unit numbers of the Communications Units and Boards mounted to each node.

Set different network addresses for the primary and secondary networks. When setting the Secondary Unit in the local network table, set a unit number that is one number higher than the number set the rotary switches on the Unit plus one. For the Primary Unit, set the unit number that is set the rotary switches.

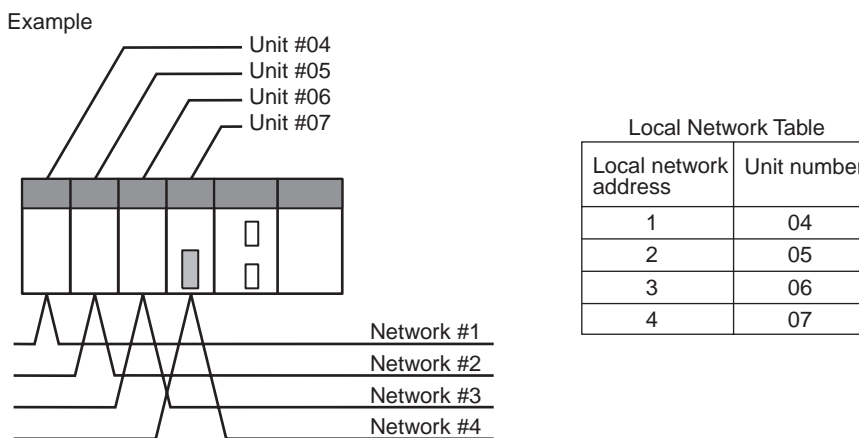

- Note**
1. The unit number is set (0 to F: 1 to 15) by the rotary switch on the front of the Ethernet Unit.
 2. The network address is the number of the network (1 to 127) to which the Communications Unit or Board is connected. It is set when the local network table is created.

Relay Network Table

A relay table is a table that shows the nodes to which data should be sent first in order to send data to a network that is not connected to the local node. It shows the correspondence between the address of the final destination network, and the network address and node address of the first relay point of the path to reach there. When internetwork communications are carried out, the end network can be reached by following the relay points.

Use only the primary network address for the destination network address and the relay network address setting for a duplex network. Do not use the secondary network in the relay network table.

The following example shows routing tables for sending data from PLC #1 (the local node: network address 1, node address 1) to PLC #4 (the destination node: network address 3, node address 2).

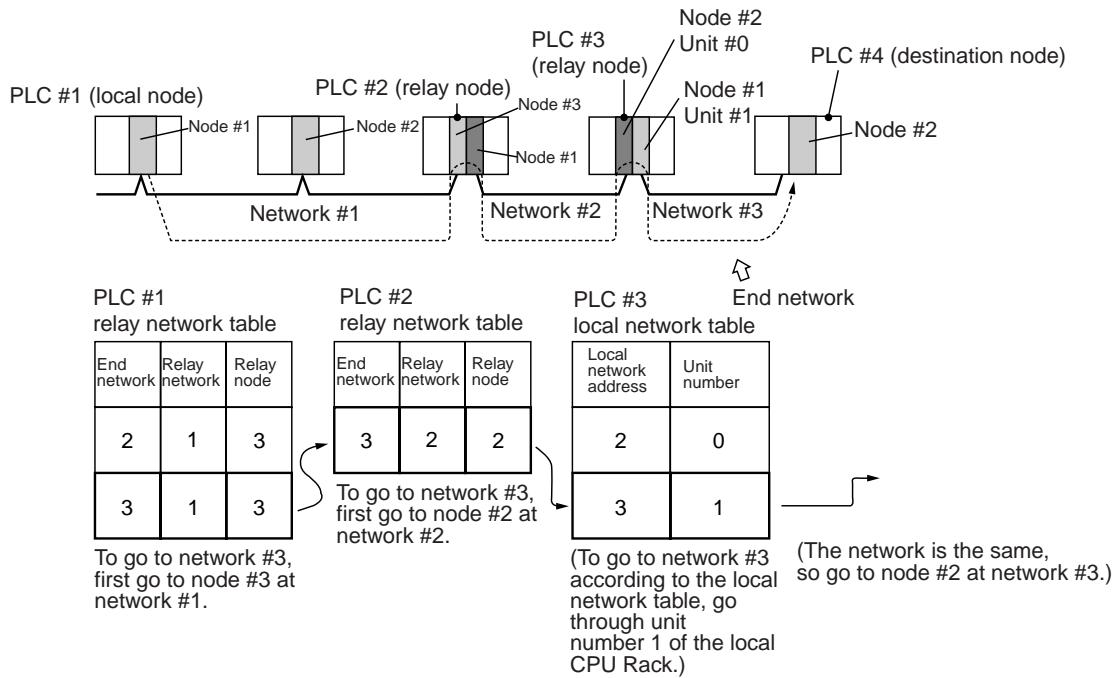

6-4-2 Connecting and Using a Peripheral Device for the PLC

Routing tables must be created by a CX-Net connected to the PLC. (They cannot be created using a Programming Console.) For details on how to connect and use the CX-Net, refer to the *CX-Programmer Ver.3.0 Operation Manual (W414)*. (CX-Net is automatically installed when CX-Programmer is installed.)

- Note**
1. When routing tables are transferred from the CX-Net to the PLC, the CPU Bus Unit is reset so that the routing tables that have been created can be read and enabled. Before transferring the routing tables, make sure that the devices in the system will not be adversely affected by resetting the CPU Bus Unit.
 2. To transfer routing tables for multiple nodes to a PLC in one batch, connect the CX-Net to a PLC with only one Communications Unit mounted. Routing tables cannot be transferred to other nodes from a PLC with multiple Communications Units mounted.
 3. Routing tables can only be transferred as a batch to multiple nodes within the same network as the PLC to which the CX-Net is connected.

6-4-3 Routing Table Setting Examples

■ **Example 1: Local Network Table for a PLC With Multiple Communication Units Mounted**

This example shows the local network table settings for a PLC to which multiple Communication Units (CPU Bus Units) are mounted.

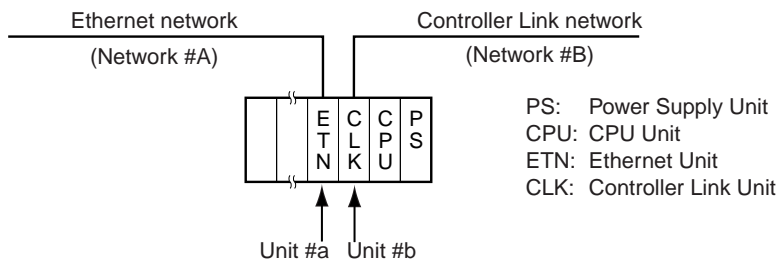

Local Network Table

No.	Local network	CPU Bus Unit
1	A	a
2	B	b

■ **Example 2: Three Interconnected Networks**

This example shows the relay network table settings for three different interconnected networks.

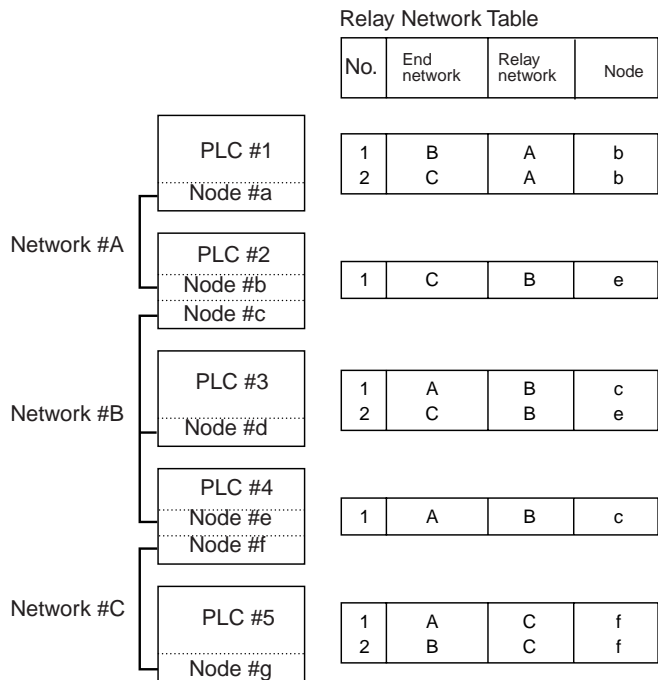

In the table for PLC #3, for example, if network #A is taken as the end network, then network #B becomes the relay network and node #c becomes the relay node. If network #C is taken as the end network, then network #B still becomes the relay network and node #e becomes the relay node.

■ Example 3: All Nodes

This example uses the following configuration to show the routing tables for all nodes.

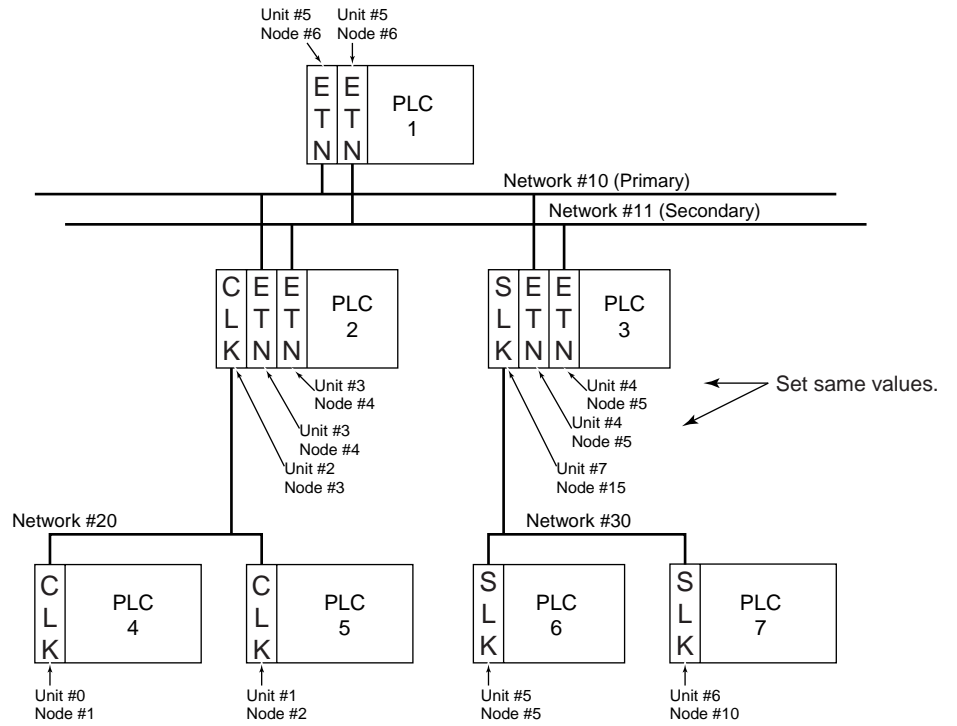

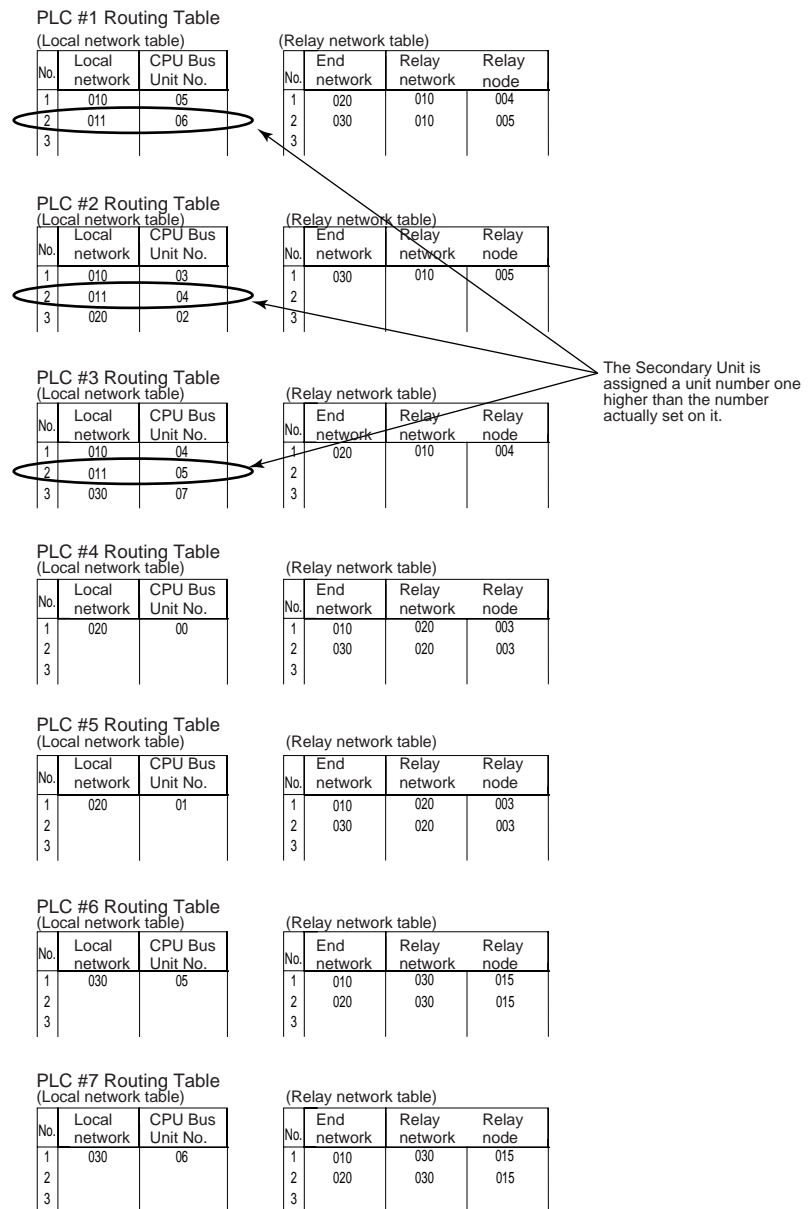

6-5 Using FINS Applications

6-5-1 CX-Programmer (CX-Server)

The following examples show how to connect online from a CX-Programmer on an Ethernet network to a PLC on the Ethernet network.

- Note**
- (1) The connection between the CX-Programmer and the PLC will not be redundant (i.e., will not switch automatically if an error occurs) if Ethernet is selected as the network type from the CX-Programmer.
 - (2) To create a redundant connection, select FinsGateway as the network type and install FinsGateway version 2003 or higher along with a duplex-compatible driver (ETN_UNIT) on the personal computer. Refer to 6.5.2 *FinsGateway*.

■ System Configuration Example 1: Within a Single Network

The following conditions must be met to connect online from a CX-Programmer/CX-Net on the primary network of the duplex Ethernet network to a PLC (PLC 1 below) on the duplex Ethernet network.

Conditions:

- Protocol: FINS/UDP
- IP address conversion: Automatic generation method (dynamic)

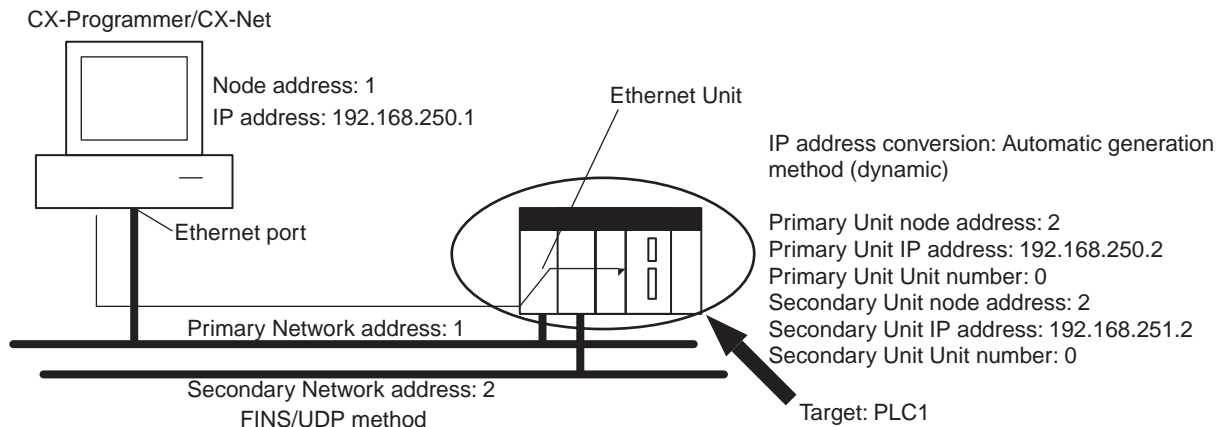

CX-Programmer's Change PLC Dialog Box

Settings for target PLC (PLC1)'s Change PLC Dialog Box			Setting
PLC name			PLC1
Network classification			Ethernet
Network Tab	FINS transmission source address		0
	FINS destination	Network number	0
		Node address	2
	Frame length		2,000 bytes
	Response monitor time		2 seconds
Driver Tab	Workstation node address		1
	Automatic generation method		Not selected
	IP address		192.168.250.2 (Primary Unit IP address)
	Port number		9600

CX-Programmer's Unit Setup

Setup Tab

Item	Setting
Broadcast	All ones (4.3BSD)
FINS/UDP port	Default (9600)
IP address	0.0.0.0 (Use default IP address.)
Subnet mask	0.0.0.0
IP address conversion	Automatic generation method (dynamic)
Baud rate	Automatic detection
IP router table	None

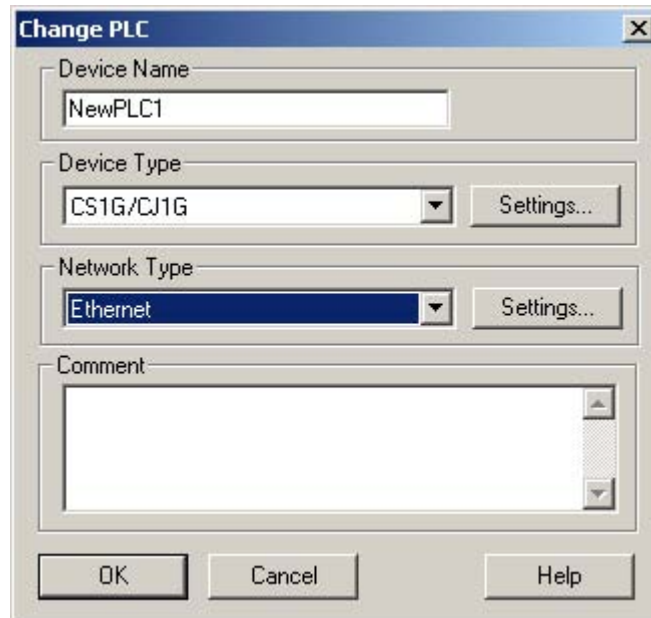
Example: Inputs to the CX-Programmer's Setup Window**Example: Change PLC Settings**

The "Change PLC" dialog box is shown with the following settings:

- Device Name: NewPLC1
- Device Type: CS1G/CJ1G
- Network Type: Ethernet
- Comment: (empty text area)

Buttons: OK, Cancel, Help

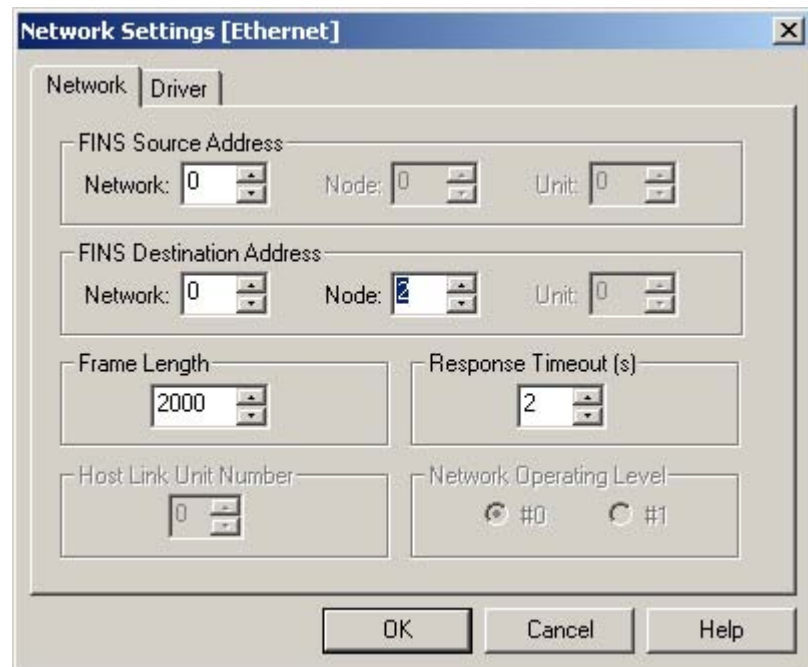
Example: Network Settings (Network Tab)

The "Network Settings [Ethernet]" dialog box is shown with the following settings:

- Network: 0
- Node: 0
- Unit: 0
- FINS Destination Address: Network: 0, Node: 2, Unit: 0
- Frame Length: 2000
- Response Timeout (s): 2
- Host Link Unit Number: 0
- Network Operating Level: #0 (selected)

Buttons: OK, Cancel, Help

Example: Network Settings (Driver Tab)

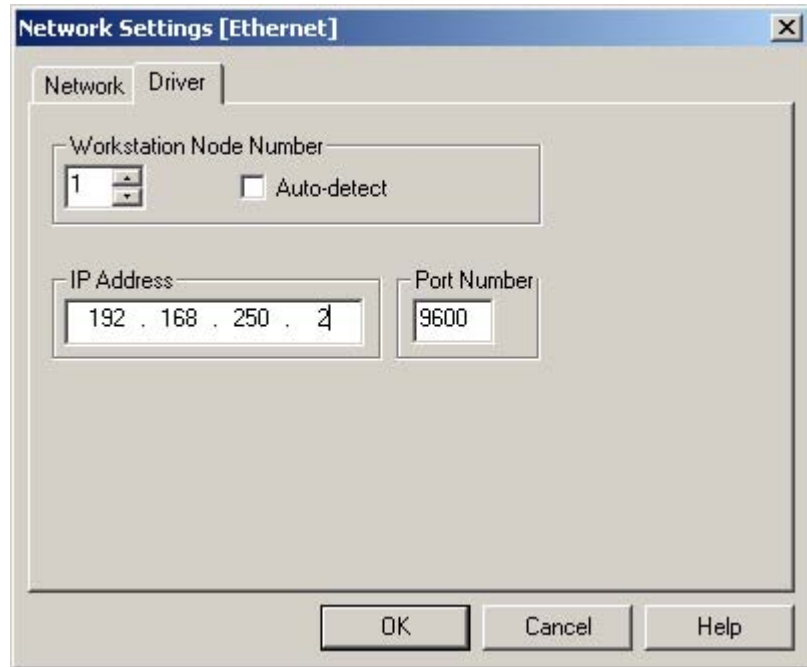

■ **System Configuration Example 2: Going between Networks**

The following conditions must be met to connect online from a CX-Programmer/CX-Net on the primary network of a duplex Ethernet network to a PLC (PLC 3 below) on a Controller Link network via a PLC (PLC 1 below) on a duplex Ethernet network.

Conditions

- Protocol: FINS/UDP
- IP address conversion: Automatic generation method (dynamic)

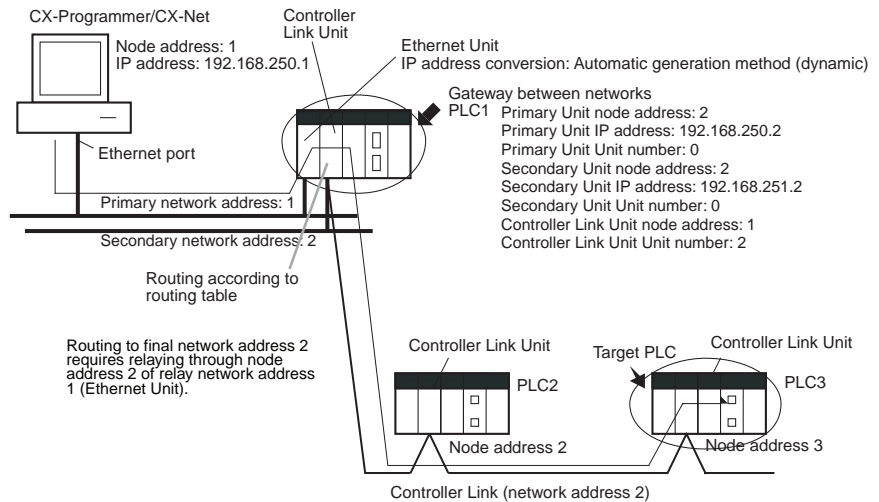

CX-Programmer's Change PLC Dialog Box

Settings for target PLC (PLC3)'s Change PLC Dialog Box	Setting
PLC name	PLC3
Network classification	Ethernet

Settings for target PLC (PLC3)'s Change PLC Dialog Box			Setting
Network Tab	FINS transmission source address		1
	FINS destination address	Network number	3
		Node address	3
	Frame length		2,000 bytes
	Response monitor time		2 seconds
Driver Tab	Workstation node address		1
	Automatic generation method		Not selected
	IP address		192.168.250.2 (Primary Unit IP address)
	Port number		9600

CX-Programmer's Unit Setup

Setup Tab

Same as for *System Configuration Example 1*.

Routing Table Settings and Transfer to Each PLC

Set the routing tables with CX-Net, and transfer them.

- Using CX-Net, connect online, and select **Routing table – Settings**. Then create FINS local routing tables (a local network table and a relay network table).

Example: PLC 1 Routing Table Settings

- Local Network Table

Unit number	Local network number	
0	1	for Primary Unit
1	2	for Secondary Unit
2	3	for Controller Link

- Relay Network Table

None

Example: PLC 2 and PLC 3 Routing Table Settings

- Local Network Table

Unit number	Local network number
0	3

- Relay Network Table

In order to relay from PLC2/3 to the final network number 1, it is necessary to relay via node address 1 (i.e., the Ethernet Unit) on relay network number 3.

Final network number	Relay network number	Relay node address
1	3	1

- Save the routing table file (File - Save local routing table file).
- Select **New** from the Project Menu, and save with a file name. Then select **Add Device** from the Project Menu. For each PLC, register a PLC with a direct serial connection (node address: 0), and select it.
- With CX-Net, select **Open** from the PLC Menu.
- Select **Routing table – Setup**, read the saved file, and select **Options – Transfer to PLC**. Click **Yes** to transfer the routing tables to the connected PLCs.

6-5-2 FinsGateway

FinsGateway Ver. 2003 must be used to communicate using FINS/TCP between applications serving as communications drivers and CS1D-ETN21D CS1D Ethernet Units.

Communicating Using a Duplex Ethernet Network

Install an Ethernet Unit (ETN_UNIT driver) that supports duplex network functions in addition to FinsGateway version 2003 or higher.

Communicating Using FINS/TCP

Install FinsGateway version 2003 or higher.

Communicating Using Only FINS/UDP on a Non-duplex Ethernet Network

Use FinsGateway version 3.□ or lower if desired.

■ Overview of Setup Methods

1. Starting FinsGateway Settings

Select **FinsGateway – FinsGateway Setup** to start the FinsGateway Setup.

2. ETN_UNIT Driver Setup

1. Double-click on **ETN_UNIT** in the settings for the network and Unit. The following ETN_UNIT Properties Window will be displayed.

Network Tab

This is the primary network/unit setting window.

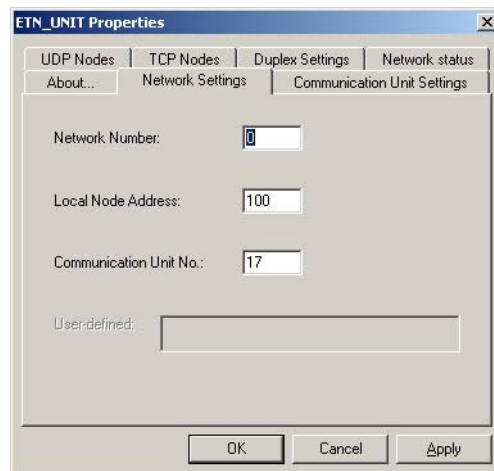

- Network number Set the network number of the primary network for the personal computer (Ethernet port).
- Local node address Set the personal computer (Ethernet port) node address (1 to 254) on the Duplex Ethernet network.
- Communication unit number Set the unit number of the Primary Unit in decimal (16 to 31) for the personal computer (Ethernet port).

Communications Unit Tab

This is the setting window for the Primary Communications Unit.

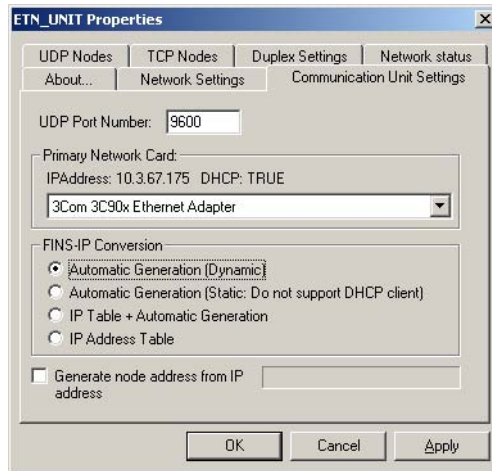

- UDP port number Set the local UDP port number for the personal computer (Ethernet port). The default is 9600.
- Priority Network Card Select the Network Card for the primary network.
- FINS - IP address conversion Set the IP address conversion method.

UDP Nodes Tab: Automatic Generation Method (Dynamic or Passive)

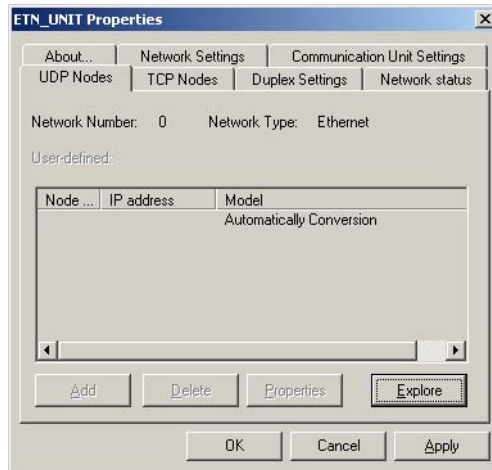

UDP Nodes Tab: IP Address Table Method or Combined Method

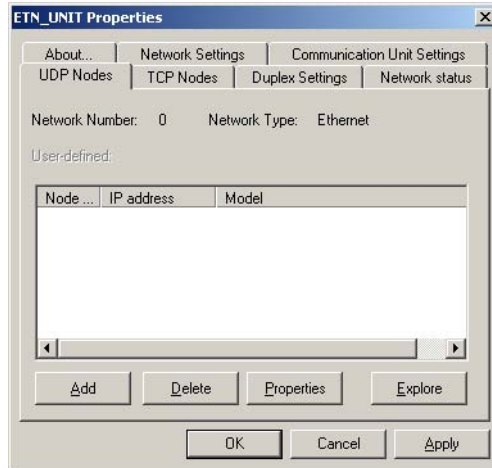

Click the **Add** Button, and then set the IP address table in the following Ethernet Node Definition Dialog Box.

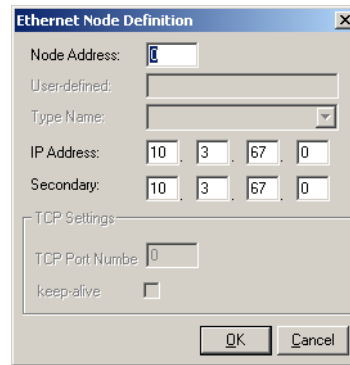

- Node address: Set the remote FINS node address.
- IP address: Set the remote IP address.

TCP Nodes Tab

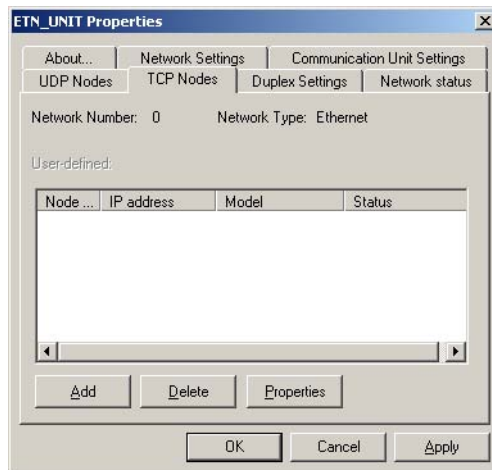

Click the **Add** Button, and then set the IP address table in the following Ethernet Node Definition Dialog Box.

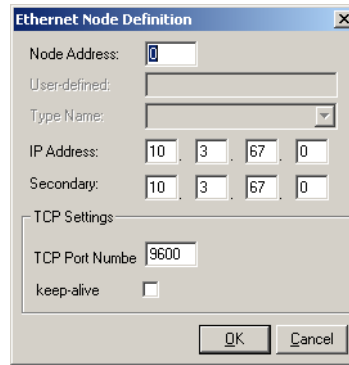

- Node address: Set the remote FINS node address.
- IP address: Set the remote IP address.
- Destination port number: Set the FINS/TCP port number for the remote node. Normally the PLC's default setting of 9600 should be specified.
- Keep-alive setting: Sets the keep-alive function. Normally this should be selected.

Duplex Setup Tab (when Using Duplex Networks)

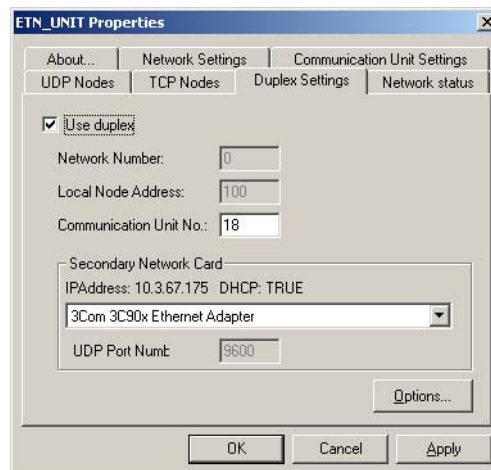

- Use duplex Set Duplex Unit operation when using a duplex Ethernet network.
- Network Number Set the secondary network address.
- Local node address Set the node addresses on the duplex Ethernet network (1 to 124). Use the address setting for the Primary Unit.
- Communications Unit No. Set the Secondary Unit address in decimal (16 to 31). Use one higher than the address of the Primary Unit.
- UDP port number Set the local UDP port number for the personal computer (Ethernet port). The default is 9600.
- Secondary network card Select the Network Card for the secondary network.
- Network status interval time Set the time interval for sending network status via the network status send service. The default is 2 ms.
- Network status watch time Set the monitoring time for detecting a node not participating in the network when receiving status in response to the network status send service. The default is 50 ms.
- Network status UDP port number Set the UDP port number that is used to send network status. The default is 9602.

3. Starting FinsGateway ETN UNIT Service

Select ETN_UNIT from Services under the Basic Tab in the FinsGateway Setup Window, and then click the **Start** Button.

■ System Configuration Example 3: Connecting the CX-Programmer Online Via a Duplex Ethernet Network

The following conditions must be met to connect online from a CX-Programmer/CX-Net on the duplex Ethernet network to a PLC (PLC 1 below) on the duplex Ethernet network

Conditions

- Duplex Ethernet network
- FINS/UDP method
- IP address conversion: Automatic generation method (dynamic)

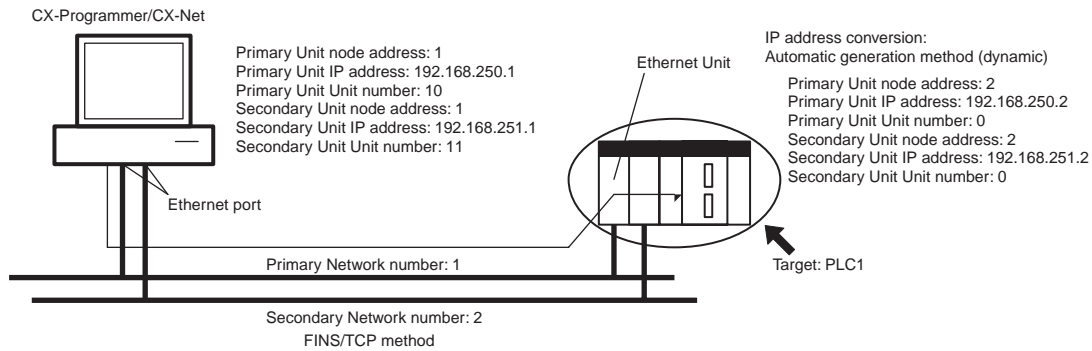

CX-Programmer's Change PLC Dialog Box

Settings for target PLC (PLC1)'s Change PLC Dialog Box			Setting
PLC name			PLC1
Network classification			FinsGateway
Network Tab	FINS destination	Network number	1
		Node address	2
	Frame length		2,000 bytes
	Response monitor time		2 seconds

CX-Programmer's Unit Setup

Setup Tab

Item	Setting
Broadcast	All ones (4.3BSD)
FINS/UDP port	Default (9600)
IP address	0.0.0.0 (Use default IP address.)
Subnet mask	0.0.0.0
Baud rate	Automatic detection
IP router tables	None

FinsGateway ETN UNIT Setup

Network Settings Tab:

Item	Setting
Network number	1
Local node address	1
Communication unit number	10

Communication Unit Settings Tab

Item	Setting
FINS - IP address conversion	Automatic generation (Static: Does not support DHCP client)
UDP port number	9600

Duplex Settings Tab

Item	Setting
Use duplex	Select this option
Network Number	2
Local node address	1
Communications Unit No.	11
UDP port number	Default: 9600
Network status interval time	Default: 2 ms
Network status wait time	Default: 50 ms
Network status UDP port number	Default: 9602

■ **System Configuration Example 4: Connecting the CX-Programmer Online Using FINS/TCP**

In this example, an online connection is made by FINS/TCP to a PLC on an Ethernet network (PLC1 in the diagram below) from a CX-Programmer/CX-Net connected to the Ethernet network.

Conditions

- FINS/TCP method

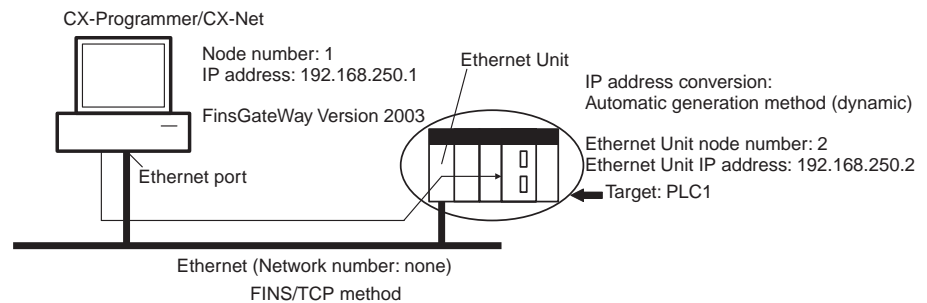

CX-Programmer's Change PLC Dialog Box

Settings for target PLC (PLC1)'s Change PLC Dialog Box			Setting
PLC name			PLC1
Network classification			FinsGateway
Network Tab	FINS destination	Network number	0
		Node address	2
	Frame length		2,000 bytes
	Response monitor time		2 seconds

CX-Programmer's Unit Setup

Setup Tab

Item	Setting
Broadcast	All ones (4.3BSD)
FINS/TCP port	Default (9600)
IP address	0.0.0.0 (Use default IP address.)
Subnet mask	0.0.0.0

Item	Setting
Baud rate	Automatic detection
IP router tables	None

FINS/TCP Tab

Not set. (All defaults are used.)

FinsGateway ETN UNIT Setup**TCP Nodes Tab: Ethernet Node Definition Dialog Box**

Item	Setting
Node address	2
IP address	192.168.250.2
TCP port number	9600
Keep-alive	Selected (yes)

6-6 Communicating between OMRON PLCs

FINS commands can be sent from the user's ladder-diagram program in the PLC by using the SEND(090), RECV(098), and CMND(490) instructions.

SEND(090): Writes I/O data from the local node to another node.

RECV(098): Reads I/O data from another node to the local node.

CMND(490): Issues FINS commands for controlling operations such as sending and receiving I/O memory data to and from other nodes, reading information regarding other nodes, and so on.

6-6-1 Communications Specifications

The following table shows the specifications for PLC communications using the SEND(090), RECV(098), and CMND(490) instructions.

Item	Specifications
Destination	1:1 SEND(090), RECV(098), CMND(490) instructions 1:N SEND(090), CMND(490) instructions (broadcasting)
Data length	SEND(090): 990 words (1,980 bytes) max.; broadcasting: 727 words (1,454 bytes) RECV(098): 990 words (1,980 bytes) max. CMND(490): 1,990 bytes max.; broadcasting: 1,462 bytes (after FINS command code)
Data contents	The following data is sent and received with the execution of each instruction. SEND(090): Sends request for remote node to receive data, and receives response data. RECV(098): Sends request for remote node to send data, and receives response data. CMND(490): Sends any FINS command and receives response data.
Communications port number	Ports 0 to 7 (Eight transmissions can occur simultaneously.)
Response monitor time	0000: 2 s (default) 0001 to FFFF: 0.1 to 6,553.5 s in 0.1-s increments (specified by user)
Number of retries	0 to 15 retries

- Note**
1. The maximum data length is limited to 512 bytes for data exchange between the PLC and SYSMAC LINK Systems or the PLC and SYSMAC BUS/2 Remote I/O Systems.
 2. When broadcasting, do not require a response.
Use the FINS/UDP method for broadcasting.

6-6-2 PLC Communications Data Areas

The following table shows the I/O data areas involved when SEND(090) and RECV(098) are used.

Area	Range
CIO Area	CIO 0000 to CIO 6143
Work Area	W000 to W511
Holding Area	H000 to H511
Auxiliary Area	A000 to A959 (See note 1.)
Timer Area	TIM0000 to 4095
Counter Area	CNT0000 to 4095
DM Area	D00000 to D32767
EM Area	E00000 to E32767 (See note 2.)

- Note**
1. Data cannot be written to words A000 to A447 in the Auxiliary Area.
 2. A maximum of 13 banks in the EM Area can be used. For details regarding the EM Area, refer to the operation manual for the PLC that is used.

6-6-3 Using SEND(090), RECV(098), and CMND(490)

Make the settings shown below when using the SEND(090), RECV(098), and CMND(490) instructions in the user's ladder-diagram program in the PC.

SEND(090)

The SEND(090) instruction sends the data in n number of words, starting from the beginning word S at the local node, to the words starting from the beginning word D at the remote destination node (node address N).

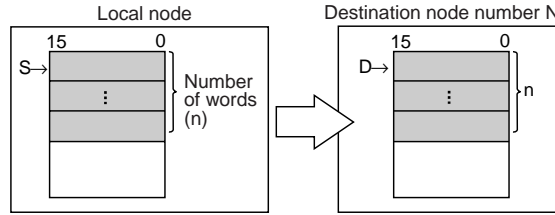

(@)SEND(90)
S
D
C

S: Local node beginning word
 D: Destination beginning word
 C: First word of control data (below)

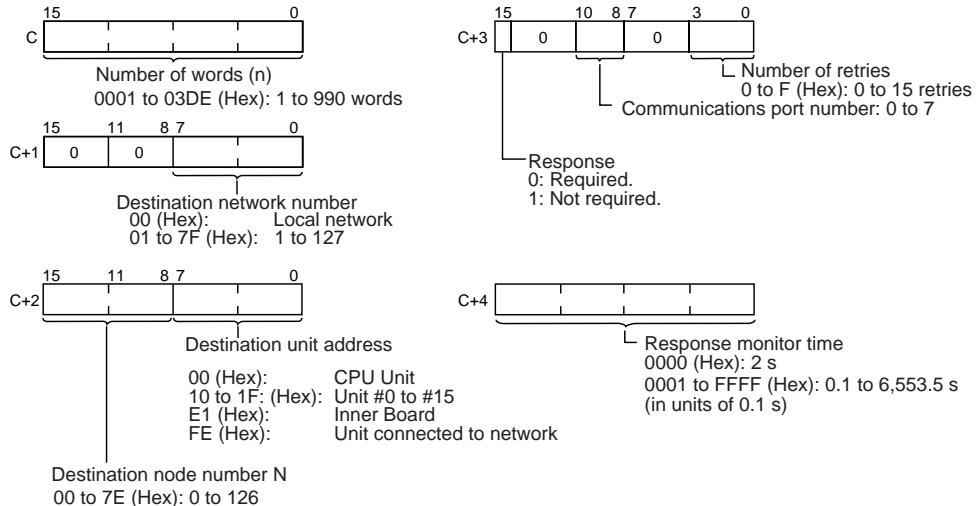

Destination node number N
 00 to 7E (Hex): 0 to 126
 The same data can be broadcast to all nodes on the network by setting the destination node number to FF (Hex).

The range of node addresses is different for networks other than Ethernet.

Note Messages may not always arrive at the destination node for the message service. It is possible for messages to be lost due to noise or when the communications path automatically switches to the secondary network. To handle such problems when using a message service, resend the message from the node sending the command. Refer to the separation detection time for the other node described in 6-7 Network Status Performance when setting the response monitor time. A setting of 1.5 times the separation detection time for other nodes is recommended for the response wait time. The data will be sent again automatically as specified by the resend count with the SEND, RECV, and CMND instructions, so set the resend count to at least 1.

RECV(098)

With the RECV(098) instruction, the data in m number of words, starting from the beginning word S at the remote node (node address M) is received at the words starting from the beginning word D at the local node.

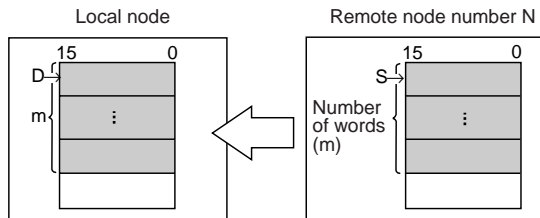

(@)RECV(98)
S
D
C

S: Remote node beginning word
 D: Local beginning word
 C: First word of control data (below)

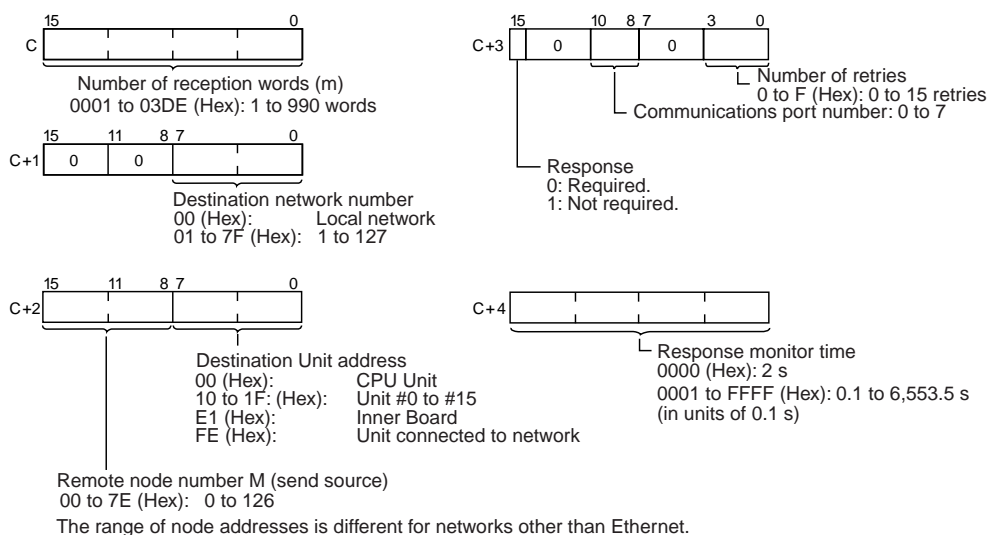

Note Messages may not always arrive at the destination node for the message service. It is possible for messages to be lost due to noise or when the communications path automatically switches to the secondary network. To handle such problems when using a message service, resend the message from the node sending the command. Refer to the separation detection time for the other node described in 6-7 Network Status Performance when setting the response monitor time. A setting of 1.5 times the separation detection time for other nodes is recommended for the response wait time. The data will be sent again automatically as specified by the resend count with the SEND, RECV, and CMND instructions, so set the resend count to at least 1.

CMND(490)

The CMND(490) instruction sends n bytes of command data, starting from the beginning word S at the local node, to the node at node address N. The data in m number of words, starting from the beginning word S at the remote node (node address M) is received at the words starting from the beginning word D at the local node.

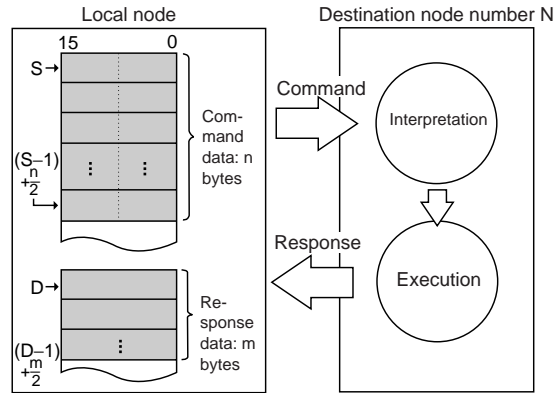

(@)CMND(490)	
S	S: Beginning command storage word
D	D: Beginning response storage word
C	C: First word of control data (below)

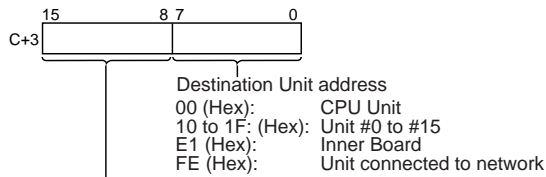
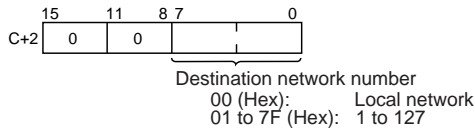
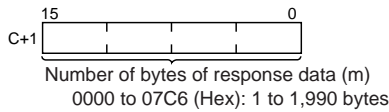
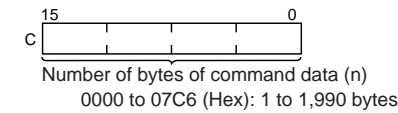

Destination node number N
 00 to 7E (Hex): 0 to 126
 The same data can be broadcast to all nodes on the network by setting the destination node number to FF (Hex).

The range of node addresses is different for networks other than Ethernet.

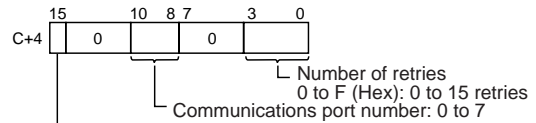

Response
 0: Required.
 1: Not required.

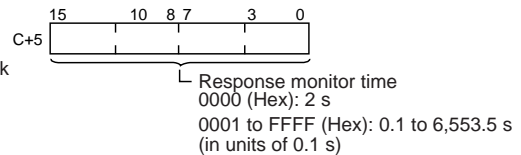

Note Messages may not always arrive at the destination node for the message service. It is possible for messages to be lost due to noise or when the communications path automatically switches to the secondary network. To handle such problems when using a message service, resend the message from the node sending the command. Refer to the separation detection time for the other node described in 6-7 Network Status Performance when setting the response monitor time. A setting of 1.5 times the separation detection time for other nodes is recommended for the response wait time. The data will be sent again automatically as specified by the resend count with the SEND, RECV, and CMND instructions, so set the resend count to at least 1.

Commands Addressed to CS/CJ-series CPU Units

The following table provides a list of FINS commands that can be processed by a CS/CJ-series CPU Unit. For details, refer to the *CS/CJ-series Programmable Controllers Communications Commands Reference Manual (W342)*.

For details on FINS commands that can be processed by the Ethernet Unit, refer to *SECTION 7 FINS Commands Addressed to Ethernet Units*.

Usage	Command code		Name	Function
	MR	SR		
I/O memory area access	01	01	MEMORY AREA READ	Reads the contents of consecutive I/O memory area words.
	01	02	MEMORY AREA WRITE	Writes the contents of consecutive I/O memory area words.
	01	03	MEMORY AREA FILL	Writes the same data to the specified range of I/O memory area words.
	01	04	MULTIPLE MEMORY AREA READ	Reads the contents of specified non-consecutive I/O memory area words.
	01	05	MEMORY AREA TRANSFER	Copies the contents of consecutive I/O memory area words to another I/O memory area.
Parameter area access	02	01	PARAMETER AREA READ	Reads the contents of consecutive parameter area words.
	02	02	PARAMETER AREA WRITE	Writes the contents of consecutive parameter area words.
	02	03	PARAMETER AREA FILL (CLEAR)	Writes the same data to the specified range of parameter area words.
Program area access	03	06	PROGRAM AREA READ	Reads the UM (User Memory) area.
	03	07	PROGRAM AREA WRITE	Writes to the UM (User Memory) area.
	03	08	PROGRAM AREA CLEAR	Clears the UM (User Memory) area.
Operating mode changes	04	01	RUN	Changes the CPU Unit's operating mode to RUN or MONITOR.
	04	02	STOP	Changes the CPU Unit's operating mode to PROGRAM.
Machine configuration reading	05	01	CPU UNIT DATA READ	Reads CPU Unit data.
	05	02	CONNECTION DATA READ	Reads the model numbers of the device corresponding to addresses.
Status reading	06	01	CPU UNIT STATUS READ	Reads the status of the CPU Unit.
	06	20	CYCLE TIME READ	Reads the maximum, minimum, and average cycle time.
Time data access	07	01	CLOCK READ	Reads the present year, month, date, minute, second, and day of the week.
	07	02	CLOCK WRITE	Changes the present year, month, date, minute, second, or day of the week.
Message display	09	20	MESSAGE READ/CLEAR	Reads and clears messages, and reads FAL/FALS messages.
Access rights	0C	01	ACCESS RIGHT ACQUIRE	Acquires the access right as long as no other device holds it.
	0C	02	ACCESS RIGHT FORCED ACQUIRE	Acquires the access right even if another device already holds it.
	0C	03	ACCESS RIGHT RELEASE	Releases the access right that has been acquired.
Error log	21	01	ERROR CLEAR	Clears errors or error messages.
	21	02	ERROR LOG READ	Reads the error log.
	21	03	ERROR LOG POINTER CLEAR	Clears the error log pointer.

Usage	Command code		Name	Function
	MR	SR		
File memory	22	01	FILE NAME READ	Reads file memory data.
	22	02	SINGLE FILE READ	Reads a specified length of file data from a specified position within a single file.
	22	03	SINGLE FILE WRITE	Writes a specified length of file data from a specified position within a single file.
	22	04	FILE MEMORY FORMAT	Formats (initializes) the file memory.
	22	05	FILE DELETE	Deletes specified files stored in the file memory.
	22	07	FILE COPY	Copies files from one file memory to another file memory in the same system.
	22	08	FILE NAME CHANGE	Changes a file name.
	22	0A	MEMORY AREA-FILE TRANSFER	Transfers or compares data between the I/O memory area and the file memory.
	22	0B	PARAMETER AREA-FILE TRANSFER	Transfers or compares data between the parameter area and the file memory.
	22	0C	PROGRAM AREA-FILE TRANSFER	Transfers or compares data between the UM (User Memory) area and the file memory.
	22	15	CREATE/DELETE DIRECTORY	Creates or deletes a directory.
Debugging	23	01	FORCED SET/RESET	Force-sets or force-resets bits, or releases force-set status.
	23	02	FORCED SET/RESET CANCEL	Cancels all bits that have been force-set or force-reset.

6-6-4 Writing Programs

Programs incorporating the SEND(090), RECV(098), and CMND(490) instructions are generally created using the Communications Port Enabled Flag and the Communications Port Error Flag as input conditions. CS/CJ-series CPU Units have eight communications ports. Only one instruction can be executed at any given port at one time, however, so the program must not overlap the use of any of the ports. A program example is provided below.

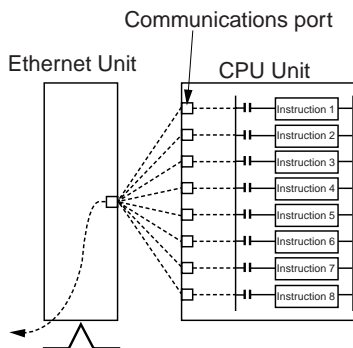

There are eight communications ports, so up to eight communications instructions can be executed at a time. The number of messages that can be sent or received with a single CPU Bus Unit service, though, is not more than two each for the CPU Unit to the Ethernet Unit and for the Ethernet Unit to the CPU Unit.

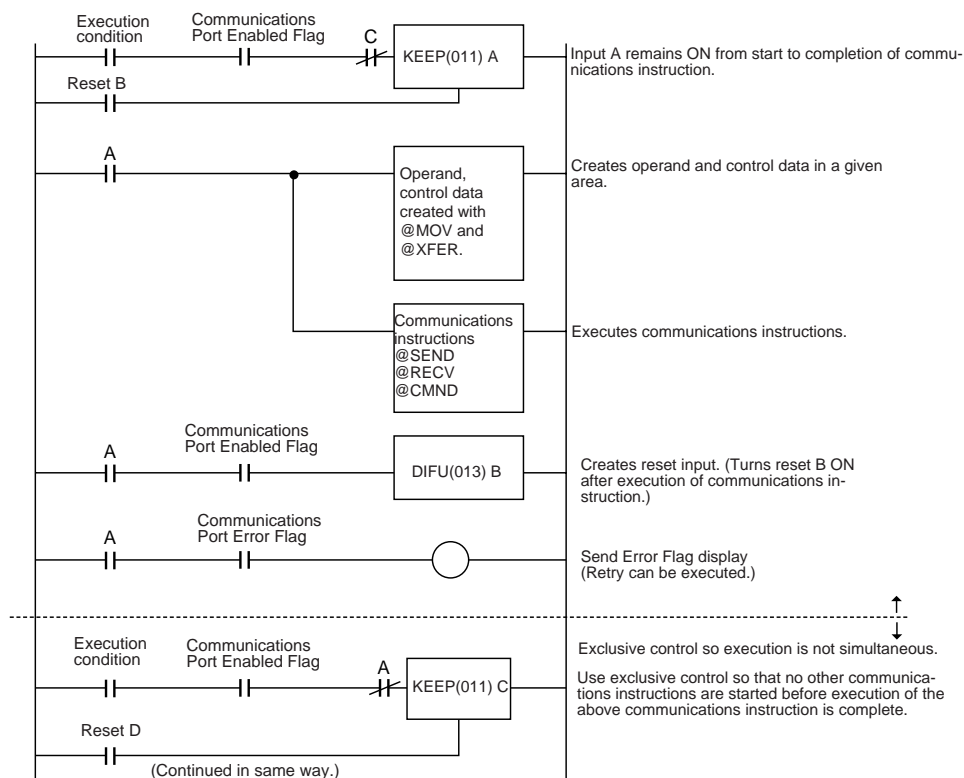

The execution status of the SEND(090), RECV(098), and CMND(490) instructions is always reflected by the communications flags (i.e., the Communications Port Enabled Flag and the Communications Port Error Flag). The CS/CJ-series CPU Unit's communications flags are allocated in the Auxiliary Area as shown in the following table.

Flag name	Address		Contents
	Word	Bits	
Communications Port Enabled Flag	A202	Bit 7: Port 7 Bit 6: Port 6 Bit 5: Port 5 Bit 4: Port 4 Bit 3: Port 3 Bit 2: Port 2 Bit 1: Port 1 Bit 0: Port 0	OFF: Execution enabled (being executed) ON: Execution disabled (not being executed)
Communications Port Error Flag	A219	Bit 7: Port 7 Bit 6: Port 6 Bit 5: Port 5 Bit 4: Port 4 Bit 3: Port 3 Bit 2: Port 2 Bit 1: Port 1 Bit 0: Port 0	0: Normal completion 1: Abnormal completion

Note With CS/CJ-series PLCs, communications ports 0 to 7 are also used for executing the PCMR(260) (PROTOCOL MACRO) instruction, or Simple Backup Function, so these flags are used in common for SEND(090), RECV(098), CMND(490), and PCMR(260). While PCMR(260) is being executed, SEND(090), RECV(098), and CMND(490) cannot be executed at the same communications port.

Communications Port Completion Codes

The status of a SEND(090), RECV(098), and CMND(490) instruction after execution is reflected as a communications port completion code, in one word (two bytes) of data as shown in the following table. (The value is 0000 during instruction execution.) The recorded status is saved until execution of the next instruction.

Word	Contents
A203	Communications Port 0 Completion Code
A204	Communications Port 1 Completion Code
A205	Communications Port 2 Completion Code
A206	Communications Port 3 Completion Code
A207	Communications Port 4 Completion Code
A208	Communications Port 5 Completion Code
A209	Communications Port 6 Completion Code
A210	Communications Port 7 Completion Code

The meanings of the communications port completion codes are the same as those for FINS commands and responses. When CMND(490) is used, however, even if a FINS command has an abnormal completion, it will not be reflected in the communications port completion code. For details, refer to *Communications Port Error Flag and Completion Codes for CMND(490)* below.

Bits 08 to 15 in the communications port completion code correspond to the first byte of the response code, and bits 00 to 07 correspond to the second byte. For details, refer to *8-5 Troubleshooting with Response Codes*.

Communications Port Error Flag and Completion Codes CMND(490)

Errors that occur when CMND(490) is used generate a Communications Port Error Flag and are recorded in a communications port completion code only in the following cases:

- When a response timeout error has occurred.
- When the number of communications data bytes exceeds the maximum value for the Unit (i.e., 2,000 bytes for the Ethernet Unit).
- When the actual number of response bytes is greater than the number of reception bytes that has been set. (The response is not stored in this case.)

Errors other than these are recorded in the response codes of the responses stored from the beginning response storage word onwards. Be careful of these, because there are no Communications Port Error Flags and they are not recorded in a communications port completion code.

Timing of Communications Flag Changes

- The Communications Port Enabled Flag remains OFF during communications and turns ON when they are completed (regardless of whether or not an error occurs).
- The Communications Port Error Flag retains its status until the next transmission or reception.
- The Communications Port Error Flag turns OFF with the execution of the next communications instruction even if there was an abnormal completion.

Example

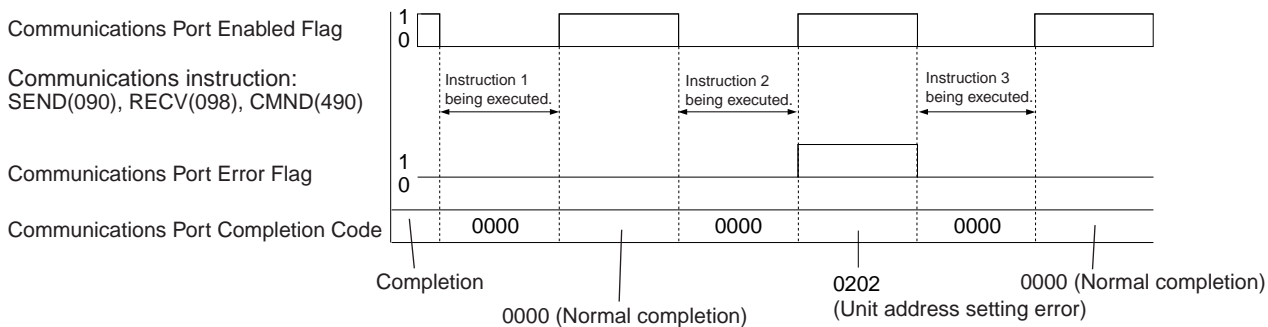

6-6-5 Program Example

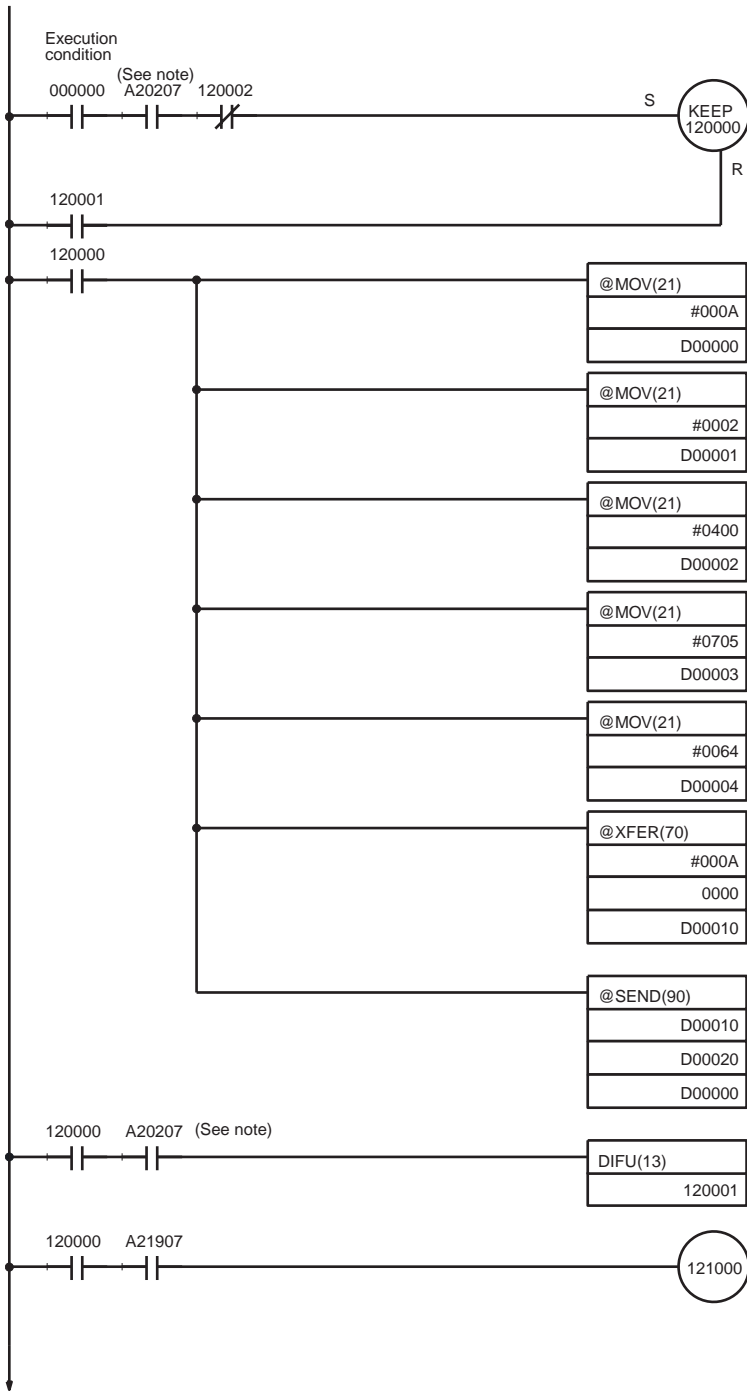

When the Communications Port Enabled Flag for port 7 is ON, and RECV(098) is not being executed, the send execution program will start when execution condition CIO 000000 turns ON.

Input CIO 120000 remains ON from the start of SEND(090) execution until completion.

Control Data Creation

Word	Contents	Meaning
D0000	00 0A	Number of send words = 10
D0001	00 02	Destination network number = 2
D0002	04 00	Destination node number = 4 Destination unit address = 0
D0003	07 05	Response required. Communications port No. used = 7 Number of retries = 5
D0004	00 64	Response monitor time = 10 s

Send Data Creation

Ten words of data from word CIO 0000 is stored from D00010 onwards.

Ten words of data from D00010 at the local node is sent to D00020 onwards at network number 2, node number 4, unit address 0 (the PC).

Reset Input Creation

Send Error Display

(Continued on next page.)

(Continued from previous page.)

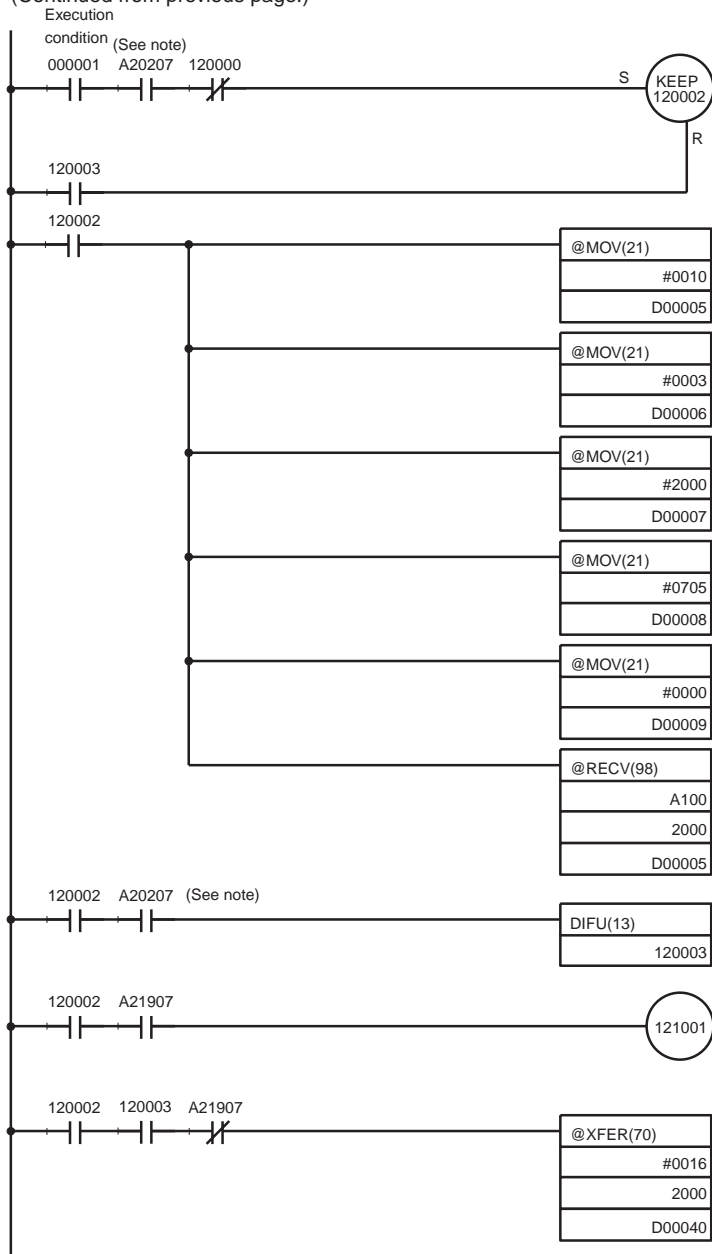

When the Communications Port Enabled Flag for port 7 is ON, and SEND(090) is not being executed, the transmission execution program will start when execution condition CIO 000001 turns ON.

Input CIO 120002 remains ON from the start of RECV(098) execution until completion.

Control Data Creation

Word	Contents	Meaning
D0005	00 10	Number of reception words = 16
D0006	00 03	Source network number = 3
D0007	20 00	Source node number = 32 Source unit address = 0
D0008	07 05	Response required. Communications port No. used = 7 Number of retries = 5
D0009	00 00	Response monitor time = Default

A total of 16 words of data beginning from word A100 at network number 3, node number 32, unit address 0 (the PC) is received at word CIO 2000 onwards of the local node.

Reset Input Creation

Reception Error Display

Reception Data Processing

If there is no reception processing completion error, the 16 words of data received from word CIO 2000 onwards is stored at D00040 onwards.

- Note**
1. With CS/CJ-series PCs, the Communications Port Enabled Flags at bits 0 to 7 in word A202 turn OFF even when the PCMR(260) instruction is being executed using the ports corresponding to those flags.
 2. Before using the sample program as is, confirm that the memory areas (words and bits) used in the sample program are not already being used in the user program or by Special I/O Units.

6-6-6 Transmission Delays (Ignoring Network Delays)

The methods of computing the maximum time required from execution of the SEND(090), RECV(098), and CMND(490) instructions until processing is completed are described in this section.

SEND(090)

The transmission delay for the SEND(090) instruction can be calculated using the following equation, which is illustrated in the following diagram.

$$\begin{aligned} \text{Max. delay} = & \text{CPU Bus Unit service cycle (local node)} \\ & + \text{CPU Bus Unit service processing time (local node)} \\ & + \text{Transmission processing time} \\ & + \text{Transmission Delays} \\ & + \text{Reception processing time} \\ & + \text{CPU Bus Unit service cycle (remote node)} \\ & + \text{CPU Bus Unit service processing time (remote node)} \end{aligned}$$

The following delays comprising the maximum transmission delay time occur when operation switches automatically to the secondary system following an error in the primary network path.

$$\begin{aligned} \text{Automatic switching} \\ \text{delay time} = & \text{CPU Bus Unit service cycle (local node)} \\ & + \text{CPU Bus Unit service processing time (local node)} \end{aligned}$$

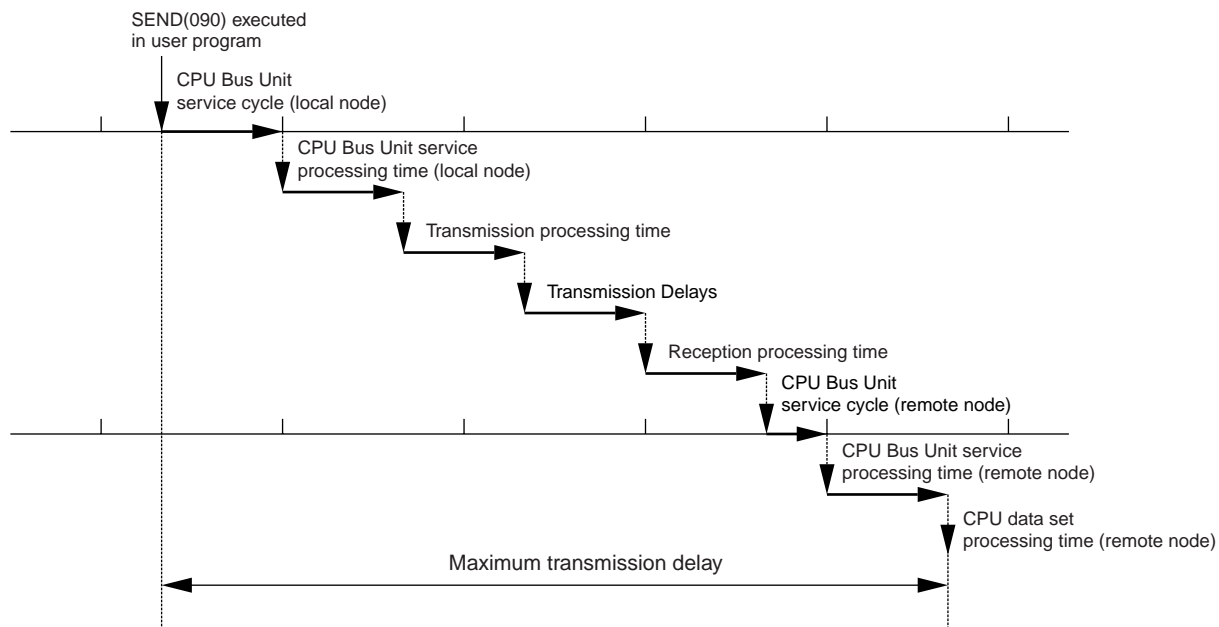

CPU Bus Unit Service Cycle (Local Node)

The processing time will be as follows, depending on the CPU processing mode settings at the CPU Unit:

CPU execution mode	Processing time considerations
Normal Mode	CPU Unit cycle time

For details, refer to the CPU Unit operation manual.

CPU Bus Unit Service Processing Time (Local Node)

The processing time will be as follows, depending on the CPU processing mode settings at the CPU Unit:

CPU execution mode	Processing time considerations
Normal Mode	Set time for peripheral servicing (Default: 4% of CPU Unit cycle time)

For details, refer to the CPU Unit operation manual.

Transmission Processing Time

Number of words sent x 0.002 + 0.550 ms

Transmission Delay

The transmission delay time will be as given below, depending on the baud rate set for the Ethernet Unit. (There may be additional delays depending on devices, such as hubs, in the network configuration.)

Baud rate	Delay time
100Base-TX	Number of words sent x 0.0013 + 0.0118 ms
10Base-T	Number of words sent x 0.0019 + 0.0157 ms

Reception Processing Time

Number of words sent x 0.003 + 0.704 ms

CPU Bus Unit Service Cycle (Remote Node)

CPU Unit cycle time

For details, refer to the CPU Unit operation manual.

CPU Bus Unit Service Processing Time (Remote Node)

Set time for peripheral servicing (Default: 4% of CPU Unit cycle time)

For details, refer to the CPU Unit operation manual.

Note The transmission processing time may be longer than calculated depending on actual operating conditions. This could be the result of several factors, such as the network load (line traffic), the node window sizes, the Ethernet Unit load, and the system configuration.

Example Calculations

The following table provides a guideline for the maximum transmission delay time under the following conditions.

Conditions:

Local node CPU cycle time: 10 ms

Local node CPU uniform peripheral servicing time: Default (4%)

Remote node CPU cycle time: 5 ms

Remote node CPU peripheral servicing time: Default (4%)

Baud rate: 100Base-TX

Item	Calculation
CPU Bus Unit service cycle (local node)	10 ms
CPU Bus Unit service processing time (local node)	0.4 ms
Transmission processing time	$256 \times 0.002 + 0.550 = 1.062 \approx 1.1$ ms
Transmission delay	$256 \times 0.0013 + 0.0118 = 0.3446 \approx 0.3$ ms
Reception processing time	$256 \times 0.003 + 0.704 = 1.472 \approx 1.5$ ms

Item	Calculation
CPU Bus Unit service cycle (remote node)	5 ms
CPU Bus Unit service processing time (remote node)	0.2 ms
Total	10 + 0.4 + 1.1 + 0.3 + 1.5 + 5 + 0.2 = 18.5 ms

RECV(098)

The transmission delay for the RECV(098) instruction can be calculated using the equation illustrated in the following diagram.

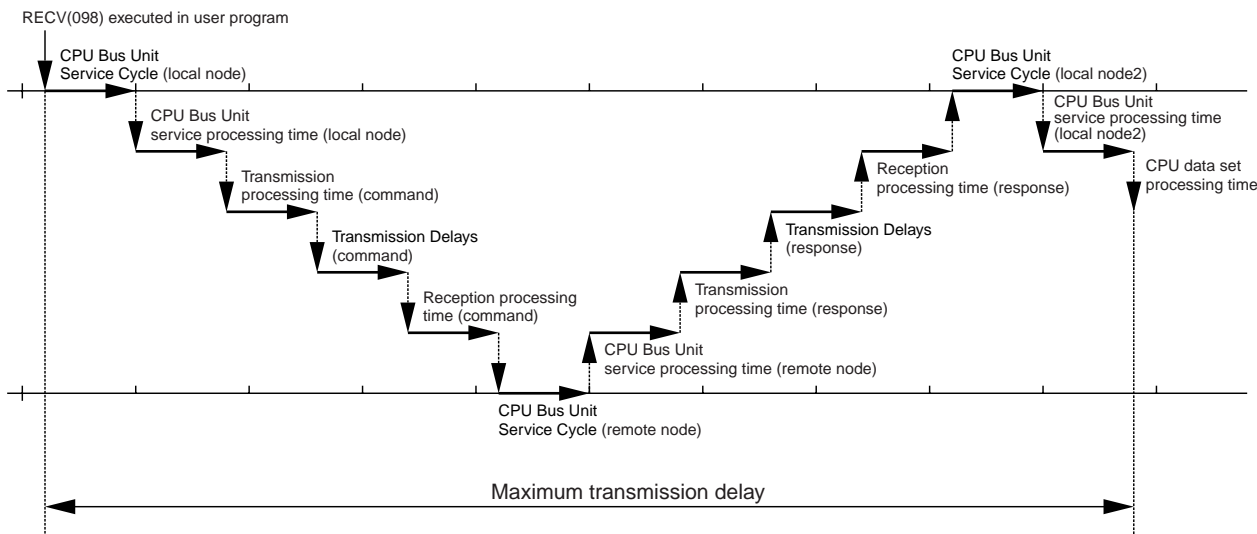

Maximum transmission delay time

- + CPU Bus Unit Service Cycle (local node 1)
- + CPU Bus Unit service processing time (local node 1)
- + Transmission processing time (command)
- + Transmission delay (command)
- + Reception processing time (command)
- + CPU Bus Unit Service Cycle (remote node)
- + CPU Bus Unit service processing time (remote node)
- + Transmission processing time (response)
- + Transmission Delays (response)
- + Reception processing time (response)
- + CPU Bus Unit Service Cycle (local node 2)
- + CPU Bus Unit service processing time (local node 2)

The following delays comprising the maximum transmission delay time occur when operation switches automatically to the secondary system following a failure in the primary network path.

Automatic switching delay time =

- + CPU Bus Unit Service Cycle (local node)
- + CPU Bus Unit service processing time (local node)
- + CPU Bus Unit Service Cycle (remote node) X 2
- + CPU Bus Unit service processing time (remote node) X 2

CPU Bus Unit Service Cycle (Local Node 1)

CPU Unit cycle time

For details, refer to the CPU Unit operation manual.

CPU Bus Unit Service Processing Time (Local Node 1)

Set peripheral servicing time (Default: 4% of CPU Unit cycle time)

For details, refer to the CPU Unit operation manual.

Transmission Processing Time (Command)

Command	0.550 ms
Response	Number of words sent × 0.002 + 0.550 ms

Transmission Delay (Command)

The transmission delay time will be as follows, depending on the baud rate set for the Ethernet Unit. (There may be additional delays depending on devices such as hubs in the network configuration.)

Baud rate	Delay time	
100Base-TX	Command	0.0118 ms
	Response	Number of words sent × 0.0013 + 0.0118 ms
10Base-T	Command	0.0157 ms
	Response	Number of words sent × 0.0019 + 0.0157 ms

Reception processing time (command)

Command	0.704ms
Response	Number of words sent × 0.003 + 0.704 ms

CPU Bus Unit Service Cycle (Remote Node)

CPU Unit cycle time

For details, refer to the CPU Unit operation manual.

CPU Bus Unit Service Processing Time (Remote Node)

Set time for peripheral servicing (Default: 4% of CPU Unit cycle time)

For details, refer to the CPU Unit operation manual.

CPU Bus Unit Service Cycle (Local Node 2)

CPU Unit cycle time

For details, refer to the CPU Unit operation manual.

CPU Bus Unit Service Processing Time (Local Node 2)

Set time for peripheral servicing (Default: 4% of CPU Unit cycle time)

For details, refer to the CPU Unit operation manual.

Note The transmission processing time may be longer than calculated depending on actual operating conditions. This could be the result of several factors, such as the network load (line traffic), the node window sizes, the Ethernet Unit load, and the system configuration.

Example Calculation:
Receiving 256 Words Using RECV between Two PLCs)

The following table provides a guideline for the maximum transmission delay time under the following conditions.

Conditions:

Local node CPU cycle time: 10 ms

Local node CPU uniform peripheral servicing time:Default (4%)

Remote node CPU cycle time: 15 ms

Remote node CPU uniform peripheral servicing time:Default (4%)

Baud rate:100Base-TX

Item	Calculations
CPU Bus Unit service cycle (local node 1)	10 ms
CPU Bus Unit service processing time (local node 1)	0.4 ms
Transmission processing time (command)	0.550 ms ≈ 0.5 ms
Transmission delay (command)	0.0118 ms ≈ 0.1ms
Reception processing time (command)	0.704 ms ≈ 0.7 ms
CPU Bus Unit service cycle (remote node)	15 ms
CPU Bus Unit service processing time (remote node)	0.6 ms
Transmission processing time (response)	$256 \times 0.002 + 0.550 = 1.062 \approx 1.1$ ms
Transmission delay (response)	$256 \times 0.0013 + 0.0118 = 0.3446 \approx 0.3$ ms
Reception processing time (response)	$256 \times 0.003 + 0.704 = 1.472 \approx 1.5$ ms
CPU Bus Unit service cycle (local node 2)	10 ms
CPU Bus Unit service processing time (local node 2)	0.4 ms
Total	$10 + 0.4 + 0.5 + 0.1 + 0.7 + 15 + 0.6 + 1.1 + 0.3 + 1.5 + 10 + 0.4 = 40.6$ ms

6-7 Network Status Performance

Network status is periodically broadcast on the network to monitor the participation of the nodes on the network.

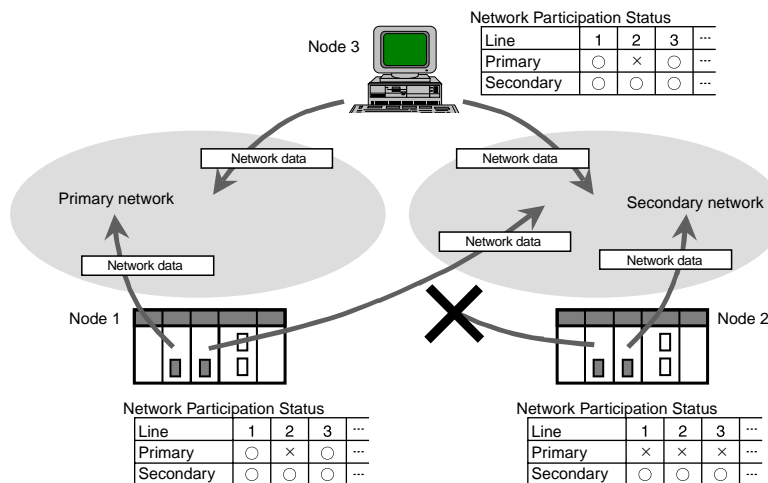

Total Network Status Send Time

Network status is sent to nodes in ascending order of node numbers. The time required for the network status to be sent once each to all nodes in the network is the sum of the time for each node participating in the network. This value can be calculated as follows:

Total network status send time = Σ (Network status send time + Network status send interval)

Item	Time
Network status send time	0.550 ms
Network status send interval	Set in Unit Setup

Node Separation Detection Time

If, after a node has once participated in the network, a response is not received from the node after network status has been sent to all nodes three times, it is assumed that the node has been separated from the network. The time required to detect that a node has been separated from the network can be calculated as follows:

Node separation detection time = (Total network status send time + Network status wait time) x 3

Item	Time
Total network status send time	As described above
Network status send interval	Set in Unit Setup

- Note**
- (1) All FINS messages sent to a node while it is separated will be lost.
 - (2) Consider the node separation detection time when setting the response monitor time for FINS messages sent for the SEND, RECV, and CMND instructions. The response monitoring time should generally be set to 1.5 times the node separation detection time.
 - (3) If the response monitoring time is too long, reconsider the network status send interval and network status wait time.

6-8 Precautions on High Traffic in FINS Communications

When applications are constructed using FINS communications services, communications errors (from multiple response timeouts) may occasionally occur due to high traffic, depending on the system configuration and the application programs. This section describes precautions for systems with high traffic in FINS communications.

■ Conditions for High Traffic

High traffic may occur if FINS messages from multiple communicating nodes are concentrated at a single Ethernet Unit. The Ethernet Unit and the CPU Unit may have insufficient processing capacity for the volume of FINS messages (commands) that are coming from the network.

For example, suppose that approximately 20 ms are required to process a single FINS frame (i.e., 20 ms from the time that the command is received at the Ethernet Unit until a response is sent). If 100 or more FINS frames (commands) are received at once from multiple communicating nodes, it will take approximately 2 seconds to send a response to the last command. If a timeout is set at the remote node for 2 seconds or less, then a timeout will be generated. A retry will begin due to the timeout, and the traffic to the Ethernet Unit will thus be increased even further, until ultimately the responses to all the nodes will be too slow. At this point, the system is overloaded.

■ Avoiding Errors due to High Traffic

To avoid high traffic from FINS communications, the communications load must be kept down to a reasonable level. To accomplish this, follow the procedure below.

1. Specify the node where FINS frames seem to be concentrated.

2. Referring to *6-6-6 Transmission Delays (Ignoring Network Delays)*, estimate the total processing time for all of the FINS frames processed at that node.
3. Set the timeout value for all of the SEND(090), RECV(098), and CMND(490) FINS commands at all the remote nodes to at least 1.5 times the total processing time for all of the FINS frames.
4. As much as possible, implement communications traffic testing up to the point of actual system operation. If any problem occurs, adjust the traffic.
5. If a commercially-available protocol analyzer can be used, then the actual FINS frame processing time (i.e., the time from when a command is received at the Ethernet Unit until a response is sent) can be measured under high traffic conditions and the communications traffic can be further adjusted as required.

SECTION 7

FINS Commands Addressed to Ethernet Units

This section describes the FINS commands that can be sent to an Ethernet Unit and the responses that are returned by the Ethernet Unit.

7-1	Command Codes and Response Codes	134
7-1-1	Command Code List	134
7-1-2	Response Code List	134
7-2	Command/Response Reference	135
7-2-1	RESET	135
7-2-2	CONTROLLER DATA READ	136
7-2-3	CONTROLLER STATUS READ	137
7-2-4	NETWORK STATUS READ	139
7-2-5	INTERNODE ECHO TEST	140
7-2-6	BROADCAST TEST RESULTS READ	141
7-2-7	BROADCAST DATA SEND	141
7-2-8	ERROR LOG READ	141
7-2-9	ERROR LOG CLEAR	143
7-2-10	PING	143
7-2-11	FINS/TCP CONNECTION REMOTE NODE CHANGE REQUEST	144
7-2-12	FINS/TCP CONNECTION STATUS READ	145
7-2-13	IP ADDRESS TABLE WRITE	146
7-2-14	IP ADDRESS WRITE	147
7-2-15	IP ADDRESS TABLE READ	148
7-2-16	IP ROUTER TABLE READ	149
7-2-17	PROTOCOL STATUS READ	151
7-2-18	MEMORY STATUS READ	155
7-2-19	SOCKET STATUS READ	157
7-2-20	ADDRESS INFORMATION READ	158
7-2-21	IP ADDRESS READ	159

MRES	Execution results
04	Service not supported
05	Routing error
10	Command format error
11	Parameter error
22	Status error
23	Operating environment error
25	Unit error

7-2 Command/Response Reference

This section describes the FINS commands that can be sent to Ethernet Units and the responses to each command.

Command Name

The command name is provided as the heading of each section

Function

The function of the command is given after the command name

Command Block

The format of the command and command code are given. Each square in the command format represents one byte.

Response Block

The format of the response is given. Each square in the response format represents one byte.

Parameters

The meaning, setting range, and other information is provided on the parameters.

Precautions

Precautions for using the command are provided where applicable.

Response Codes

The codes returned in response to executing the command are explained.

Note Except for special cases, all send/receive data is in hexadecimal format.

7-2-1 RESET

Resets the Ethernet Unit.

Command Block

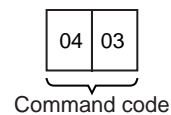

Response Block

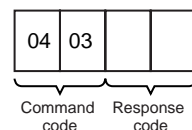

Precautions

No response will be returned if the command ends normally. A response will be returned only if an error occurs.

In some cases, send requests (SEND(192)/RECV(193) instructions) made from the PLC to the Ethernet Unit just before execution of the RESET command may not be executed.

Except for the FINS communications service sockets, all open sockets (for sockets services, FTP server, or mail transmission) are closed immediately before resetting.

Response Codes

Response code	Description
1001	Command too large

7-2-2 CONTROLLER DATA READ

Reads the following data from the Ethernet model, version, IP address, subnet mask, FINS UDP port number, mode settings, Ethernet address.

Command Block

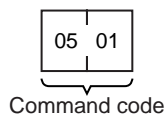

Response Block

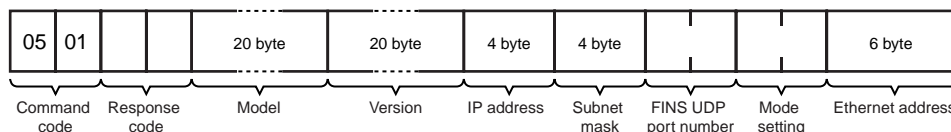

Parameters

Model, Version (Response)

The CS1D Ethernet Unit mode and version are returned as ASCII characters occupying 20 bytes each (i.e., 20 characters each). If all bytes are not used, the remaining bytes will be all spaces (ASCII 20 Hex).

Example Model: CS1D-ETN21D
Version: V1.00

IP Address, Subnet Mask (Response)

The Ethernet Unit's IP address and subnet mask are returned as 4 bytes each.

FINS UDP Port Number (Response)

The Ethernet Unit's UDP port number for FINS is returned as 2 bytes.

Mode Setting (Response)

The mode setting in the system setup is returned.

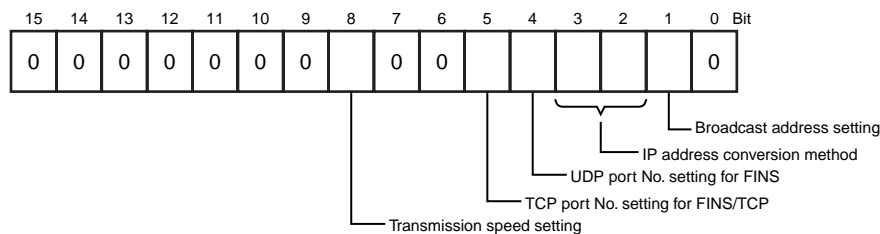

Broadcast Address Setting

- 0: Broadcast with host number set to all ones (4.3BSD specifications)
- 1: Broadcast with host number set to all zeroes (4.2BSD specifications)

IP Address Conversion Method Setting

- 00, 01: Automatic generation method
- 10: IP address table reference method
- 11: Combined method (IP address table reference + automatic generation)

FINS/UDP Port Number Setting

- 0: Default (9600)
- 1: Unit Setup value

FINS/TCP Port Number Setting

- 0: Default (9600)
- 1: Unit Setup value

Baud Rate setting

- 0: Automatic detection

Ethernet Address (Response)

The Ethernet address of the Ethernet Unit is returned. The Ethernet address is the address marked on the label on the side of the Ethernet Unit.

Response Codes

Response code	Description
0000	Normal
1001	Command too large

7-2-3 CONTROLLER STATUS READ

Reads the controller status.

Command Block

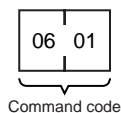

Response Block

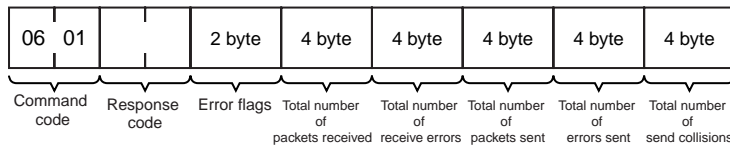

Parameters

Error Flags (Response)

Indicates the operating status and errors that occurred when the Ethernet Unit was started.

Bits will turn ON to indicate errors that have occurred.

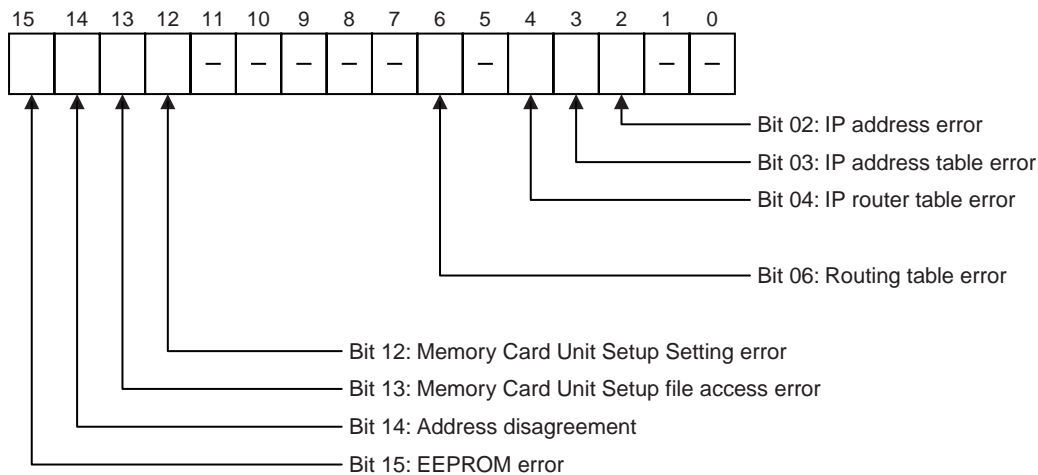

The cause of each error is listed below.

IP Address Error

All bits for the network number or host number are set to 0 or 1.

IP Address Table Error

More than 32 records exist in the IP address table.

IP Router Table Error

More than 8 records exist in an IP router table.

Routing Table Error

Local network table contains 0 or more than 16 records.
Relay network table contains more than 20 records.

Memory Card Unit Setup Setting Error

There is an error in a setting in the Unit Setup file on the Memory Card.

Memory Card Unit Setup Access Error

There was an error in accessing the Unit Setup file on the Memory Card.

Address Disagreement

The address conversion method was set for automatic generation, but the node address and the last byte of the local IP address do not agree, or other host sections are 0.

EEPROM Error

An error occurred in the EEPROM memory in the Ethernet Unit.

Total Number of Packets Received (Response)

The total number of packets received by the Ethernet Unit is returned.

Total Number of Receive Errors (Response)

The total number of errors detected while the Ethernet Unit was receiving is returned. The types of error detected are short packet errors, alignment errors, CRC errors, frame length errors (received frame: 1,515 bytes or more), and communications controller overflow errors.

Total Number of Packets Sent (Response)

The total number of packets sent by the Ethernet Unit is returned.

Total Number of Errors Sent (Response)

The total number of packet errors detected while the Ethernet Unit was sending is returned.

Total Number of Send Collisions (Response)

The number of packets damaged by 16 collisions with data from other nodes during Ethernet Unit transmissions.

Precautions

Counting of the total number of packets received, total number of receive errors, total number of packets sent, total number of errors sent, and total number of send collisions is discontinued when the counted value reaches the maximum value.

Response Codes

Response code	Description
0000	Normal
1001	Command too large

7-2-4 NETWORK STATUS READ

Reads the Ethernet network status.

Command Block

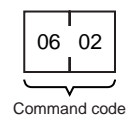

Response Block

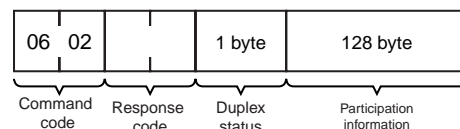

Parameters

Duplex Status (Response) The local duplex status is returned, as follows:

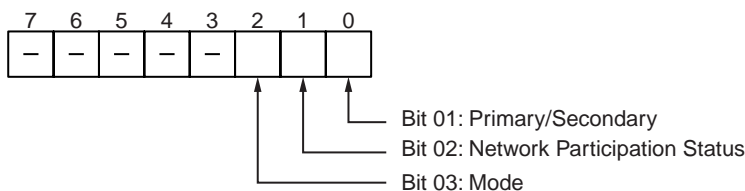

The cause of each error is listed below.

Primary/Secondary

- 0: Secondary Unit
- 1: Primary Unit

Network Participation Status

- 0: Not participating in network
- 1: Participating in network

Mode

- 0: Simplex network mode
- 1: Duplex network mode

Participation Status (Response)

The status of participation in the duplex Ethernet network is returned. As shown below, 4 bits are used to give the participation status for each node address.

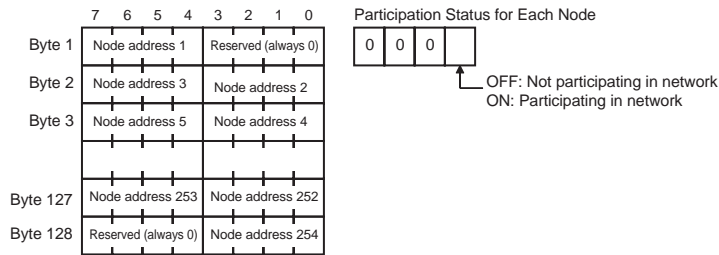

Response Codes

Response code	Description
0000	Normal
1001	Command too large

7-2-5 INTERNODE ECHO TEST

Runs the echo test between specified nodes.

Command Block

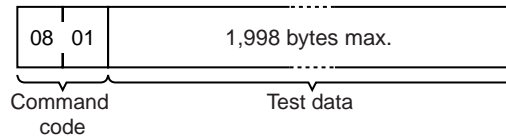

Response Block

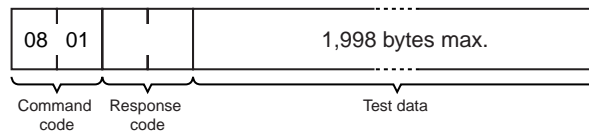

Parameters

Test Data (Command, Response)

This command specifies the data to be sent to the specified nodes. Up to 1,998 bytes can be specified. The response sends back data identical to the data specified in the command. An abnormality is assumed if the data returned in the response differs from the test data sent.

Precautions

The test destination node is the destination node specified in the CMND(194) instruction operands.

Always specify the unit address of the Ethernet Unit in the CMND(194) instruction.

Response Codes

Response code	Description
0000	Normal
1001	Command too large
1002	Command too small (No test data)

7-2-6 BROADCAST TEST RESULTS READ

Reads the results (number of times data received) of the broadcast test.

Command Block



Response Block

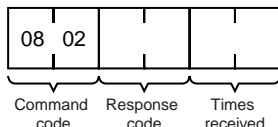

Parameters

Times Received (Response)

The number of times the data has been received normally during the broadcast send test is returned as a hexadecimal number. The number of times received is cleared each time the result is read.

Response Codes

Response code	Description
0000	Normal
1001	Command too large

7-2-7 BROADCAST DATA SEND

Sends test data simultaneously to all nodes on the network.

Command Block

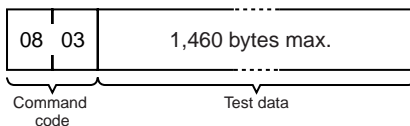

Parameters

Test Data (Command)

This command specifies the data to be sent to the specified nodes. Up to 1,460 bytes can be specified.

Precautions

No response is made to this command.

When using this command, set the FINS header parameters (or the control data for the CMND(194) instruction) as follows:

- Destination node address: FF (broadcast data)
- Destination unit address: FE (Ethernet Unit)
- Response/no response flag: 1 (no response)

7-2-8 ERROR LOG READ

Reads the error log.

Command Block

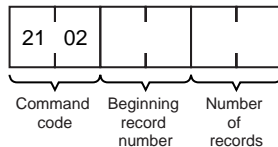

Response Block

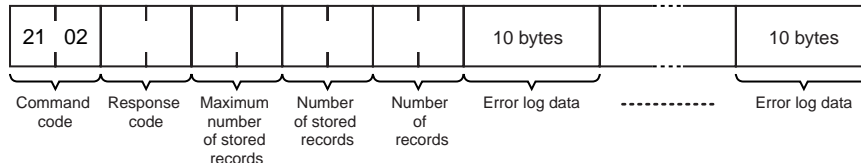

Parameters

Beginning Record Number (Command)

The first record to be read. The first record number can be specified in the range between 0000 and 003F (0 to 63 decimal) where 0000 is the oldest record.

Number of Records (Command, Response)

The number of records to read is specified between 0001 and 0040 (1 to 64 decimal) in the command. The response returns the actual number of records read.

Maximum Number of Stored Records (Response)

The maximum number of records that can be stored in the error log. Care is required as the error log differs according to the type of PC or CPU Bus Unit. In an Ethernet Unit, the maximum number of stored records is fixed at 40 (64 decimal).

Number of Stored Records (Response)

The number of records stored at the time the command is executed is returned.

Error Log Data (Response)

The specified number of error log records from the beginning record number is returned sequentially. The total number of bytes in the error log is calculated as the number of records x 10 bytes/record. Each error log record thus comprises 10 bytes, configured as follows:

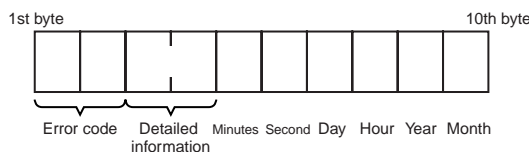

Error Code, Detailed Information

Details of the error stored in the record. Refer to 8-5 *Troubleshooting with Response Codes* for details.

Minute, Second, Day, Hour, Year, Month

Indicate the time at which the error stored in the record occurred.

Precautions

If the error log contains fewer records than the number specified in the number of records parameter, all records stored in the error log at the time the command is executed will be returned and the command executed will end normally.

Response Codes

Response code	Description
0000	Normal
1001	Command too large
1002	Command too small
1103	Beginning record number is out of range
110C	The number of read records is 0.

7-2-9 ERROR LOG CLEAR

Clears the number of records stored in the Ethernet Unit error log.

Command Block

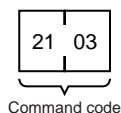

Response Block

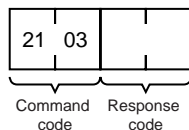

Response Codes

Response code	Description
0000	Normal
1001	Command too large

7-2-10 PING

Equivalent processing to the UNIX computer PING command (see below).

Command Block

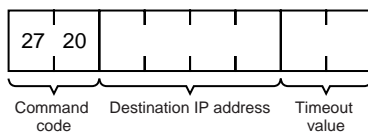

Response Block

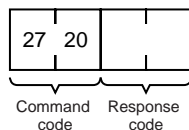

Parameters

Destination IP Address (Command)

The IP address (in hexadecimal) of the destination node for the PING command echo request packet.

Timeout Value (Command) The wait time for the echo reply packet. The value is set in seconds. The timeout time is set at 20 seconds if the value is specified as 0. If the echo reply packet is not received within the set time limit, the code for a timeout error will be set as the results storage response code.

Remarks

PING Command

The PING command runs the echoback test using the ICMP protocol. When the PING command is executed, an echo request packet is sent to the remote node ICMP. Correct communications are confirmed when the returned response packet is received normally. The echo reply packet is automatically returned by the remote node ICMP.

Response Codes

Response code	Description
0000	Normal
0205	Timeout error
1001	Command too large
1002	Command too small
1100	Zero destination address
220F	PING command currently being executed
2211	High traffic at Unit; cannot execute service.

7-2-11 FINS/TCP CONNECTION REMOTE NODE CHANGE REQUEST

Requests a remote node change for the FINS/TCP connection.

The default destination IP address in a connection in which the Ethernet Unit is used as a client is the destination IP address set under the FINS/TCP Tab in the Unit Setup. By sending this command to the Ethernet Unit, the destination IP address for the specified connection can be changed to another IP address.

Note Remote node changes can be made only for connection numbers specified as FINS/TCP clients in the Unit Setup.

Command Block

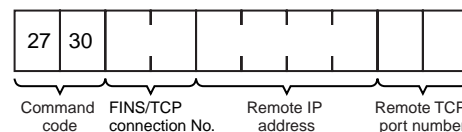

Response Block

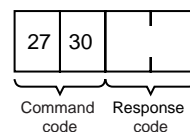

Parameters

FINS/TCP Connection No. (Command) Specifies, in two bytes, the FINS/TCP connection number (1 to 16) for which the change is to be made.

Remote IP Address (Command) Specifies the remote node's IP address (must be non-zero) in hexadecimal.

Remote Port Number (Command)

Specifies the remote TCP port number (must be non-zero) with this command.

Response Codes

Response code	Description
0000	Normal
0105	Node address setting error Local IP address setting error
0302	CPU Unit error; execution not possible.
1001	Command too large
1002	Command too small
1100	Connection number not set from 1 to 16 Remote IP address set to 0 Remote TCP port number set to 0
2230	Connection already established with specified remote node
2231	Specified connection number not set as FINS/TCP client in Unit Setup
2232	Remote node change processing for specified connection number aborted because change request received during processing

7-2-12 FINS/TCP CONNECTION STATUS READ

Reads the FINS/TCP connection status.

Command Block

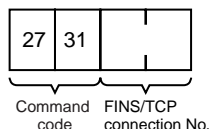

Response Block

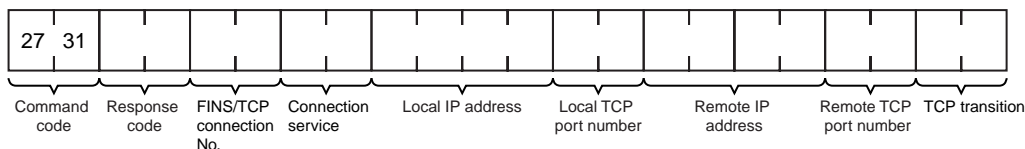

Parameters

FIFINS/TCP Connection No. (Command, Response)

Command: Specifies, in two bytes, the FINS/TCP connection number (1 to 16) for which the status is to be read.

Response: Specifies the FINS/TCP connection number (1 to 16) for which the status was read.

Connection Service (Response)

Specifies the service that is being used for the FINS/TCP connection as a number.

0003: FINS/TCP server

0004: FINS/TCP client

Local IP Address (Response)

Specifies the IP address for the local node in hexadecimal.

Local TCP Port Number (Response)

Specifies the TCP port number for the local node.

Remote IP Address (Response)

Specifies the IP address for the remote node in hexadecimal.

Remote TCP Port Number (Response)

Specifies the TCP port number for the remote node.

TCP Transitions (Response)

Specifies the TCP connection status using the following numbers. For details on TCP status changes, refer to *Appendix C TCP Status Transitions*.

Number	Status	Meaning
00000000	CLOSED	Connection closed.
00000001	LISTEN	Waiting for connection.
00000002	SYN SENT	SYN sent in active status.
00000003	SYN RECEIVED	SYN received and sent.
00000004	ESTABLISHED	Already established.
00000005	CLOSE WAIT	FIN received and waiting for completion.
00000006	FIN WAIT 1	Completed and FIN sent.
00000007	CLOSING	Completed and exchanged FIN. Awaiting ACK.
00000008	LAST ACK	FIN sent and completed. Awaiting ACK.
00000009	FIN WAIT 2	Completed and ACK received. Awaiting FIN.
0000000A	TIME WAIT	After closing, pauses twice the maximum segment life (2MSL).

Response Codes

Response code	Description
0000	Normal
0105	Node address setting error Local IP address setting error
0302	CPU Unit error; execution not possible.
1001	Command too large
1002	Command too small
1100	Connection number not set from 1 to 16

7-2-13 IP ADDRESS TABLE WRITE

Writes the IP address table.

Command Block

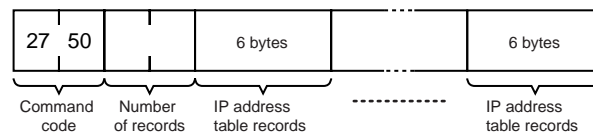

Response Block

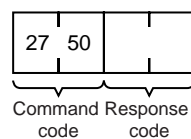

Parameters

Number of Records (Command)

The number of records to write is specified in hexadecimal between 0000 and 0020 (0 to 32 decimal) in the command. If this value is set to 0, the IP address table will be cleared so that no records are registered.

IP Address Table Records (Command)

Specify the IP address table records. The number of records specified must be provided. The total number of bytes in the IP address table records is calculated as the number of records × 6 bytes/record. The configuration of the 6 bytes of data in each record is as shown in the following diagram.

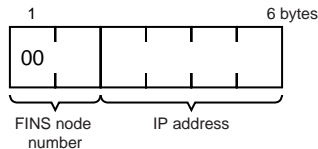

FINS Node Address

Node address for communications via the FINS command (hexadecimal).

IP Address

IP address used by TCP/IP protocol (hexadecimal).

Precautions

The new I/O address table records will not be effective until the PC is restarted or the Ethernet Unit is reset.

An error response will be returned if the IP address conversion method in the system mode settings is set for automatic generation.

Response Codes

Response code	Description
0000	Normal (echo reply received from the remote node)
1001	Command too large
1002	Command too small
1003	The number of records specified does not match the sent data length.
110C	The number of records is not between 0 and 32. The FINS node address is not between 1 and 126 The IP address is 0.
2307	IP address conversion method is set for automatic generation.

7-2-14 IP ADDRESS WRITE

Write the local IP address and the subnet mask in the CPU Bus Unit System Setup.

Command Block

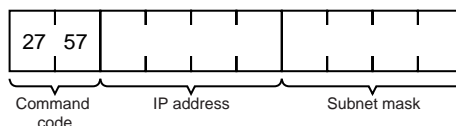

Response Block

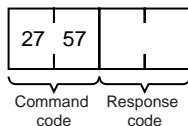

Parameters

IP Address (Command)

Specify the local IP address of the Ethernet Unit using 4 pairs of hexadecimal numbers in the range 00.00.00.00 to FF.FF.FF.FF (0.0.0.0. to 255.255.255.255 decimal). If 0.0.0.0 is specified, the local IP address set in the allocated words in the DM Area is enabled.

Example: 150.31.2.83

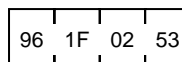

Subnet Mask (Command)

Specify the local IP address of the Ethernet Unit using 4 pairs of hexadecimal numbers in the range 00.00.00.00 to FF.FF.FF.FF (0.0.0.0. to 255.255.255.255 decimal).

Example: 255.255.255.255

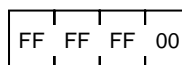

Response Codes

Response code	Description
0000	Normal
1001	Command too large
1002	Command too small

Precautions

The local IP address and subnet mask set using this mask are written to the CPU Bus Unit System Setup for the Ethernet Unit.

The new local IP address and subnet mask settings will not be effective until the PC is restarted or the Ethernet Unit is reset.

7-2-15 IP ADDRESS TABLE READ

Reads the IP address table.

Command Block

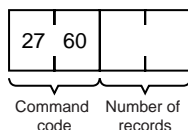

Response Block

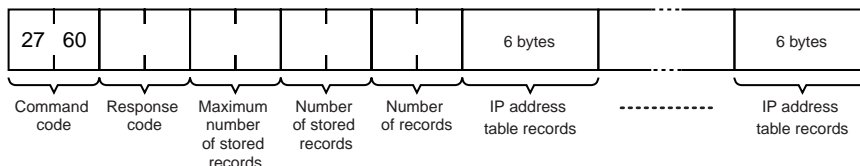

Parameters

Number of Records (Command, Response)

The number of records to read is specified between 0000 and 0020 (0 to 32 decimal) in the command. If this value is set to 0, the number of stored records is returned but the IP address table records are not returned. The response returns the actual number of records read.

Maximum Number of Stored Records (Response)

The maximum number of records that can be stored in the IP address table is returned. The maximum number of stored records is fixed at 0020 (32 records).

Number of Stored Records (Response)

The number of IP address table records stored at the time the command is executed is returned as a hexadecimal number.

IP Address Table Records (Response)

The number of IP address table records specified in the number of records parameter is returned. The total number of bytes in the IP address table records is calculated as the number of records \times 6 bytes/record. The configuration of the 6 bytes of data in each record is as shown in the following diagram.

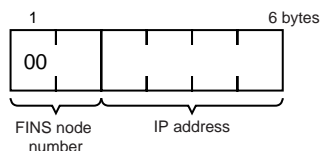

FINS Node Address

Node address for communications via the FINS command (in hexadecimal).

IP Address

IP number used by TCP/IP protocol (in hexadecimal).

Precautions

If the IP address table contains fewer records than the number specified in the *number of records* parameter, all the records contained in the IP address table when the command is executed will be returned and the command execution will end normally.

An error response will be returned if the IP address conversion method in the system mode settings is set to the automatic generation method.

Response Codes

Response code	Description
0000	Normal
1001	Command too large
1002	Command too small
2307	IP address conversion method is set to the automatic generation method.

7-2-16 IP ROUTER TABLE READ

Reads the IP router table.

Command Block

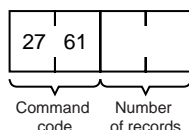

Response Block

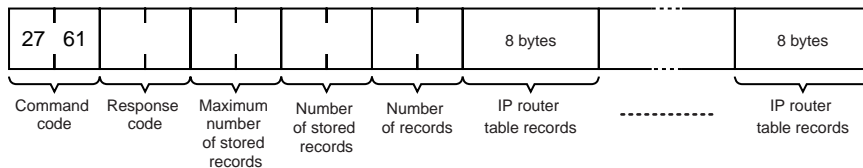

Parameters

Number of Records (Command, Response)

The number of records to read is specified between 0000 and 0008 (0 to 8 decimal) in the command. If this value is set to 0, the number of stored records will be returned but the IP router table records will not be returned. The response returns the actual number of records read.

Maximum Number of Stored Records (Response)

The maximum number of records that can be stored in the IP router table is returned. The maximum number of stored records is fixed at 0008 (8 records).

Number of Stored Records (Response)

The number of IP router table records stored at the time the command is executed is returned in hexadecimal.

IP Router table Records (Response)

The number of IP router table records specified in the *number of records* parameter is returned. The total number of bytes in the IP router table records is calculated as the number of records × 8 bytes/record. The configuration of the 8 bytes of data in each record is shown below.

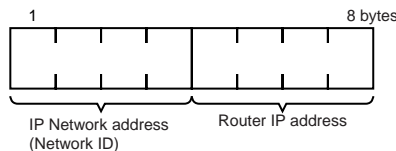

IP Network Address

The network ID from the IP address in hexadecimal. The network ID part corresponding to the address class (determined by the leftmost 3 bits) set here, is enabled. (Refer to page 13.)

Router IP Address

The IP address (in hexadecimal) of a router connected to a network specified with IP addresses.

Precautions

If the IP router table contains fewer records than the number specified in the *number of records* parameter, all the records contained in the IP router table when the command is executed will be returned and the command execution will end normally.

Response Codes

Response code	Description
0000	Normal
1001	Command too large
1002	Command too small

7-2-17 PROTOCOL STATUS READ

Reads the Ethernet Unit protocol status.

Command Block

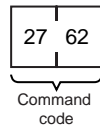

Response Block

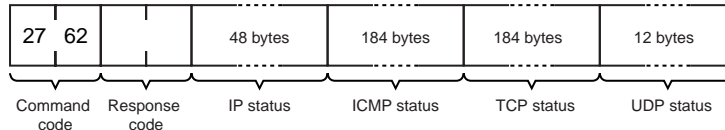

Parameters

IP Status (Response)

Twelve types of IP status information occupying 4 bytes each are returned in the following sequence. Each value is returned as an 8-digit hexadecimal value.

- 1,2,3...**
1. Total number of IP packets received.
 2. The number of IP packets discarded due to an error with the checksum in the packet header.
 3. The number of IP packets discarded because the received packet was larger than the overall packet length value in the packet header.
 4. The number of IP packets discarded because the minimum size of the IP header data could not be stored in the first short buffer (See note.) when an attempt was made to store the packet.
 5. The number of packets discarded for one of the following reasons:
 - The IP header length value in the IP header was smaller than the smallest size of the IP header.
 - The size of the first short buffer (See note.) was smaller than the IP header length value in the IP header when storing the packet.
 6. The number of IP packets discarded because the IP header length was larger than the overall packet length value in the packet header.
 7. The number of fragmented packets received.
 8. The number of received fragmented IP packets discarded because a queue for reassembly could not be secured.
 9. The number of fragmented IP packets discarded because they could not be reassembled within 12 seconds after being received.
 10. Always 0.
 11. The number of packets addressed to other networks that have been discarded.
 12. Always 0.

Note Refer to 7-2-18 *MEMORY STATUS READ* for details on the short buffer.

ICMP Status (Response)

Ten types (46 items) of ICMP status information occupying 4 bytes each are returned in the following sequence. Each value is returned as an 8-digit hexadecimal value.

1,2,3...

1. The number of times the ICMP error routine was called. The ICMP error routine uses ICMP packets to inform the source about errors. The routine is called when an illegal packet is received (error in IP option processing or error in relay processing) or if the object port does not exist when using UDP.
2. Always 0.
3. Always 0.
4. Total number of outputs of each packet type during ICMP output. The 19 statistical values are returned in the order shown below. Contents are defined for 13 types only; all other types contain 0. Only #0, #3, #14, #16, and #18 are counted by the Ethernet Unit.

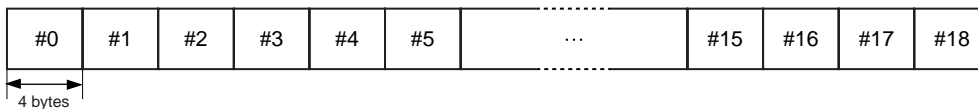

Type number	Description
#0	Echo reply
#1, #2	Undefined, always 0
#3	Destination unreachable
#4	Source quench
#5	Routing redirect
#6, #7	Undefined, always 0
#8	Echo
#9, #10	Undefined, always 0
#11	Time exceeded
#12	Parameter problem
#13	Time stamp
#14	Time stamp reply
#15	Information request
#16	Information request reply
#17	Address mask request
#18	Address mask reply

5. The number of received ICMP packets discarded because the type-indication code was out of range.
6. The number of received ICMP packets discarded because the overall packet length value in the packet header was smaller than the minimum ICMP packet length.
7. The number of received ICMP packets discarded because of an incorrect checksum value in the packet header.
8. The number of received ICMP packets discarded because the ICMP header length value in the packet header did not match the lengths of individual header types.
9. The number of responses returned to received ICMP packets requiring a response.
10. Total number of inputs of each packet type during ICMP input. The 19 statistical values are returned in the order shown below. Contents are defined for 13 types only; all other types contain 0.

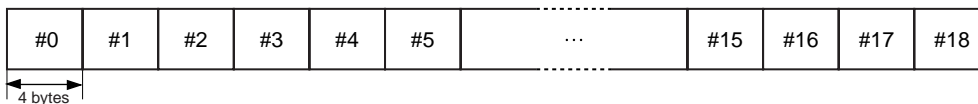

Type number	Description
#0	Echo reply
#1, #2	Undefined, always 0
#3	Destination unreachable
#4	Source quench
#5	Routing redirect
#6, #7	Undefined, always 0
#8	Echo
#9, #10	Undefined, always 0
#11	Time exceeded
#12	Parameter problem
#13	Time stamp
#14	Time stamp reply
#15	Information request
#16	Information request reply
#17	Address mask request
#18	Address mask reply

TCP Status (Response)

Three types (46 items) of TCP status information occupying 4 bytes each are returned in the following sequence. Each value is returned as an 8-digit hexadecimal value.

1) Connection Information (60 Bytes)

Fifteen items are returned in the following sequence:

1,2,3...

1. The number of times active connections were correctly established.
2. The number of times a SYN packet was received while waiting to establish a passive connection.
3. The number of times active or passive connections were correctly established.
4. The number of times an established connection was cut off.
5. The number of times the connection wait status was cut off.
6. The number of times protocol control blocks or other actively allocated structures were released.
7. The number of segments for the round-trip time (time from segment transmission to ACK).
8. The number of times the round-trip time was changed.
9. The number of times a delayed acknowledgement (ACK) was sent. If the order of the received segments is reversed, ACK is sent with a packet of data separate from ACK (response to input data, etc.) or is immediately sent with the ACK for other data.
10. The number of times the connection was cut off because no ACK was returned after several resend attempts.
11. The number of times no ACK was returned within the resend timer set time. (The resend timer sets the maximum time limit between the data being output and ACK being returned.)

12. The number of times no window advertisement is received within the time set on the duration timer. (The duration timer sets the maximum time limit for a window advertisement to be received if the transmission window is smaller than necessary and the resend timer is not set. If no window advertisement is received within the time limit, the number of segments permitted by the transmission window are sent. If the transmission window is set to 0, a window probe (1 octet of data) is sent before the timer restarts.)
13. The number of times no segment was sent or received within the time set on the hold timer.
14. The number of times the hold packet is resent. (Always 0.)
15. The number of times the hold packet is sent without response before the connection is cut off.

2) Send Information (40 Bytes)

Ten information items are returned in the following sequence:

- 1,2,3...
1. The total number of packets sent.
 2. The number of data packets sent.
 3. The number of data bytes sent.
 4. The number of data packets resent.
 5. The number of data bytes resent.
 6. The number of ACK packets sent.
 7. The number of window probes (1 octet of data) sent.
 8. The number of emergency data packets sent. (Always 0.)
 9. The number of window advertisement packets sent.
 10. The number of control packets (SYN, FIN, RST) sent.

3) Receive Information

Twenty-one information items are returned in the following sequence:

- 1,2,3...
1. The total number of packets received.
 2. The number of packets received continuously.
 3. The number of bytes received continuously.
 4. The number of received packets discarded due to an incorrect checksum.
 5. The number of packets discarded because the TCP header was smaller than the minimum size for a TCP header or was larger than the IP packet.
 6. The number of packets discarded because the TCP header and IP header could not be stored in the first short buffer.
 7. The number of resent packets received.
 8. The number of bytes in the resend packets.
 9. The number of duplicated resend packets received.
 10. The number of bytes in the duplicated resend packets received.
 11. The number of out-of-range data packets received. (Always 0.)
 12. The number of bytes in the out-of-range data packets received. (Always 0.)
 13. The number of packets where the data was larger than the window.
 14. The number of bytes in the packets where the data was larger than the window.
 15. The number of packets received after closing.
 16. The number of window probe packets received.
 17. The number of resent ACK packets received.

- 18. The number of ACK packets received with no data set.
- 19. The number of ACK packets received.
- 20. The number of ACK packets received for received transmission acknowledgements (ACK).
- 21. The number of window advertisement packets received.

UDP Status (Response)

Three items of UDP information occupying 4 bytes each are returned in the following sequence. Each value is returned as an 8-digit hexadecimal value.

1,2,3...

- 1. The number of packets discarded because the size of the first short buffer was smaller than the minimum size (28) of the IP header and UDP header when the packet was stored.
- 2. The number of packets discarded due to an incorrect checksum in the UDP header.
- 3. The number of packets discarded because the IP overall length in the IP header was shorter than the UDP overall length in the UDP header.

Precautions

All the above values are set to 0 if network operation stops due to incorrect settings in the system setup.

Counting will be stopped when a count reaches the maximum value. The maximum values are as follows:

IP, ICMP, or UDP status: 7FFFFFFF (2,147,483,647 decimal)
 TC status: FFFFFFFF (4,294,967,295 decimal)

Response Codes

Response code	Description
0000	Normal
1001	Command too large

7-2-18 MEMORY STATUS READ

Reads the status of the Ethernet Unit's network memory. The network memory contains 248K bytes that are used as required as for communications buffers for communications servicing. The network memory consists of 1,472 short buffers (128 bytes each) and 64 long buffers (1,024 bytes each). Refer to *Appendix B Buffer Configuration*.

Command Block



Response Block

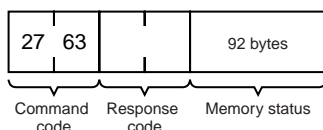

Parameters

Memory Status (Response)

A total of 23 data items in six areas are returned in the following order. Each item consists of 4 bytes.

- 1,2,3...**
1. Short Buffer Application: Two items are returned (8 bytes).
 - a. The number of short buffers currently being used.
 - b. The number of short buffers in the system (fixed at 1,472 decimal).
 2. Short Buffer Application by Type: Thirteen items are returned (52 bytes).
 - a. The number of short buffers used for storing communications data.
 - b. The number of short buffers used for protocol headers (TCP, UDP, IP, ICMP, ARP)
 - c. The number of short buffers used in socket structures
 - d. The number of short buffers used as protocol control blocks
 - e. The number of short buffers used for routing tables
 - f. Not used (always 0)
 - g. Not used (always 0)
 - h. The number of short buffers used for IP fragment re-assembly queue headers
 - i. The number of short buffers used for storing socket addresses
 - j. Not used (always 0)
 - k. The number of short buffers used for storing socket options
 - l. The number of short buffers used for storing access rights
 - m. The number of short buffers used for storing interface addresses
 3. Long Buffer Application: Two items are returned (8 bytes).
 - a. The number of long buffers currently being used.
 - b. The number of long buffers in the system (fixed at 64 decimal).
 4. Not Used: Always 0. (4 bytes)
 5. Network Memory Application: Two items are returned(8 bytes).
 - a. The number of bytes used (in K bytes)
 - b. The percentage used.
 6. Memory Exhaustion Log (12 bytes)

Counts for the following values indicate a high load on the Ethernet Unit. These high loads may be caused by problems in communications, particularly FINS communications and UDP sockets. If these values are consistently high, check your applications.

 - a. The number of times an attempt was made to secure a short buffer without WAIT when there were no short buffers available.
 - b. The number of times an attempt was made to secure a short buffer with WAIT when there were no short buffers available.
 - c. The number of times an attempt was made to release and secure a short buffer already being used by another socket when there were no short buffers available.

Precautions

All the above values are set to 0 if Ethernet communications functions are stopped due to improper settings in the system setup.

These values are cleared when the Ethernet Unit is started or reset. Values will be counted only until the maximum values are reached.

Response Codes

Response code	Description
0000	Normal
1001	Command too large

7-2-19 SOCKET STATUS READ

Reads the Ethernet Unit network socket status.

Command Block

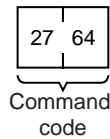

Response Block

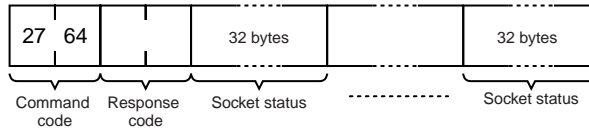

Parameters

Socket Status (Response)

Returns eight types of information in records of 32 bytes each. A maximum of 62 records can be returned. The format of each record is shown below.

Protocol (4 bytes)

The protocol used for the socket is returned as a number.
00 00 00 06: TCP; 00 00 00 11: UDP

Receive Queue (4 bytes)

The number of bytes in the reception queue.

Send Queue (4 bytes)

The number of bytes in the send queue.

Local IP Address (4 bytes)

The local IP address allocated to the socket.

Local Port Number (4 bytes)

The local port number allocated to the socket.

Remote IP Address (4 bytes)

The remote IP address allocated to the socket.

Remote Port Number (4 bytes)

The remote port number allocated to the socket.

TCP Transitions (4 bytes)

The TCP connection status is returned as one of the numbers shown in the following table. Refer to *Appendix C TCP Status Transitions* for a diagram of transitions.

Number	Stage	Status
00 00 00 00	CLOSED	Closed.
00 00 00 01	LISTEN	Waiting for connection.
00 00 00 02	SYN SENT	SYN sent in active status.
00 00 00 03	SYN RECEIVED	SYN received and sent.
00 00 00 04	ESTABLISHED	Already established.
00 00 00 05	CLOSE WAIT	Received FIN, waiting to close.
00 00 00 06	FIN WAIT 1	Completed and FIN sent.
00 00 00 07	CLOSING	Completed and exchanged FIN. Awaiting ACK.
00 00 00 08	LAST ACK	FIN sent and completed. Awaiting ACK.
00 00 00 09	FIN WAIT 2	Close completed and ACK received. Awaiting FIN.
00 00 00 0A	TIME WAIT	After closing, pauses twice the maximum segment life (2MSL).

Precautions

All the above values are set to 0 if Ethernet communications functions are stopped due to improper settings in the system setup.

Response Codes

Response code	Description
0000	Normal
1001	Command too large

7-2-20 ADDRESS INFORMATION READ

Reads FINS node addresses and IP addresses

Command Block

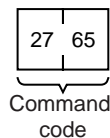

Response Block

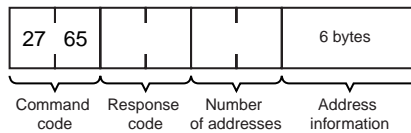

Parameters

Number of Addresses (Response)

The number of pairs of FINS node addresses and IP addresses being returned. The Ethernet Unit is always 0001 (1 decimal).

Address Information (Response)

Pairs of FINS node addresses and IP addresses. Each pair requires 6 bytes and has the following configuration.

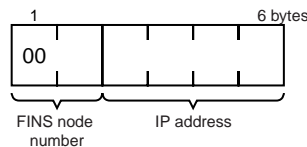

FINS Node Address

Node address set on the Ethernet Unit (hexadecimal).

IP Address

IP address set on the Ethernet Unit (hexadecimal).

Response Codes

Response code	Description
0000	Normal
1001	Command too large

7-2-21 IP ADDRESS READ

Reads the local IP address and subnet mask in the CPU Bus Unit System Setup and the FINS node address. The values read with this command, however, are not necessarily the settings actually used for operation. The settings that are actually used for operation can be confirmed using CONTROLLER DATA READ (page 136) and ADDRESS INFORMATION READ (page 158).

Command Block

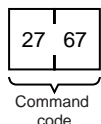

Response Block

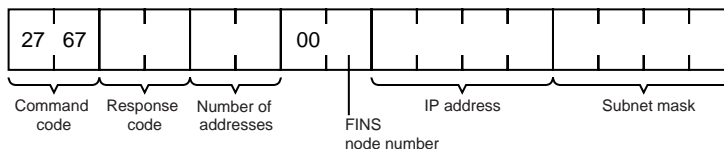

Parameters

Number of Addresses (Response)

The number of sets of FINS node addresses, IP addresses, and subnet masks being returned. The Ethernet Unit is always 0001 (1 decimal).

FINS Node Address (Response)

Node address set on the Ethernet Unit (hexadecimal).

IP Address (Response)

The local IP address set in the CPU Bus Unit System Setup for the Ethernet Unit is returned in order starting from the leftmost bytes in hexadecimal. If the local IP address set in the allocated words in the DM Area is enabled, 0.0.0.0 is returned.

Subnet Mask (Response)

The subnet mask set in the CPU Bus Unit System Setup for the Ethernet Unit is returned in order starting from the leftmost bytes in hexadecimal.

Response Codes

Response code	Description
0000	Normal
1001	Command too large

SECTION 8

Troubleshooting

This section describes information and procedures that can be used to troubleshoot problems that sometimes occur with Ethernet Unit and Ethernet communications.

The Ethernet Unit makes up part of a network. Repair a defective Ethernet Unit as soon as possible as it can have a negative effect on the entire network. We recommend that customers keep one or more spare Ethernet Units to allow immediate recovery of the network.

8-1	Troubleshooting with Indicators	162
8-2	Error Status	163
8-3	Error Log.	164
8-3-1	Error Log Error Codes	165
8-4	Troubleshooting Procedures	171
8-4-1	Startup Problems.	171
8-4-2	FINS Communications Problems (SEND(090)/RECV(098)/CMND(490))	172
8-4-3	Network Connection Problems.	173
8-5	Troubleshooting with Response Codes	174

8-1 Troubleshooting with Indicators

The indicators on the Ethernet Unit can be used to troubleshoot some error. The probable cause and correction for errors that can be determined from the LINK, HOST, RUN, ERC, and ERH indicators are listed in the following table.

RUN	ERC	ERH	LNK	Probably cause	Correction
Not lit	Not lit	Not lit	---	Power is not being supplied to the CPU Unit or the power supply voltage is too low.	Supply power. Make sure that the correct voltage is being supplied.
				The Ethernet Unit is faulty.	Replace the Ethernet Unit.
				The CPU Unit or Backplane is faulty.	Replace the CPU Unit or the Backplane.
				The mounting screws on the Ethernet Unit are loose.	Tighten the mounting screws to the specified torque.
Not lit	Lit	Not lit	---	The node address is set outside the correct range on the rotary switches.	Set the node address to between 01 and FE Hex.
				The Ethernet Unit is faulty.	Restart the PLC. If the problem persists, replace the Ethernet Unit.
Not lit	Not lit	Lit	---	The unit number on the Ethernet Unit is not set correctly on the rotary switch.	Correct the unit number setting.
				The I/O tables are not registered in the CPU Unit.	Register the I/O tables.
				The same unit number is being used on another Unit as well.	Correct the unit number.
				The CPU Unit is faulty.	Restart the CPU Unit. If the problem persists, replace the CPU Unit.
Lit	---	---	Not lit	There is no communications link with the hub.	If power is not turned ON to the hub, turn it ON. If there is crossed cable between the Ethernet Unit and the hub, use straight cable.
Lit	---	Lit	---	There is a mistake in the Unit Setup or routing tables.	Read the error history and correct the data that is causing the error. If the problem persists, replace the CPU Unit.
				Memory in the CPU Unit is faulty.	Restart the CPU Unit. If the problem persists, replace the CPU Unit.
				The CPU Unit is faulty.	Restart the CPU Unit. If the problem persists, replace the CPU Unit.
				There is a mistake in the settings for a server (DNS, SMTP, POP3, or SNMP) in the Unit Setup.	Read the error status and history and correct the data that is causing the error. If the problem persists, replace the CPU Unit.
Lit	Lit	---	---	An error occurred in EEPROM.	Restart the PLC. If the problem persists, replace the Ethernet Unit.

RUN	ERC	ERH	LNK	Probably cause	Correction
Lit	---	Flashing	---	The IP address is set incorrectly.	Correct the IP address. Do not set any of the following IP addresses. <ul style="list-style-type: none"> • Host IDs that are all 0 or all 1. • Network IDs that are all 0 or all 1. • Subnetwork IDs that are all 1. • Addresses beginning with 127 (7F Hex).
				The node address set on the rotary switch on the front of the Unit does not agree with the host ID in the IP address. This probably can occur when the address conversion method is set for automatic address generation.	Make sure that the node address and the last byte of the IP address are the same and set other host IDs to 0. Change the address conversion method.
				An access error occurred when setting the Unit using a text file on a Memory Card.	Check the error code, remove the cause of the error, and then set the Unit. The error can be cleared by setting the Unit correctly or by turning ON the Memory Card Unit Setup Error Clear Bit.

8-2 Error Status

The Ethernet Unit will output error status to the following word in the CIO Area of the CPU Unit. This information can be used in troubleshooting errors.

$$\text{Word} = \text{CIO } 1500 + (25 \times \text{unit number}) + 18$$

Error Status (Ethernet Unit to CPU Unit)

The status of errors that occur at the Ethernet Unit is reflected as shown in the following diagram.

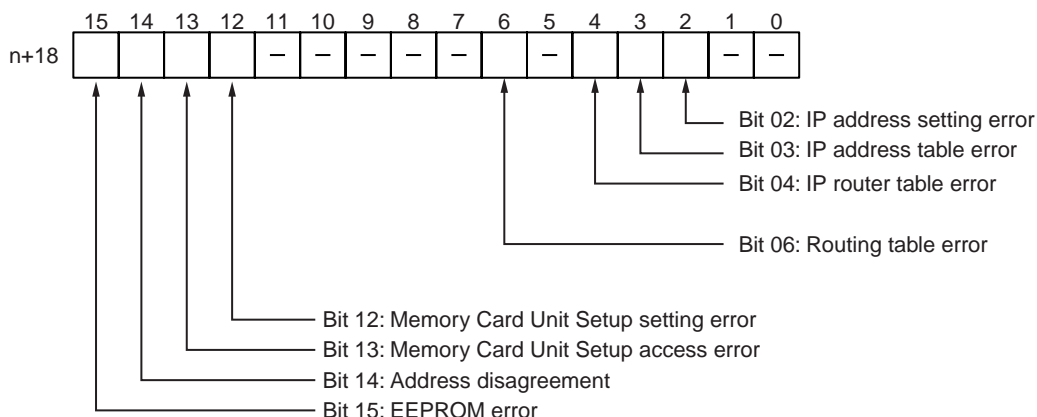

Bit	Error	Status	Manipulated by	Unit operation
0 to 1	(Not used.)	---	---	---
2	IP address setting error	ON	Unit	ON if any of the following conditions apply to the IP address. <ul style="list-style-type: none"> • All bits in the host ID are 0 or 1. • All bits in the network ID are 0 or 1. • All bits in the subnet ID are 1. • The IP address begins with 127 (0x7F)
		OFF	Unit	OFF when the IP address is normal.
3	IP address table error	ON	Unit	ON if the IP address table information is incorrect.
		OFF	Unit	OFF when the IP address table is normal.
4	IP router table error	ON	Unit	ON if the IP router table information is incorrect.
		OFF	Unit	OFF when the IP address table is normal.

Bit	Error	Status	Manipulated by	Unit operation
5	(Not Used.)			
6	Routing table error	ON	Unit	ON if the routing table information is incorrect.
		OFF	Unit	OFF when the routing table is normal.
7 to 11	(Not used.)	---	---	---
12	Memory Card Unit Setup setting error	ON	Unit	ON if there is an error in the setup file on the Memory Card.
		OFF	Unit	OFF when the Unit is set correctly or when the Memory Card Unit Setup Error Clear Bit is turned ON.
13	Memory Card Unit Setup access error	ON	Unit	ON if there is an access error when setting the Unit using a text file on a Memory Card. When this bit turns ON, an error code will be stored in the Memory Card Unit Setup Error Code storage word.
		OFF	Unit	OFF when the Unit is set correctly or when the Memory Card Unit Setup Error Clear Bit is turned ON.
14	Address disagreement	ON	Unit	ON if the remote IP address is set to automatic generation but the local IP address host number and FINS node address do not agree.
		OFF	Unit	OFF under all other circumstances.
15	EEPROM error	ON	Unit	ON if an error has occurred in the EEPROM memory.
		OFF	Unit	OFF when the EEPROM memory is normal.

8-3 Error Log

The Ethernet Unit provides an error log that records errors that have occurred during Ethernet Unit operation. The contents of the error log can be read or cleared from a Programming Device, such as the CX-Programmer, or it can be read or cleared using FINS commands from a workstation or computer. (See 7-2-8 *ERROR LOG READ* and 7-2-9 *ERROR LOG CLEAR*).

Logged Errors

The following errors are recorded in the error log.

- Errors in network operation
- Errors in data transfers
- Error in the CPU Unit

Error Log Table

Each error is recorded as one record in an error log table. Up to 64 records can be saved. If more than 64 errors occur, the oldest errors will be deleted from the error log and the most recent error will be recorded.

The following information is recorded in the error log table.

- Main error code (See table later in this section.)
- Detailed error code (See table later in this section.)
- Time stamp (from the clock in the CPU Unit)

Error Log Location

When an error is detected, the error codes and time stamp are recorded in the error log in RAM inside the Ethernet Unit. Serious errors are also recorded in EEPROM. The maximum number of errors that can be saved to EEPROM is 64 for the CS Series. The errors recorded in EEPROM will be saved even if the Unit is restarted or power is turned OFF. When the Ethernet Unit is started, the contents of the error log in EEPROM is copied to RAM.

When a FINS command is used to read the error log, the log held in RAM is read. When a FINS command is used to clear the error log, the logs held in both RAM and EEPROM are cleared.

FINS Commands for Error Logs

The following FINS commands can be used to read or clear the error log. Refer to *SECTION 7 FINS Commands Addressed to Ethernet Units*.

Command code		Function
MRC	SRC	
21	02	ERROR LOG READ
	03	ERROR LOG CLEAR

8-3-1 Error Log Error Codes

The error codes are described in the following table. The detailed error code will provide detailed information on an error.

Error code	Meaning	Detailed error code		Correction	EE-PROM
		1st byte	2nd byte		
0001	Watchdog timer error in CPU Unit	00	00	Replace the CPU Unit.	Saved
0002	CPU Unit service monitor error	Monitor time (ms)		Check the operating environment.	Saved
0006	Other CPU error	Bit 11: Unit not in Registered I/O Tables Other bits are reserved for system use.		Create the I/O tables.	Saved
000F	CPU Unit initialization error	00	00	Replace the CPU Unit.	Saved
0010	Insufficient System Setup Area	00	00	Reduce the number of CPU Bus Units.	Saved
0011	Event timed out	MRC	SRC	Replace the CPU Unit.	Saved
0012	CPU Unit memory error	01: Read error 02: Write error	03: Routing table 04: Setup error 05: CPU Bus Unit Words (CIO/DM)	01: Recreate the data specified by the 2nd byte of the detailed error code. 02: Clear memory using procedure in the PLC operation manual.	Saved
0013	CPU Unit protected	00	00	Remove protection from CPU Unit memory.	Saved

Error code	Meaning	Detailed error code		Correction	EE-PROM
		1st byte	2nd byte		
0103	Resend count exceeded (send failed)	Commands Bit 15: OFF Bits 08 to 14: SNA Bits 00 to 07: SA1 Responses Bit 15: ON Bits 08 to 14: DNA Bits 00 to 07: DA1		Check transceiver at remote node.	---
0105	Node address setting error (send failed)			Set the IP address correctly.	---
0107	Remote node not in network (send failed)			Check the connection to the remote node.	---
0108	No Unit with specified unit address (send failed)			Check the unit address at the remote node.	---
010B	CPU Unit error (send failed)			Troubleshoot the error in the CPU Unit using the PLC operation manual.	---
010D	Destination address not in routing tables (send failed)			Set the destination address in the routing tables.	---
010E	No routing table entry (send failed)			Set the local node, remote node, and relay nodes in the routing tables.	---
010F	Routing table error (send failed)			Create the routing tables correctly.	---
0110	Too many relay points (send failed)			Reconstruct the network or correct the routing tables so that commands are sent to within a 3-level network range.	---
0111	Command too long (send failed)			Check the command format and set the correct command data.	---
0112	Header error (send failed)			Check the command format and set the correct command data.	---
0117	Internal buffers full; packet discarded			Change the network so that traffic is not concentrated.	---
0118	Illegal packet discarded			Check for nodes sending illegal packets.	---
0119	Local node busy (send failed)			Change the network so that traffic is not concentrated.	---
0120	Unexpected routing error			Check the routing tables.	---
0121	No setting in IP address table; packet discarded			Set the remote node in the IP address table.	---
0122	Service not supported in current mode; packet discarded	Select the IP address table or both methods for the address conversion method.	---		
0123	Internal send buffer full; packet discarded	Change the network so that traffic is not concentrated.	---		
0124	Maximum frame size exceeded; routing failed	Reduce the size of events.	---		
021A	Logic error in setting table	00	01: Data link table 02: Network parameters 03: Routing tables 04: Unit Setup 05: CPU Bus Unit Words (CIO/DM)	Recreate the data specified by the 2nd byte of the detailed error code.	Saved

Error code	Meaning	Detailed error code		Correction	EE-PROM
		1st byte	2nd byte		
0300	Parameter error; packet discarded	Commands Bit 15: OFF Bits 08 to 14: SNA Bits 00 to 07: SA1 Responses Bit 15: ON Bits 08 to 14: DNA Bits 00 to 07: DA1		Check the command format and set the correct command data.	---
03C0	FINS/TCP setting error	01 to 10: Connection number	01: Automatically allocated FINS node address duplication 02: Destination IP address error 03: Destination port number error	Refer to <i>1-5-1 FINS Communications Service</i> in this manual and the <i>Operation Manual, Construction of Applications: Creating FINS Applications</i> and set the FINS/TCP settings correctly.	---

Error code	Meaning	Detailed error code		Correction	EE-PROM
		1st byte	2nd byte		
03C2	FINS/TCP packet discarded	01 to 10: Connection number	02: Reopened because remote node closed	Have the FINS/TCP connection status checked when a SEND(090), RECV(098), or CMND(490) instruction is executed in the ladder program.	---
			03: Reopened because of reception error		
			04: Reopened because of transmission error		
			05: Reopened because RST received from remote node		
			06: Reopened because of no keep-alive response		
			07: Illegal FINS/TCP procedure	Refer to <i>Operation Manual, Construction of Applications: Creating FINS Applications</i> , and correct the remote node (application on a personal computer).	---
			08: Insufficient memory during server processing	There is too much load (traffic) on the Ethernet Unit. Correct the system so that traffic is not concentrated.	---
			09: Insufficient memory during client processing		
			0A: Insufficient memory during node switching		
03C3	FINS/UDP packet discarded	00	01 to FE: Transmission source node address	The automatic generation (static) method was used as the IP address conversion method, so remote IP address information in internal memory could not be changed.	---
0601	CPU Bus Unit error	Arbitrary		Restart the CPU Unit. If the problem persists, replace the Ethernet Unit.	Saved
0602	CPU Bus Unit memory error	01: Read error 02: Write error	06: Error log	Restart the CPU Unit. If the problem persists, replace the Ethernet Unit.	Saved (except for error log)

Error code	Meaning	Detailed error code		Correction	EE-PROM
		1st byte	2nd byte		
0206	Participating nodes decreased (local node separated)	00	Number of separated nodes	Inspect the separated node, cables, and hub.	---
0207	Participating nodes decreased (local node not separated)	00	Number of separated nodes		---
0220	Separated nodes when participating nodes decreased	Nodes 1 to 16 (correspond to bits 00 to 15) (Byte 1: Bits 0 to 15, Byte 2: Bits 0 to 7)			---
0221		Nodes 17 to 32 (correspond to bits 00 to 15) (Byte 1: Bits 0 to 15, Byte 2: Bits 0 to 7)			---
0222		Nodes 33 to 48 (correspond to bits 00 to 15) (Byte 1: Bits 0 to 15, Byte 2: Bits 0 to 7)			---
0223		Nodes 49 to 64 (correspond to bits 00 to 15) (Byte 1: Bits 0 to 15, Byte 2: Bits 0 to 7)			---
0224		Nodes 65 to 80 (correspond to bits 00 to 15) (Byte 1: Bits 0 to 15, Byte 2: Bits 0 to 7)			---
0225		Nodes 81 to 96 (correspond to bits 00 to 15) (Byte 1: Bits 0 to 15, Byte 2: Bits 0 to 7)			---
0226		Nodes 97 to 112 (correspond to bits 00 to 15) (Byte 1: Bits 0 to 15, Byte 2: Bits 0 to 7)			---
0227		Nodes 113 to 128 (correspond to bits 00 to 15) (Byte 1: Bits 0 to 15, Byte 2: Bits 0 to 7)			---
0228		Nodes 129 to 144 (correspond to bits 00 to 15) (Byte 1: Bits 0 to 15, Byte 2: Bits 0 to 7)			---
0229		Nodes 145 to 160 (correspond to bits 00 to 15) (Byte 1: Bits 0 to 15, Byte 2: Bits 0 to 7)			---
022A		Nodes 161 to 176 (correspond to bits 00 to 15) (Byte 1: Bits 0 to 15, Byte 2: Bits 0 to 7)			---
022B		Nodes 177 to 192 (correspond to bits 00 to 15) (Byte 1: Bits 0 to 15, Byte 2: Bits 0 to 7)			---
022C		Nodes 193 to 208 (correspond to bits 00 to 15) (Byte 1: Bits 0 to 15, Byte 2: Bits 0 to 7)		---	

Error code	Meaning	Detailed error code		Correction	EE-PROM
		1st byte	2nd byte		
022D		Nodes 209 to 224 (correspond to bits 00 to 15) (Byte 1: Bits 0 to 15, Byte 2: Bits 0 to 7)			---
022E		Nodes 225 to 240 (correspond to bits 00 to 15) (Byte 1: Bits 0 to 15, Byte 2: Bits 0 to 7)			---
022F		Nodes 241 to 254 (correspond to bits 00 to 15) (Byte 1: Bits 0 to 15, Byte 2: Bits 0 to 7)			---

- Note**
- (1) The time information in the CPU Unit is used in the CPU Bus Units.
 - (2) If the time information cannot be read from the CPU Unit, the time stamp in the error log will be all zeros. This can occur due to CPU Unit startup error, unit number errors, CPU error, and model number errors. If the time is read out from a Programming Device, the time will be shown as all zeros in the year 2000.
 - (3) The battery must be installed in the CS/CJ-series CPU Unit, the power turned ON, and then the time set before the clock in the CPU Unit can be used. The time will not be set correctly in the error log unless the clock time is set correctly.
 - (4) An error record is not created in EEPROM when a CPU Bus Unit memory error occurs.

8-4 Troubleshooting Procedures

The following procedures can be used to troubleshoot various problems in system operation.

8-4-1 Startup Problems

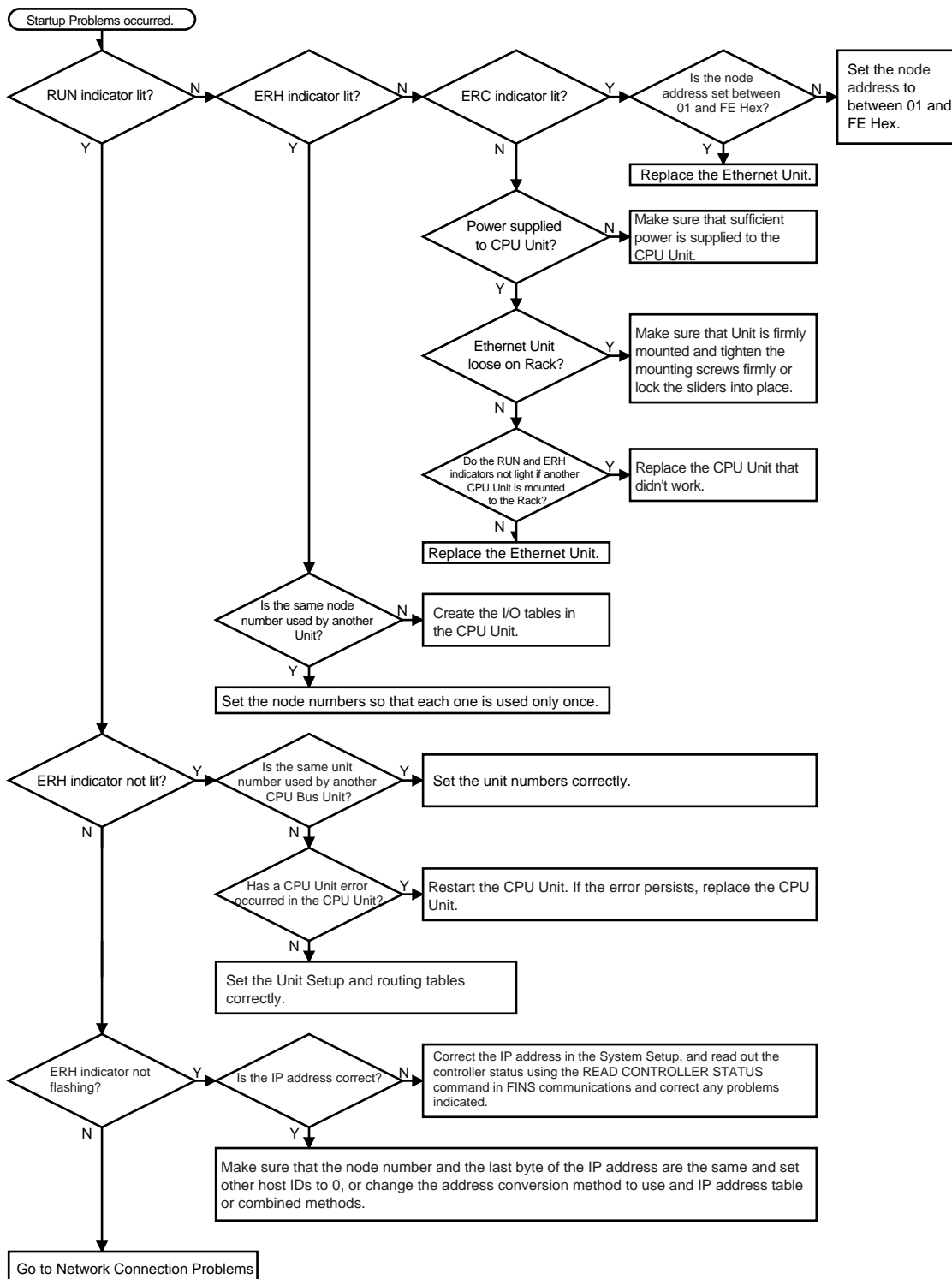

8-4-2 FINS Communications Problems (SEND(090)/RCV(098)/CMND(490))

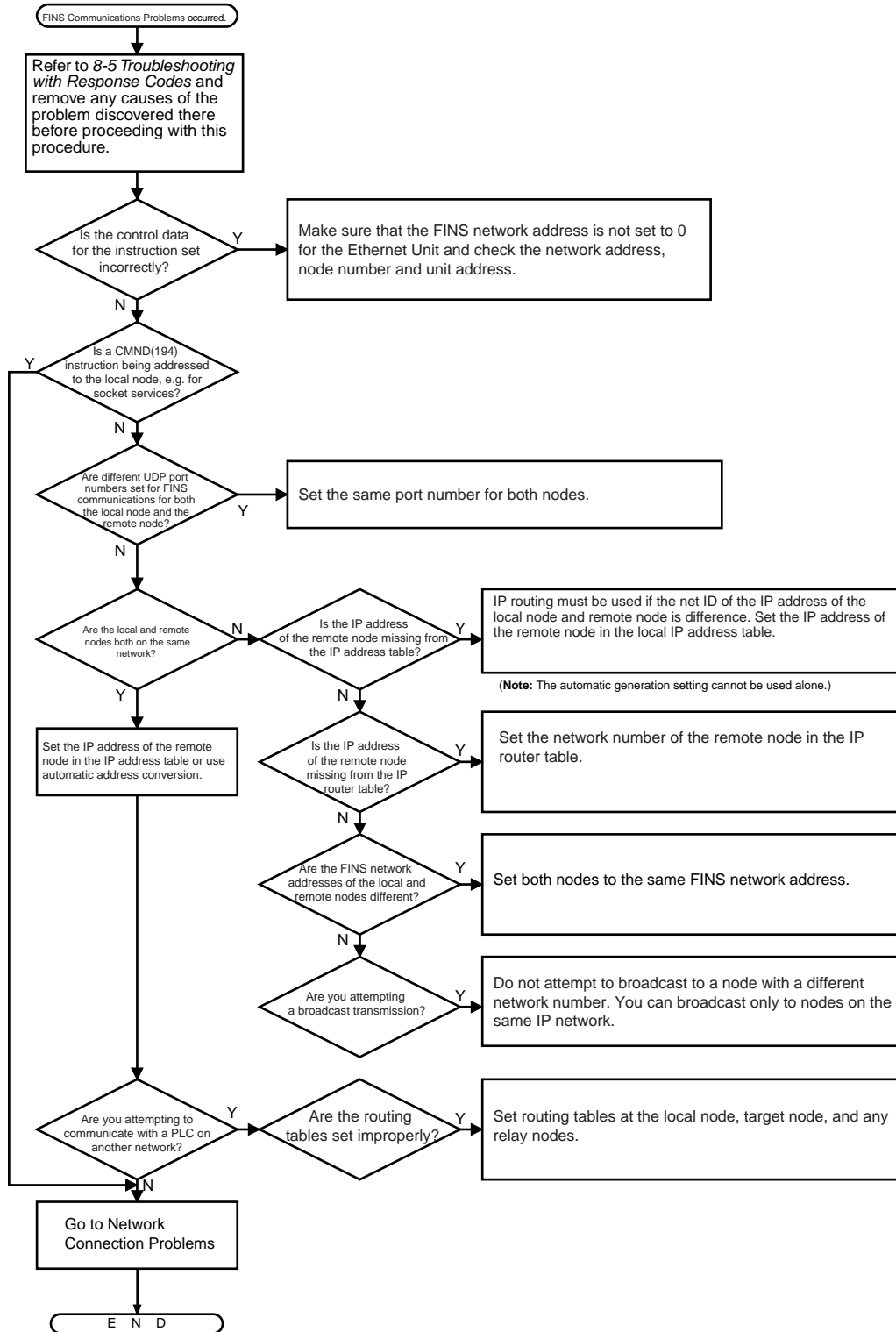

8-4-3 Network Connection Problems

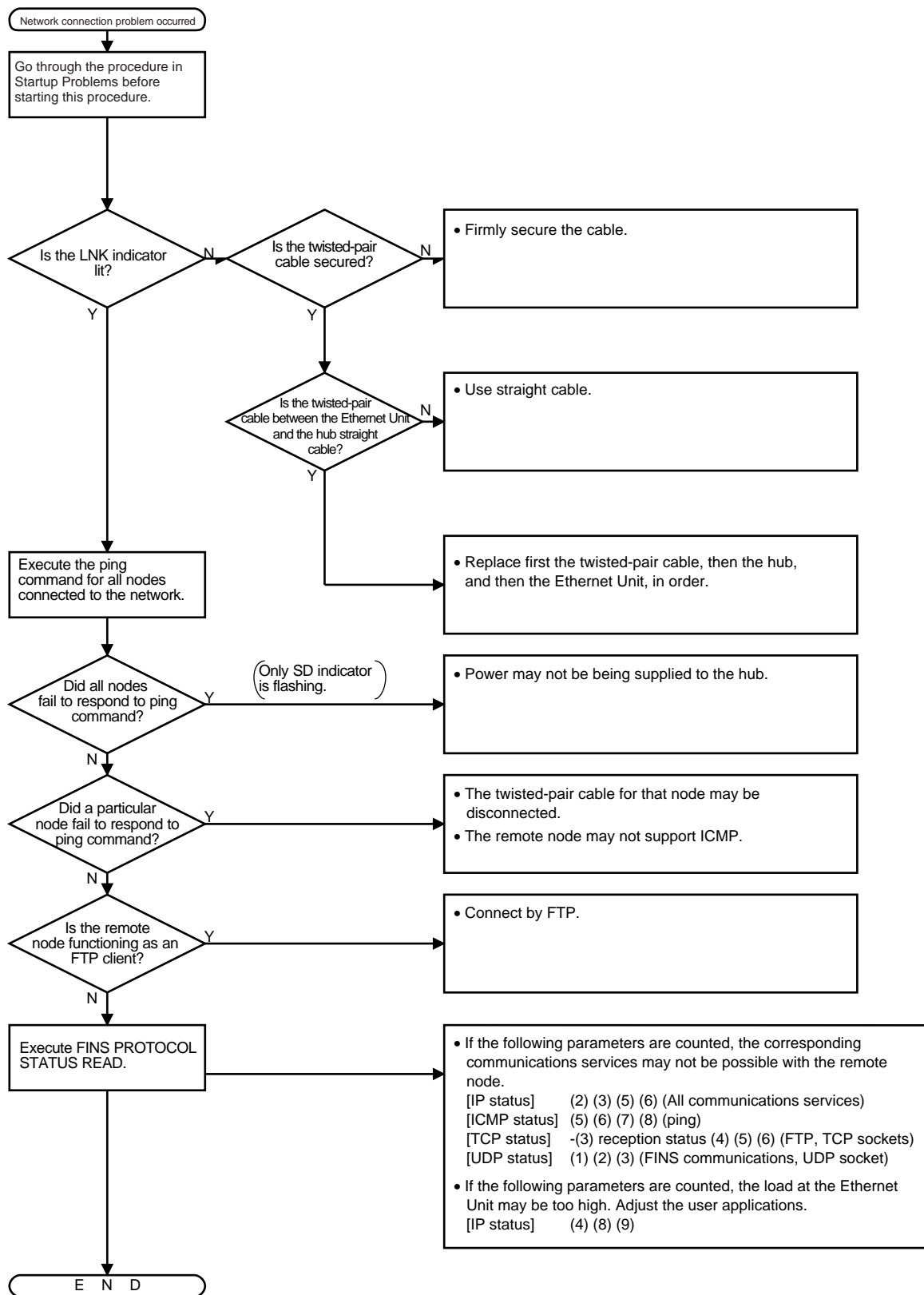

8-5 Troubleshooting with Response Codes

You can troubleshoot the errors in FINS communications from the response codes when the SEND(090), RECV(098), or CMND(490) instructions have been used. For the storage areas of the response codes refer to information on page 119 under 6-6-4 Writing Programs.

The table below lists response codes (main and sub-codes) returned after execution of FINS commands, the probable cause of errors, and recommended remedies. The response codes provided here are for the Ethernet Unit. Refer to the *FINS Command Reference Manual (W227)* or the operation manuals for the relevant Unit for further information on response codes.

The 6th, 7th, and 15th bits of the response codes have specific functions. The 6th bit will be ON when a non-fatal error has occurred in the PC at the remote node; the 7th bit will be ON when a fatal error has occurred in the PC at the remote node; and the 15th bit will be ON when a network relay error has occurred.

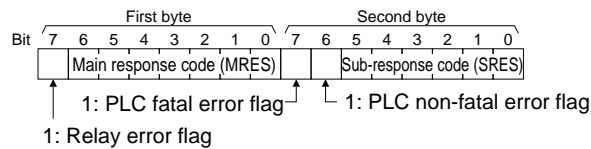

Main code	Sub-code	Probable cause	Remedy
00: Normal completion	00	---	---
01: Local node error	03	Send error in local node was caused by lack of available space in internal buffers.	Reduce the load (traffic) on the Ethernet Unit. Check your user applications.
	05	The network cannot be accessed because the IP address setting is not correct.	Correct the local IP address.
	07	The internal buffers are full because there is too much traffic at the local node, preventing data from being sent.	Correct the user application to reduce traffic at the Ethernet Unit.
02: Remote node error	01	IP address of remote node not set correctly in IP address table or IP router table.	Set IP address of remote node into IP address table and, if internetwork transmission is required, into the IP router table.
	02	No node with the specified unit address.	Check the remote node's unit address and make sure the correct one is being used in the control data.
	05	Message packet was corrupted by transmission error.	Check the protocol and controller status by reading them with FINS commands. Increase the number of transmit retry attempts.
		Response time-out, response watchdog timer interval too short.	Increase the value for the response monitor time in the control data.
		The transmission frame may be corrupted or the internal reception buffer full.	Read out the error log and correct as required.
03: Communications controller error	01	Error occurred in the communications controller, ERC indicator is lit.	Take corrective action, referring to troubleshooting procedures in this section.
	02	CPU Unit error occurred in the PLC at the remote node.	Check CPU Unit indicators at the remote node and clear the error in the CPU Unit (refer to the PC's operation manuals)
	04	Unit number setting error	Make sure the unit number is within the specified range and that the same unit number is not used twice in the same network.

Main code	Sub-code	Probable cause	Remedy
04: Not executable (Service not supported.)	01	An undefined command has been used.	Check the command code and be sure the command is supported by the Unit to which you are sending it.
		A short frame (4 bytes) is being used for the FINS header frame.	Check the FINS header frame length. The Ethernet Unit does not support short headers.
05: Routing error	01	Remote node is not set in the routing tables.	Set the destination address in the routing tables.
	02	Routing tables aren't registered completely.	Set routing tables at the local node, remote node, and any relay nodes.
	03	Routing table error	Set the routing tables correctly.
	04	The maximum number of relay nodes (2) was exceeded in the command.	Redesign the network or reconsider the routing table to reduce the number of relay nodes in the command. Communications are possible on three network levels, including the local network.
10: Command format error	01	The command is longer than the max. permissible length.	Check the command format of the command and set it correctly. Be sure broadcast transmissions don't exceed 1,473 bytes.
	02	The command is shorter than min. permissible length.	Check the command format of the command and set it correctly.
	03	The designated number of data items differs from the actual number in the command data.	Check the number of items and the data, and make sure that they agree.
	05	Data for another node on the same network was received from the network.	Check the header parameters in the command data and be sure the correct command format is being used.
An attempt was made to send response data for a broadcast address.			
11: Parameter error	00	The parameters in the command data are incorrect.	Check the parameters. Be sure the socket number is between 1 and 8. Set the Local UDP port number correctly.
		The UDP/TCP socket number was not within the proper range.	
		The local UDP port number might be set to 0.	
	01	A correct memory area code has not been used or EM Area is not available.	Check the command's memory area code in the Results Storage Area and set the appropriate code.
	03	The first word is in an inaccessible area or the bit number is not 00.	Set a first word that is in an accessible area. The bit number must be 00 for Ethernet Units.
	04	The address set in the command is not correct.	Correct the address in the command data, being sure that the start address plus the number of words does not exceed accessible memory.
0B	The response frame is too long.	Correct the number of data elements or other parameters in the command data for which the response is being returned.	
	0C	Parameters are set incorrectly in the command data.	Check the command data and correct any parameters that are incorrect.
21: Cannot write	08	With respect to a FINS node address that could not be dynamically changed, a FINS message was received from an IP address that differed from the Unit Setup.	Referring to <i>SECTION 5 Determining IP Addresses</i> , correct the relationships between IP addresses and FINS node addresses.

Main code	Sub-code	Probable cause	Remedy
22: Status error (operating mode disagreement)	0F	The same socket service is already in progress at the specified socket number.	Use the socket status flag in PC memory to be sure that socket service has finished before starting services again.
	10	The specified socket is not open.	Open the socket. For TCP sockets, be sure to wait until connection is made.
	11	The internal buffers are full because there is too much traffic at the local node, preventing data from being sent.	Correct the user application to reduce traffic at the Ethernet Unit.
	30	A connection is already established with the specified remote node.	Correct the settings for the FINS/TCP connection number, the remote IP address, and the remote port number.
	31	The specified connection number is not set as a FINS/TCP client in the Unit Setup.	Correct the settings for the Unit Setup, the FINS/TCP connection number, the remote IP address, and the remote port number.
	32	While a remote node change was being processed for the specified connection number, a request for a change was received and the processing was stopped.	Correct the settings for the FINS/TCP connection number, the remote IP address, and the remote port number.
23: Environment error (no such Unit)	05	IP address conversion failed.	Check the IP address and subnet mask in the System Setup and be sure that settings are correct.
	07	IP address conversion is set for automatic conversion only.	Check the mode settings in the System Setup. This error will be generated for the READ IP ADDRESS TABLE command only.

Network Relay Errors

For network relay errors using SEND(090) or RECV(098), check the path of the command using the routing tables and the nature of the error using the response code to eliminate the cause of the error.

For network relay errors using CMND(490), the location of the relay error is recorded in the second through third words of the response, as shown below.

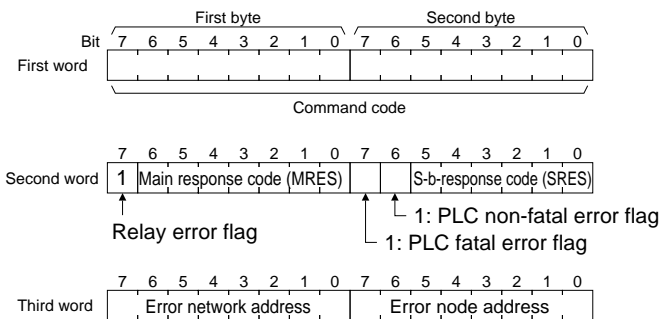

Appendix A

Ethernet Network Parameters

Parameter	Value	Description
TCP send buffer	4,096 bytes	Maximum capacity of the TCP send buffer
TCP receive buffer	4,096 bytes	Maximum capacity of the TCP receive buffer
UDP send buffer	9,000 bytes	Maximum capacity of the UDP send buffer
UDP receive buffer	9,016 bytes	Maximum capacity of the UDP receive buffer
FINS receive buffer	16,383 bytes	Maximum capacity of the FINS receive buffer
RAW send buffer	2,048 bytes	Maximum capacity of the RAW send buffer
RAW receive buffer	2,048 bytes	Maximum capacity of the RAW receive buffer
Hold timer	75 s (12 min max.)	The hold timer is used for active open processing of TCP sockets. An ETIMEDOUT error will occur if connection is not completed within 75 s.
Resend timer	Initial value: 1 s Maximum value: 64 s	The resend timer is used to monitor completion of reception of arrival confirmations when transferring data via socket services, including FTP server and mail transfer TCP sockets. If the timer setting is exceeded before arrival confirmation is received, data is resent. Resends are performed from the first timeout (1 s) through the 12th timeout (64 s). An ETIMEDOUT error will occur after the 12th timeout.
Continue timer	Initial value: 5 s Maximum value: 60 s	The continue timer starts if preparations have been completed to send data but the send window is too small (either 0 or too small) to send the data and the remote node has not requested that communications be restarted. Confirmation of the window size is requested from the remote node when the continue timer times out. The initial value of the timer is 5 s and confirmation processing will continue consecutively with increasingly longer times until the maximum time of 60 s is reached.
2MSL timer	60 s	The 2MSL timer starts at the TCP socket that first closes the socket and will run for 60 s in the TIME_WAIT status.
IP reassemble timer	12 s	A fragmented IP packet is discarded if it cannot be reassembled within 12 seconds.
ARP timer	20 min/3 min	If a complete ARP table entry (with an Ethernet address) is not referred to for 20 minutes, it is removed from the table. An incomplete ARP table entry (no response yet returned to the ARP request) is removed from the table after 3 minutes.
Window size (initial value of maximum window size)	4,096 bytes	The initial value of the maximum capacity used to control the convergence of TCP sockets. Actually, the node negotiates with the remote node and uses the smaller of the values for the two nodes. The window size will fluctuate with the available space in the TCP reception buffers of the remote node when processing communications.
Fragment size	1,500 bytes	Data packets are fragmented into 1,500-byte IP packets. UDP data is separated into 1,472-byte fragments before sending.
Segment size	1,024 bytes	TCP data is separated into 1,024-byte units, unless the segments are different, in which case it will be separated into 536-byte units.
TTL (Time to Live)	30	Decrement each time an IP router is passed.

Appendix B

Buffer Configuration

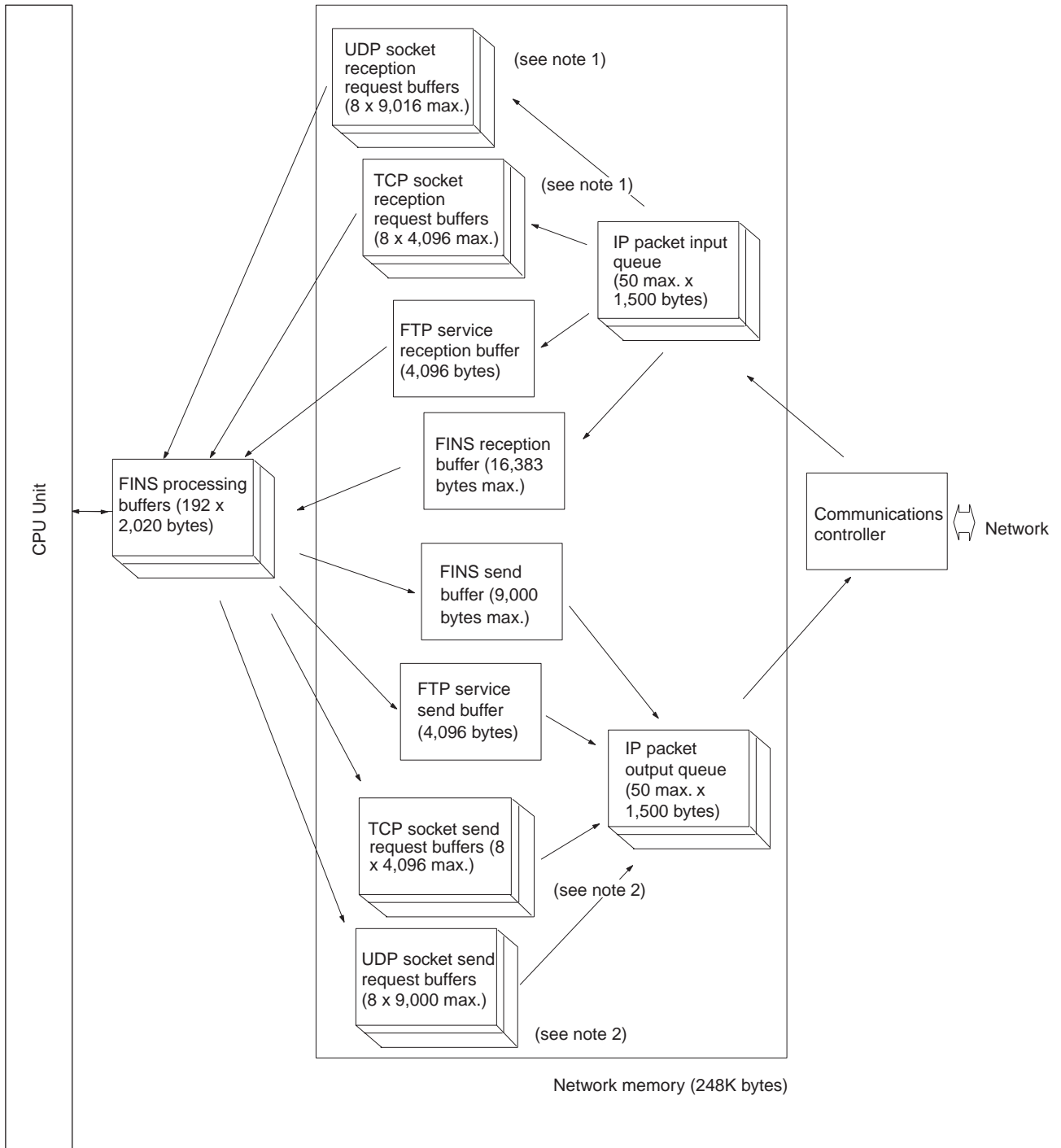

Network Memory

Most of the buffers used for communications servicing by the Ethernet Unit are administered in a buffer configuration called network memory. Network memory consists of 248K bytes of memory divided into short and long buffers. The use of short and long buffers is determined by the status of the various services when the Ethernet Unit is running. The capacity of all buffers cannot be used due to limits in the mounted memory capacity. The status of the short and long buffers can be accessed by execution the FINS command MEMORY STATUS READ (2763).

- Note**
1. The status of UDP and TCP socket reception request buffers can be accessed by executing the FINS command SOCKET STATUS READ (2764).
 2. The status of UDP and TCP socket send request buffers can be accessed by executing the FINS command SOCKET STATUS READ (2764).

Appendix C

TCP Status Transitions

The TCP socket status can be confirmed using the socket status data returned for the FINS command SOCKET STATUS READ (2764).

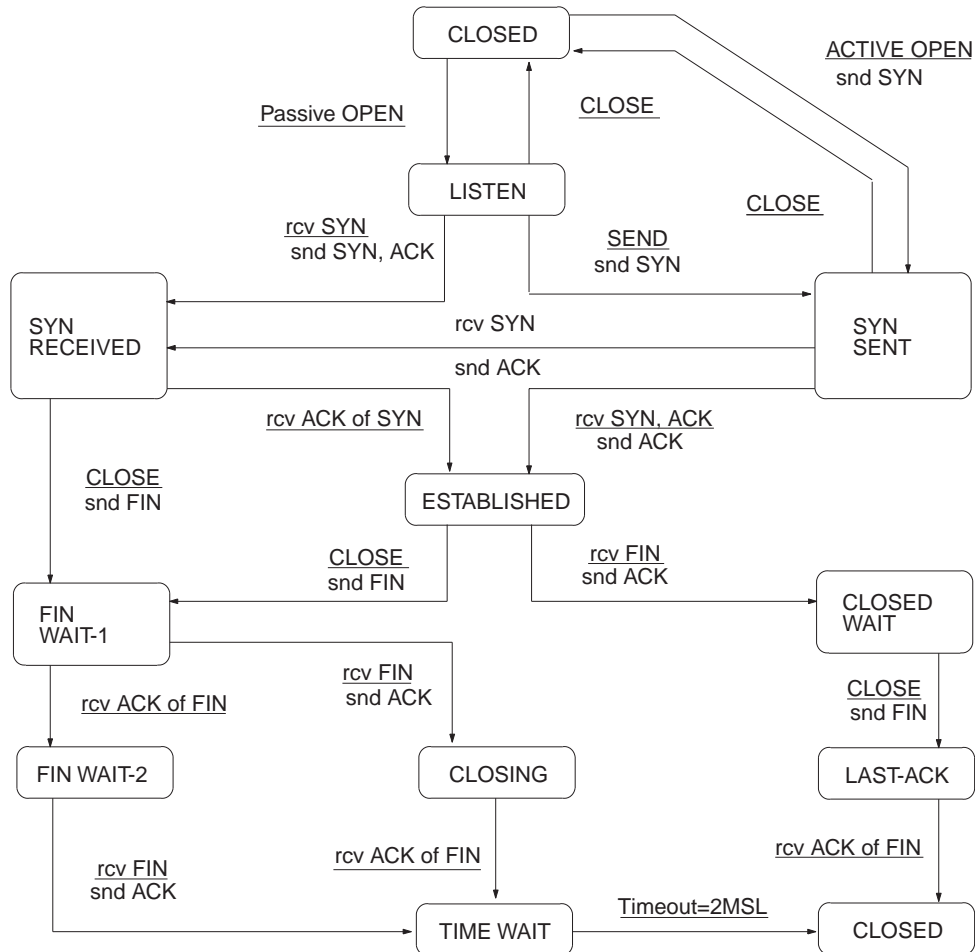

Appendix D

ASCII Characters

Bits 1 to 4		Bits 5 to 7							
Binary	Hex	0000	0001	0010	0011	0100	0101	0110	0111
		0	1	2	3	4	5	6	7
0000	0	NUL	DLE	Space	0	@	P		p
0001	1	SOH	DC1	!	1	A	Q	a	q
0010	2	STX	DC2	"	2	B	R	b	r
0011	3	ETX	DC3	#	3	C	S	c	s
0100	4	EOT	DC4	\$	4	D	T	d	t
0101	5	ENQ	NAK	%	5	E	U	e	u
0110	6	ACK	SYN	&	6	F	V	f	v
0111	7	BEL	ETB	'	7	G	W	g	w
1000	8	BS	CAN	(8	H	X	h	x
1001	9	HT	EM)	9	I	Y	i	y
1010	A	LF	SUB	*	:	J	Z	j	z
1011	B	VT	ESC	+	;	K	[k	{
1100	C	FF	FS	,	<	L	\	l	
1101	D	CR	GS	-	=	M]	m	}
1110	E	SO	RS	.	>	N	^	n	~
1111	F	SI	US	/	?	O	_	o	DEL

Appendix E

Maintenance

The Ethernet Unit makes up part of a network. Repair a defective Ethernet Unit as soon as possible as it can have a negative effect on the entire network. We recommend that customers keep one or more spare Ethernet Units to allow immediate recovery of the network.

Replacing an Ethernet Unit

Observe the following precautions when replacing the Ethernet Unit.

- Always turn OFF the power supply before replacing the Ethernet Unit.
- Check that the spare Ethernet Unit is operating normally before replacing a defective Unit with it.
- When returning a defective Unit for repairs, provide as much written information as possible on the symptoms of the problem.
- If a problem occurs with poor contacts, wipe the contacts with a clean cloth soaked with industrial alcohol. Carefully remove any lint remaining on the contacts before replacing the Unit.

Settings after Replacing an Ethernet Unit

After replacing an Ethernet Unit, set the following to the same settings as were used on the previous Unit.

- Unit number
- Node address

Settings after Replacing a CPU

The EEPROM in the PC's CPU holds the information listed below. This information must be stored in any new CPU used to replace a defective one.

- Routing tables
- System Setup for the Ethernet Unit

Appendix F

Inspections

Carry out regular inspections to ensure the Ethernet Unit is functioning perfectly.

Items

Most of the parts that make up an Ethernet Unit are semiconductor components. None of the parts in the Unit will wear out after a specific lifetime, but some parts may deteriorate due to extreme operating condition. Therefore, it is important to inspect the Unit regularly.

Inspection Interval

Normally inspect once or twice per year. Choose the inspection period according to the severity of the operating conditions. New installation should be inspected more frequently until they are judged to be stable.

Inspection Items

Correct any of the items in the table below not conforming to the specified standard.

Item	Details	Standard
Environment	Temperature around Unit	0 to 55°C
	Humidity around Unit	10% to 90% (with no condensation)
	Accumulated dust	No accumulated dust
Mounting	Ethernet Unit firmly attached	No looseness
	Transceiver cable connector fully pushed in	No looseness
	Condition of transceiver cable	No visible abnormality
	Twisted-pair cable connector fully pushed in	No looseness
	Condition of twisted-pair cable	No visible abnormality

Tools Required for Inspection

The following tools are needed to inspect the Ethernet Unit:

Standard Tools

- Flat-blade and Phillips screwdrivers
- Tester or digital voltmeter
- Industrial alcohol and a clean cloth

Tools Required Under Special Circumstances

- Synchroscope
- Pen oscilloscope
- Thermometer and hygrometer

Appendix G

Using a Memory Card Text File to Set Up an Ethernet Unit

Settings for the CS1D Ethernet Unit are normally made with CX-Programmer version 4.00 or higher. Instead of the CX-Programmer, a text file on a Memory Card can also be used to make the settings.

- Note**
- (1) Only the Unit Setup and the Duplex Communications Unit Settings in the PLC Setup can be made with a Memory Card text file.
 - (2) I/O table and routing table settings cannot be made with a Memory Card text file. Use any version of CX-Programmer to create the I/O tables and routing tables.

Requirements

The following are required to use a Memory Card text file.

- Memory Card with at least 10 KB of available space
- Programming Console or any version of CX-Programmer
- Windows computer and text editor

Procedure

Backup

First, back up the Ethernet Unit settings on a Memory Card (initially the default settings).

- 1,2,3...**
1. Mount the CS1D Ethernet Units and other Units to the CS1D PLC and create the I/O tables. Set the unit number of the Secondary Unit to one higher than the unit number of the Primary Unit.
 2. With the power supply still turned ON, insert the Memory Card into the CPU Unit. If the MCPWR indicator on the CPU Unit lights, the Memory Card has been mounted correctly.
 3. Turn ON the Memory Card Unit Setup Backup Bit allocated to the Primary Unit (bit 15 in CIO 1500 + (25 x unit number) using a Programming Console or other means. The BUSY indicator on the CPU Unit will light while the settings are being backed up.
 4. The BUSY indicator on the CPU Unit will go out and the Memory Card Unit Setup Backup Bit allocated to the Primary Unit (bit 15 in CIO 1500 + (25 x unit number) will turn OFF automatically when the backup has been completed.
 5. Press the power button for the Memory Card on the CPU Unit. The MCPWR indicator on the CPU Unit will go out. When this indicator goes out, remove the Memory Card.
 6. Check the text file created on the Memory Card on a Windows computer. The text file name will be as follows: ETN_(1)(2)(3)(4).INI
(1)(2): Node address (01 to FE hex)
(3)(4): Unit address (10 to 1F hex)
The unit address is the unit number in hexadecimal plus 10 hex.
 7. The contents of the text file is given in the following table.

Note # can be used for comments.

No.	Contents	Description
1	#[Duplex]	# indicates comments.
2	Duplex = N # Y: Duplex/N: Not Duplex	Duplex communications setting: Y: Duplex, N: Simplex
3		
4	#[System(Primary)]	
5	IpAddress = 0.0.0.0 # 0.0.0.0 - 255.255.255.255	IP address
6	SubNetMask = 0.0.0.0 # 0.0.0.0 - 255.255.255.255	Subnet mask
7	FinsUdpPortNo = 0 # 0 - 65535	FINS/UDP port user definition (value)
8	UserDefined(FinsUdpPortNo) = N # Y: Use/N: Don't use	FINS/UDP port user definition (default or user-defined selection)
9	FinsTcpPortNo = 0 # 0 - 65535	FINS/ TCP port user definition (value)
10	UserDefined(FinsTcpPortNo) = N # Y: Use/N: Don't use	FINS/TCP port user definition (default or user-defined selection)
11	AddressConversionMode = 1 # 1: Auto(Dynamic)/2: Auto(Static)	IP address conversion method
12	# 3: TableUsed/4: Mixed	
13	Broadcast = N # Y: All'0'(4.2BSD)/N: All'1'(4.3BSD)	Broadcast method
14	Baudrate = N # Y: 10Base-T/N: Auto detect	Baud rate
15	TcpIpKeep-aliveTime = 0 # 0 - 65535 (min)	TCP/IP keep-alive
16		
17	#[NetworkStatus(Primary)]	
18	NetworkStatusUdpPortNo = 0 # 0 - 65535	UDP port for network status (value)
19	UserDefined(NetStatUdpPortNo) = N # Y: Use/N: Don't use	UDP port for network status (default or user-defined selection)
20	IntervalTime = 0 # 0 - 255	Network status send interval
21	WatchTime = 0 # 0 - 255	Network status watch time
22		
23	#[IpAddressTable(Primary)]	
24	#	
25	# Example.	
26	#	
27	# IpTblXX = xxx , xxx.xxx.xxx.xxx	
28	# (1) -----(2)-----	
29	#	
30	# (1) FINS node address = 1 - 254	
31	# (2) IP address = 0.0.0.0 - 255.255.255.255	
32	#	
33	IpTbl01 = 0 , 0.0.0.0	IP address table
34	IpTbl02 = 0 , 0.0.0.0	
35	IpTbl03 = 0 , 0.0.0.0	
36	IpTbl04 = 0 , 0.0.0.0	
37	IpTbl05 = 0 , 0.0.0.0	
38	IpTbl06 = 0 , 0.0.0.0	
39	IpTbl07 = 0 , 0.0.0.0	
40	IpTbl08 = 0 , 0.0.0.0	
41	IpTbl09 = 0 , 0.0.0.0	
42	IpTbl10 = 0 , 0.0.0.0	
43	IpTbl11 = 0 , 0.0.0.0	
44	IpTbl12 = 0 , 0.0.0.0	

No.	Contents	Description	
45	IpTbl13 = 0 , 0.0.0.0		
46	IpTbl14 = 0 , 0.0.0.0		
47	IpTbl15 = 0 , 0.0.0.0		
48	IpTbl16 = 0 , 0.0.0.0		
49	IpTbl17 = 0 , 0.0.0.0		
50	IpTbl18 = 0 , 0.0.0.0		
51	IpTbl19 = 0 , 0.0.0.0		
52	IpTbl20 = 0 , 0.0.0.0		
53	IpTbl21 = 0 , 0.0.0.0		
54	IpTbl22 = 0 , 0.0.0.0		
55	IpTbl23 = 0 , 0.0.0.0		
56	IpTbl24 = 0 , 0.0.0.0		
57	IpTbl25 = 0 , 0.0.0.0		
58	IpTbl26 = 0 , 0.0.0.0		
59	IpTbl27 = 0 , 0.0.0.0		
60	IpTbl28 = 0 , 0.0.0.0		
61	IpTbl29 = 0 , 0.0.0.0		
62	IpTbl30 = 0 , 0.0.0.0		
63	IpTbl31 = 0 , 0.0.0.0		
64	IpTbl32 = 0 , 0.0.0.0		
65			
66	#[IpRouterTable(Primary)]		
67	#		
68	# Example.		
69	#		
70	# RtTblXX = xxx.xxx.xxx.xxx , xxx.xxx.xxx.xxx		
71	# ------(1)----- ------(2)-----		
72	#		
73	# (1) IP network address = 0.0.0.0 - 255.255.255.255		
74	# (2) Router IP address = 0.0.0.0 - 255.255.255.255		
75	#		
76	RtTbl01 = 0.0.0.0 , 0.0.0.0		IP router table
77	RtTbl02 = 0.0.0.0 , 0.0.0.0		
78	RtTbl03 = 0.0.0.0 , 0.0.0.0		
79	RtTbl04 = 0.0.0.0 , 0.0.0.0		
80	RtTbl05 = 0.0.0.0 , 0.0.0.0		
81	RtTbl06 = 0.0.0.0 , 0.0.0.0		
82	RtTbl07 = 0.0.0.0 , 0.0.0.0		
83	RtTbl08 = 0.0.0.0 , 0.0.0.0		
84			
85	#[FinsTCPConnection(Primary)]		
86	#		
87	# Example.		
88	#		
89	# FinsTcpXX = X , xxx.xxx.xxx.xxx , xxx , X , X		
90	# (1) ------(2)----- (3) (4) (5)		
91	#		
92	# (1) Mode = S: FINS/TCP server/C: FINS/TCP client		
93	# (2) IP address = 0.0.0.0 - 255.255.255.255		

No.	Contents	Description
94	# (3) Auto allocated fins node No = 1 - 254	
95	# (4) keep-alive = Y: Valid keep-alive/ N: Not valid keep-alive	
96	#	
97	UseIpAddressToProtect = N # Y: Protect/N: Not Protect // (Server Only)	Protects IP addresses
98	FinsTcp01 = S, 0.0.0.0, 239, Y	FINS/TCP connection settings
99	FinsTcp02 = S, 0.0.0.0, 240, Y	
100	FinsTcp03 = S, 0.0.0.0, 241, Y	
101	FinsTcp04 = S, 0.0.0.0, 242, Y	
102	FinsTcp05 = S, 0.0.0.0, 243, Y	
103	FinsTcp06 = S, 0.0.0.0, 244, Y	
104	FinsTcp07 = S, 0.0.0.0, 245, Y	
105	FinsTcp08 = S, 0.0.0.0, 246, Y	
106	FinsTcp09 = S, 0.0.0.0, 247, Y	
107	FinsTcp10 = S, 0.0.0.0, 248, Y	
108	FinsTcp11 = S, 0.0.0.0, 249, Y	
109	FinsTcp12 = S, 0.0.0.0, 250, Y	
110	FinsTcp13 = S, 0.0.0.0, 251, Y	
111	FinsTcp14 = S, 0.0.0.0, 252, Y	
112	FinsTcp15 = S, 0.0.0.0, 253, Y	
113	FinsTcp16 = S, 0.0.0.0, 254, Y	

Setting Notation

The settings required for duplex operation are explained here. Other settings are left at their defaults.

The setting for duplex operation is made by changing the contents of the text file using a text editor. Set line number 2 to Duplex = Y.

To change any other settings, refer to the comments after “#” in the text file and edit the contents according to them. Do not make more than the required changes and leave all lines and comments as given in the example.

The settings on lines 4 to 113 are repeated for the Secondary Unit in the same file. It's most convenient to copy the lines for the Primary Unit after setting them and then just paste them for the Secondary Unit and then correcting “Primary” to “Secondary” in the Secondary Unit settings.

The contents of the text file is given below.

No.	Contents
1	#[Duplex]
2	Duplex = Y # Y: Duplex/N: Not Duplex
3	
4	#[System(Primary)]
5	IpAddress = 0.0.0.0 # 0.0.0.0 - 255.255.255.255
6	SubNetMask = 0.0.0.0 # 0.0.0.0 - 255.255.255.255
7	FinsUdpPortNo = 0 # 0 - 65535
8	UserDefined(FinsUdpPortNo) = N # Y: Use/N: Don't use
9	FinsTcpPortNo = 0 # 0 - 65535
10	UserDefined(FinsTcpPortNo) = N # Y: Use/N: Don't use
11	AddressConversionMode = 1 # 1: Auto(Dynamic)/2: Auto(Static)
12	# 3: TableUsed/4: Mixed
13	BroadCast = N # Y: All'0'(4.2BSD)/N: All'1'(4.3BSD)
14	Boudrate = N # Y: 10Base-T/N: Auto detect

No.	Contents
15	TcplpKeep-aliveTime = 0 # 0 - 65535 (min)
16	
17	#[NetworkStatus(Primary)]
18	NetworkStatusUdpPortNo = 0 # 0 - 65535
19	UserDefined(NetStatUdpPortNo) = N # Y: Use/N: Don't use
20	IntervalTime = 0 # 0 - 255
21	WatchTime = 0 # 0 - 255
22	
23	#[IpAddressTable(Primary)]
24	#
25	# Example.
26	#
27	# IpTblXX = xxx , xxx.xxx.xxx.xxx
28	# (1) -----(2)-----
29	#
30	# (1) FINS node address = 1 - 254
31	# (2) IP address = 0.0.0.0 - 255.255.255.255
32	#
33	IpTbl01 = 0 , 0.0.0.0
34	IpTbl02 = 0 , 0.0.0.0
35	IpTbl03 = 0 , 0.0.0.0
36	IpTbl04 = 0 , 0.0.0.0
37	IpTbl05 = 0 , 0.0.0.0
38	IpTbl06 = 0 , 0.0.0.0
39	IpTbl07 = 0 , 0.0.0.0
40	IpTbl08 = 0 , 0.0.0.0
41	IpTbl09 = 0 , 0.0.0.0
42	IpTbl10 = 0 , 0.0.0.0
43	IpTbl11 = 0 , 0.0.0.0
44	IpTbl12 = 0 , 0.0.0.0
45	IpTbl13 = 0 , 0.0.0.0
46	IpTbl14 = 0 , 0.0.0.0
47	IpTbl15 = 0 , 0.0.0.0
48	IpTbl16 = 0 , 0.0.0.0
49	IpTbl17 = 0 , 0.0.0.0
50	IpTbl18 = 0 , 0.0.0.0
51	IpTbl19 = 0 , 0.0.0.0
52	IpTbl20 = 0 , 0.0.0.0
53	IpTbl21 = 0 , 0.0.0.0
54	IpTbl22 = 0 , 0.0.0.0
55	IpTbl23 = 0 , 0.0.0.0
56	IpTbl24 = 0 , 0.0.0.0
57	IpTbl25 = 0 , 0.0.0.0
58	IpTbl26 = 0 , 0.0.0.0
59	IpTbl27 = 0 , 0.0.0.0
60	IpTbl28 = 0 , 0.0.0.0
61	IpTbl29 = 0 , 0.0.0.0
62	IpTbl30 = 0 , 0.0.0.0
63	IpTbl31 = 0 , 0.0.0.0

No.	Contents
64	IpTbl32 = 0 , 0.0.0.0
65	
66	#[IpRouterTable(Primary)]
67	#
68	# Example.
69	#
70	# RtTblXX = xxx.xxx.xxx.xxx , xxx.xxx.xxx.xxx
71	# ------(1)----- ------(2)-----
72	#
73	# (1) IP network address = 0.0.0.0 - 255.255.255.255
74	# (2) Router IP address = 0.0.0.0 - 255.255.255.255
75	#
76	RtTbl01 = 0.0.0.0 , 0.0.0.0
77	RtTbl02 = 0.0.0.0 , 0.0.0.0
78	RtTbl03 = 0.0.0.0 , 0.0.0.0
79	RtTbl04 = 0.0.0.0 , 0.0.0.0
80	RtTbl05 = 0.0.0.0 , 0.0.0.0
81	RtTbl06 = 0.0.0.0 , 0.0.0.0
82	RtTbl07 = 0.0.0.0 , 0.0.0.0
83	RtTbl08 = 0.0.0.0 , 0.0.0.0
84	
85	#[FinsTCPConnection(Primary)]
86	#
87	# Example.
88	#
89	# FinsTcpXX = X , xxx.xxx.xxx.xxx , xxx , X , X
90	# (1) ------(2)----- (3) (4) (5)
91	#
92	# (1) Mode = S: FINS/TCP server/C: FINS/TCP client
93	# (2) IP address = 0.0.0.0 - 255.255.255.255
94	# (3) Auto allocated fins node No = 1 - 254
95	# (4) keep-alive = Y: Valid keep-alive/ N: Not valid keep-alive
96	#
97	UselpAddressToProtect = N # Y: Protect/N: Not Protect // (Server Only)
98	FinsTcp01 = S, 0.0.0.0, 239, Y
99	FinsTcp02 = S, 0.0.0.0, 240, Y
100	FinsTcp03 = S, 0.0.0.0, 241, Y
101	FinsTcp04 = S, 0.0.0.0, 242, Y
102	FinsTcp05 = S, 0.0.0.0, 243, Y
103	FinsTcp06 = S, 0.0.0.0, 244, Y
104	FinsTcp07 = S, 0.0.0.0, 245, Y
105	FinsTcp08 = S, 0.0.0.0, 246, Y
106	FinsTcp09 = S, 0.0.0.0, 247, Y
107	FinsTcp10 = S, 0.0.0.0, 248, Y
108	FinsTcp11 = S, 0.0.0.0, 249, Y
109	FinsTcp12 = S, 0.0.0.0, 250, Y
110	FinsTcp13 = S, 0.0.0.0, 251, Y
111	FinsTcp14 = S, 0.0.0.0, 252, Y
112	FinsTcp15 = S, 0.0.0.0, 253, Y

No.	Contents
113	FinsTcp16 = S, 0.0.0.0, 254, Y
114	
115	#[System(Secondary)]
116	IpAddress = 0.0.0.0 # 0.0.0.0 - 255.255.255.255
117	SubNetMask = 0.0.0.0 # 0.0.0.0 - 255.255.255.255
118	FinsUdpPortNo = 0 # 0 - 65535
119	UserDefined(FinsUdpPortNo) = N # Y: Use/N: Don't use
120	FinsTcpPortNo = 0 # 0 - 65535
121	UserDefined(FinsTcpPortNo) = N # Y: Use/N: Don't use
122	AddressConversionMode = 1 # 1: Auto(Dynamic)/2: Auto(Static)
123	# 3: TableUsed/4: Mixed
124	Broadcast = N # Y: All'0'(4.2BSD)/N: All'1'(4.3BSD)
125	Baudrate = N # Y: 10Base-T/N: Auto detect
126	TcplpKeep-aliveTime = 0 # 0 - 65535 (min)
127	
128	#[NetworkStatus(Secondary)]
129	NetworkStatusUdpPortNo = 0 # 0 - 65535
130	UserDefined(NetStatUdpPortNo) = N # Y: Use/N: Don't use
131	IntervalTime = 0 # 0 - 255
132	WatchTime = 0 # 0 - 255
133	
134	#[IpAddressTable(Secondary)]
135	#
136	# Example.
137	#
138	# IpTblXX = xxx , xxx.xxx.xxx.xxx
139	# (1) -----(2)-----
140	#
141	# (1) FINS node address = 1 - 254
142	# (2) IP address = 0.0.0.0 - 255.255.255.255
143	#
144	IpTbl01 = 0 , 0.0.0.0
145	IpTbl02 = 0 , 0.0.0.0
146	IpTbl03 = 0 , 0.0.0.0
147	IpTbl04 = 0 , 0.0.0.0
148	IpTbl05 = 0 , 0.0.0.0
149	IpTbl06 = 0 , 0.0.0.0
150	IpTbl07 = 0 , 0.0.0.0
151	IpTbl08 = 0 , 0.0.0.0
152	IpTbl09 = 0 , 0.0.0.0
153	IpTbl10 = 0 , 0.0.0.0
154	IpTbl11 = 0 , 0.0.0.0
155	IpTbl12 = 0 , 0.0.0.0
156	IpTbl13 = 0 , 0.0.0.0
157	IpTbl14 = 0 , 0.0.0.0
158	IpTbl15 = 0 , 0.0.0.0
159	IpTbl16 = 0 , 0.0.0.0
160	IpTbl17 = 0 , 0.0.0.0
161	IpTbl18 = 0 , 0.0.0.0

No.	Contents
162	IpTbl19 = 0 , 0.0.0.0
163	IpTbl20 = 0 , 0.0.0.0
164	IpTbl21 = 0 , 0.0.0.0
165	IpTbl22 = 0 , 0.0.0.0
166	IpTbl23 = 0 , 0.0.0.0
167	IpTbl24 = 0 , 0.0.0.0
168	IpTbl25 = 0 , 0.0.0.0
169	IpTbl26 = 0 , 0.0.0.0
170	IpTbl27 = 0 , 0.0.0.0
171	IpTbl28 = 0 , 0.0.0.0
172	IpTbl29 = 0 , 0.0.0.0
173	IpTbl30 = 0 , 0.0.0.0
174	IpTbl31 = 0 , 0.0.0.0
175	IpTbl32 = 0 , 0.0.0.0
176	
177	#[IpRouterTable(Secondary)]
178	#
179	# Example.
180	#
181	# RtTblXX = xxx.xxx.xxx.xxx , xxx.xxx.xxx.xxx
182	# -----(1)----- -----(2)-----
183	#
184	# (1) IP network address = 0.0.0.0 - 255.255.255.255
185	# (2) Router IP address = 0.0.0.0 - 255.255.255.255
186	#
187	RtTbl01 = 0.0.0.0 , 0.0.0.0
188	RtTbl02 = 0.0.0.0 , 0.0.0.0
189	RtTbl03 = 0.0.0.0 , 0.0.0.0
190	RtTbl04 = 0.0.0.0 , 0.0.0.0
191	RtTbl05 = 0.0.0.0 , 0.0.0.0
192	RtTbl06 = 0.0.0.0 , 0.0.0.0
193	RtTbl07 = 0.0.0.0 , 0.0.0.0
194	RtTbl08 = 0.0.0.0 , 0.0.0.0
195	
196	#[FinsTCPConnection(Secondary)]
197	#
198	# Example.
199	#
200	# FinsTcpXX = X , xxx.xxx.xxx.xxx , xxx , X , X
201	# (1) -----(2)----- (3) (4) (5)
202	#
203	# (1) Mode = S: FINS/TCP server/C: FINS/TCP client
204	# (2) IP address = 0.0.0.0 - 255.255.255.255
205	# (3) Auto allocated fins node No = 1 - 254
206	# (4) keep-alive = Y: Valid keep-alive/N: Not valid keep-alive
207	#
208	UselpAddressToProtect = N # Y: Protect/N: Not Protect // (Server Only)
209	FinsTcp01 = S, 0.0.0.0, 239, Y
210	FinsTcp02 = S, 0.0.0.0, 240, Y

No.	Contents
211	FinsTcp03 = S, 0.0.0.0, 241, Y
212	FinsTcp04 = S, 0.0.0.0, 242, Y
213	FinsTcp05 = S, 0.0.0.0, 243, Y
214	FinsTcp06 = S, 0.0.0.0, 244, Y
215	FinsTcp07 = S, 0.0.0.0, 245, Y
216	FinsTcp08 = S, 0.0.0.0, 246, Y
217	FinsTcp09 = S, 0.0.0.0, 247, Y
218	FinsTcp10 = S, 0.0.0.0, 248, Y
219	FinsTcp11 = S, 0.0.0.0, 249, Y
220	FinsTcp12 = S, 0.0.0.0, 250, Y
221	FinsTcp13 = S, 0.0.0.0, 251, Y
222	FinsTcp14 = S, 0.0.0.0, 252, Y
223	FinsTcp15 = S, 0.0.0.0, 253, Y
224	FinsTcp16 = S, 0.0.0.0, 254, Y

Settings

The settings required for duplex operation are explained here. Other settings are left at their defaults.

1,2,3...

1. Insert the Memory Card with the corrected setup file into the CPU Unit. If the MCPWR indicator on the CPU Unit lights, the Memory Card has been mounted correctly.
2. Turn ON the Memory Card Unit Setup Setting Bit allocated to the Primary Unit (bit 14 in CIO 1500 + (25 x unit number) using a Programming Console or other means. The BUSY indicator on the CPU Unit will light while the settings are being made.
3. The BUSY indicator on the CPU Unit will go out and the Memory Card Unit Setup Setting Bit allocated to the Primary Unit (bit 14 in CIO 1500 + (25 x unit number) will turn OFF automatically when the backup has been completed.
4. Check the results of the setting operation in the Error Information in CIO 1518 + (25 x unit number).

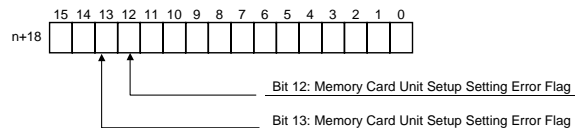

5. If an error bit has been turned ON, check the error code in CIO 1519 + (25 x unit number).

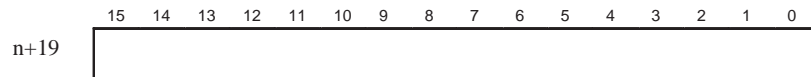

When the Memory Card Unit Setup Setting Error Bit Is ON

- The line number of the setting with the error in the setup file is stored in hexadecimal.

When the Memory Card Unit Setup Access Error Bit Is ON

- One of the following error codes is stored depending on the status of the Memory Card or setup file.

Error code	Meaning
0000	Normal
2201	Execution is not possible because an operation is already being performed. (More than one control bit for the Memory Card Unit Setup function has turned ON at the same time.)
2006	So such file (Either the Memory Card or a setup file is missing.)
2101	Write-protected via switch setting.
2103	Too many files (An attempt was made to create more than the registered number of files.)
2301	No file device (A Memory Card is not inserted.)
250F	An access error occurred, such as a damaged file device (e.g., Memory Card).

- If the Memory Card Unit Setup Access Error Flag is ON, the ERH indicator will flash.
 - To clear an error, correct the problem and perform the setup procedure again or turn ON the Memory Card Unit Setup Error Clear Bit (bit 13 of CIO 1500 + (25 x unit number).
6. If there is not error, the settings have been completed normally. Turn OFF the power supply.
 7. Change the unit number of the Secondary Unit to the number one higher than that of the Primary Unit.
 8. Turn ON the power supply.
 9. Confirm that the DPL indicator is lit on the Primary Unit and lit on the Secondary Unit. This completes the procedure.

Note The node address and unit address of the Primary Unit are given in the text file name on the Memory Card. It is convenient to prepare in advance as may node text files as possible in the root folder.

Index

Numerics

100M indicator, 18

A

applications precautions, xix

ARP communications, 12

ASCII characters, 183

Auto allocated FINS node field, 55

Auxiliary Area, 114

B

baud rate

CS-series, 11

setting, 44

Baud Rate field, 53

bits

addresses, 66

error status, 62, 63, 163

service status, 61

status of UDP/TCP sockets, 61

BROADCAST DATA SEND, 141

Broadcast field, 52

broadcast setting, 44

broadcast test

command, 141

reading results, 141

BROADCAST TEST RESULTS READ, 141

buffers, 155, 177

configuration, 179

C

C200H-PRO27-E, 36

cables

communications, xxi

connections, 35

installation, 33

precautions, 32

twisted-pair, 7

CS-series, 11

cascade connections, 32

CS-series, 11

CIO Area, 114

allocations, 58

CMND(490) instruction, 13, 117

commands

FINS commands, 134

communications cables, xxi

Communications Port Enabled Flags, 66, 119

Communications Port Error Flags, 119

connectors

recommended models, 31

Contact Output Units

installation, 33

interference with Ethernet, 33

precautions, 33

CONTROLLER DATA READ, 136

CONTROLLER STATUS READ, 137, 139

Conversion field, 53

Counter Area, 114

CPU Bus Unit Error Flag, 67

CPU Bus Unit Error, Unit Number Flags, 67

CPU Bus Unit Initializing Flags, 66

CPU Bus Unit Number Duplication Flags, 67

CPU Bus Unit Restart Bits, 70

CPU Bus Unit Setting Error Flag, 67

CPU Bus Unit Setting Error, Unit Number Flags, 67

CPU Bus Unit System Setup Area, 8

CPU Bus Units

flags, 66

Restart Bits, 70

CQM1-PRO01-E, 36

crimp terminals, xx

CS1W-CN114, 36

CS1W-CN224, 36

CS1W-CN624, 36

CS1W-KS001-E, 36

current consumption

CS-series, 11

CX-Net, 9, 36

creating routing tables, 99

CX-Programmer, 36

connecting to PLC, 3, 102

from personal computer, 4, 5

through multiple segments, 4, 5

using wireless LAN, 4, 5

within same segment, 3

creating routing tables, 99

Ethernet Unit Setup, 39

D

dimensions, 12

CS-series, 11

DM Area, 114

allocations, 65

Driver Tab, 103

E

EC Directives, xxi

echo response packet, 46

electromagnetic fields, xix

EM Area, 114

EMC Directives, xxi

EMI countermeasures, 34

EMI Standard, xxi

EMS Standard, xxi

ERC indicator, 18

troubleshooting, 162

ERH indicator, 19

troubleshooting, 162

ERROR LOG CLEAR, 143

ERROR LOG READ, 141

errors

alignment, 138

controller status, 137, 139

error codes, 165

error log, 164

clearing, 143

reading, 141

error status, 163

flags

FINS communications, 137

response codes, 174

short packets, 138

status, 62, 63, 163

unit numbers, 67

Ethernet communications, 12

addresses

reading from Unit, 136

parameters, 177

Ethernet Connector, 17, 34

Ethernet Unit Setup, 39

Ethernet Units

mounting, 29

reading status, 155

replacing, 185

resetting, 135

F

FINS communications, 13

commands, 134, 135

from PLCs, 113

sending, 113

data contents, 113

data length, 113

destination, 113

echo test, 46

overview, 13

port numbers, 113

response codes, 134, 174

response monitor time, 113

responses, 135

retries, 113

specifications, 91, 113

TCP/IP, 4, 5

testing, 143

troubleshooting, 172

UDP/IP, 3, 5

FINS/TCP, 4, 5, 91, 94

communications, 96

connection numbers, 95

connection status, 96

features, 94

frame format, 95

procedure, 97

TCP port number, 95

FINS/TCP Mode field, 54

FINS/TCP Port field, 52

FINS/TCP Tab, 53

FINS/UDP, 3, 5, 91, 92

frame format, 92

procedure, 93

UDP port numbers, 93

FINS/UDP Port field, 52

FinsGateway, 9, 107

flags

Communications Port Enabled Flags, 66

Communications Port Error Flags, 66

CPU Bus Unit Error Flag, 67

CPU Bus Unit Error Unit Number Flags, 67

CPU Bus Unit Initializing Flags, 66

CPU Bus Unit Number Duplication Flags, 67

CPU Bus Unit Setting Error Flag, 67

CPU Bus Unit Setting Error Unit Number Flags, 67
Error Flags, 137
FTP communications, 13

H

Holding Area, 114
hub, 7, 31
connections
 cascade, 32
 stack, 33
installation, 34
precautions, 32

I

I/O allocations, 114
 CIO Area, 58
 DM Area, 65
I/O tables
 creating, 36
ICMP communications, 12
 status, 152
indicators, 18
 troubleshooting, 162
inspections, 187, 189
installation
 cables
 connections, 35
 Contact Output Units, 33
 location, xix
 precautions, 30
interlock circuits, xx
INTERNODE ECHO TEST, 140
internode test
 command, 140
IP Address field, 52, 54
IP Address Table field, 53
IP ADDRESS TABLE READ, 148
IP addresses
 allocating, 72
 configuration, 72
 setting, 42
IP communications, 12
 IP addresses
 reading from Units, 136
 reading tables, 148
 IP router tables

 reading, 149
 status, 151
IP Router Table field, 53
IP ROUTER TABLE READ, 149
IP router tables, 44

K

keep-alive field, 55
keep-alive setting, 44

L

limit circuits, xx
LNK indicator, 19
locking devices
 precautions, xx
Low Voltage Directive, xxi

M

main response code, 134
 See also MRES
maintenance, 185
media access method
 CS-series, 11
MEMORY STATUS READ, 155
mode settings
 reading from Unit, 136
modulation method
 CS-series, 11
mounting
 Racks, 29
MRES, 134

N

Network Tab, 103
networks
 network memory, 155, 180
No. field, 54
node addresses
 setting, 28
Node Number Switches, 17
noise, xix
 Contact Output Units, 33

O

- online editing, xviii
- operating environment
 - ambient humidity
 - CS-series, 11
 - ambient temperature
 - CS-series, 11
 - precautions, xix

P

- PCMR(260) instruction, 120
- PING, 46, 143
 - application examples, 47
 - echo test, 46
- port numbers
 - UDP port
 - reading from Unit, 136
- power supply, xix
 - precautions, xx
- precautions, xvii
 - applications, xix
 - Contact Output Units, 33
 - general, xviii
 - inspections, 187, 189
 - installation, 29, 30
 - operating environment, xix
 - power supply, xx
 - replacing Units, 185
 - safety, xviii
 - wiring, 35
- Programming Console, 36
- Programming Devices
 - connecting, 36
 - CX-Net, 36
 - CX-Programmer, 36
 - Programming Console, 36
- PROTOCOL STATUS READ, 151
- protocols, 12
 - ARP, 12
 - FINS, 13
 - FTP, 13
 - ICMP, 12
 - IP, 12
 - reading status, 151
 - TCP, 13
 - UDP, 13

R

- Racks
 - mounting Ethernet Units, 29
- radioactivity, xix
- RD indicator, 19
- RECV(098) instruction, 13, 116
- relay tables, 99
- RESET, 135
- response codes, 174
 - FINS commands, 134
- Routing Table Area, 9
- routing tables
 - creating, 98
 - local network table, 98
 - relay network table, 99
 - setting examples, 100
- RUN indicator, 18
 - troubleshooting, 162

S

- safety precautions, xviii
- SD indicator, 19
- SEND(090) instruction, 13, 115
 - transmission delay, 125
- service status, 61
- Setup Tab, 52
- shock resistance
 - CS-series, 11
- short-circuits
 - precautions, xx
- signals
 - precautions, xx
- SOCKET STATUS READ, 157, 181
- sockets
 - reading status, 157
 - TCP sockets
 - status, 181
 - testing communications, 143
- software
 - configuration, 12
- specifications
 - Ethernet Units
 - CS-series, 11
 - FINS communications, 113
- SRES, 134
- stack connections, 33

startup
 procedure, 22

static electricity, xix
 precautions, xxi

status
 reading memory status, 155
 reading protocol status, 151
 reading socket status, 157

storage temperature
 CS-series, 11

Sub-net Mask field, 52

subnet masks, 43, 73
 reading from Unit, 136

sub-response code, 134
 See also SRES

switches
 Socket Service Request Switches, 63

SYSMAC BUS/2, 114

SYSMAC LINK, 114

system configuration, 7
 examples, 103

T

TCP communications, 13
 sockets
 status, 181
 status, 153

TCP indicator, 19

TCP/IP, 4, 5, 91

TCP/IP keep-alive, 44, 53

terminal blocks, xix

Timer Area, 114

timers, 177

transmission
 delays, 125
 distance
 CS-series, 11
 media
 CS-series, 11
 path
 CS-series, 11

troubleshooting
 FINS communications, 172
 procedures, 171
 startup, 171
 using indicators, 162
 using response codes, 174

twisted-pair cables, 7
 precautions, 32
 recommended models, 31

U

UDP communications, 13

UDP/IP, 3, 5, 91

UDP/TCP sockets
 status bits, 61

Unit Number Switch, 17

unit numbers
 setting, 26

Use IP address to protect field, 54

V

vibration resistance
 CS-series, 11

Visual BASIC, 9

Visual C++, 9

W

weight
 CS-series, 11

wiring
 cables, 35
 precautions, 35

word addresses, 66

Work Area, 114

WS02-CXPC1-EV3, 36

Revision History

A manual revision code appears as a suffix to the catalog number on the front cover of the manual.

Cat. No. W430-E1-02



Revision code

The following table outlines the changes made to the manual during each revision. Page numbers refer to the previous version.

Revision code	Date	Revised content
1	January 2004	Original production
02	June 2008	Page xiii: Added information on warranty and applicability. Page xvii: Added "including the setting of the startup mode." Page 32: Changed cable specification in figure. Page 52: Changed setting range at bottom of page. Page 53: Changed setting range at top of page. Page 139: Corrected response block data in middle of page and mode settings at bottom of page. Page 140: Corrected byte numbers at top of page.

Revision History

OMRON Corporation
Industrial Automation Company

Control Devices Division H.Q.

Motion Control Department

Shiokoji Horikawa, Shimogyo-ku,
Kyoto, 600-8530 Japan

Tel: (81) 75-344-7173/Fax: (81) 75-344-7149

2-2-1 Nishikusatsu, Kusatsu-shi,
Shiga, 525-0035 Japan

Tel: (81) 77-565-5223/Fax: (81) 77-565-5568

Regional Headquarters

OMRON EUROPE B.V.

Wegalaan 67-69-2132 JD Hoofddorp
The Netherlands

Tel: (31)2356-81-300/Fax: (31)2356-81-388

OMRON Industrial Automation Global: www.ia.omron.com

OMRON ELECTRONICS LLC

One Commerce Drive Schaumburg,
IL 60173-5302 U.S.A.

Tel: (1) 847-843-7900/Fax: (1) 847-843-7787

OMRON ASIA PACIFIC PTE. LTD.

No. 438A Alexandra Road # 05-05/08 (Lobby 2),
Alexandra Technopark, Singapore 119967

Tel: (65) 6835-3011/Fax: (65) 6835-2711

OMRON (CHINA) CO., LTD.

Room 2211, Bank of China Tower,

200 Yin Cheng Zhong Road,

PuDong New Area, Shanghai, 200120, China

Tel: (86) 21-5037-2222/Fax: (86) 21-5037-2200

Authorized Distributor:

© OMRON Corporation 2004 All Rights Reserved.
In the interest of product improvement,
specifications are subject to change without notice.

Cat. No. W430-E1-02

Printed in Japan
0608