



# C200H-AD002/DA002

## Analog I/O Units

### Operation Guide

*Revised July 2000*

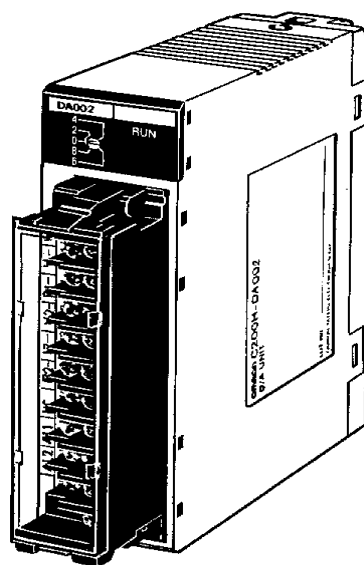
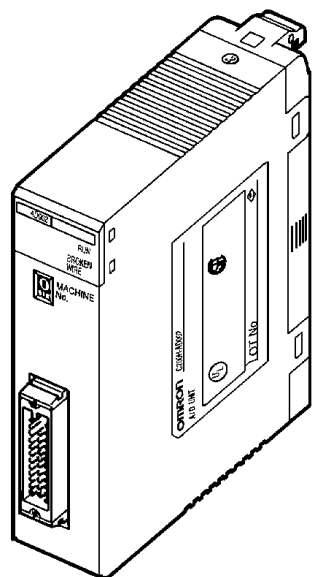





## **Notice:**

OMRON products are manufactured for use according to proper procedures by a qualified operator and only for the purposes described in this manual.

The following conventions are used to indicate and classify precautions in this manual. Always heed the information provided with them. Failure to heed precautions can result in injury to people or damage to the product.

 **DANGER** Indicates an imminently hazardous situation which, if not avoided, will result in death or serious injury.

 **WARNING** Indicates a potentially hazardous situation which, if not avoided, could result in death or serious injury.

 **Caution** Indicates a potentially hazardous situation which, if not avoided, may result in minor or moderate injury, or property damage.

## **OMRON Product References**

All OMRON products are capitalized in this manual. The word “Unit” is also capitalized when it refers to an OMRON product, regardless of whether or not it appears in the proper name of the product.

The abbreviation “Ch,” which appears in some displays and on some OMRON products, often means “word” and is abbreviated “Wd” in documentation in this sense.

The abbreviation “PC” means Programmable Controller and is not used as an abbreviation for anything else.

## **Visual Aids**

The following headings appear in the left column of the manual to help you locate different types of information.

**Note** Indicates information of particular interest for efficient and convenient operation of the product.

**1, 2, 3...** 1. Indicates lists of one sort or another, such as procedures, checklists, etc.

## **© OMRON, 1995**

All rights reserved. No part of this publication may be reproduced, stored in a retrieval system, or transmitted, in any form, or by any means, mechanical, electronic, photocopying, recording, or otherwise, without the prior written permission of OMRON.

No patent liability is assumed with respect to the use of the information contained herein. Moreover, because OMRON is constantly striving to improve its high-quality products, the information contained in this manual is subject to change without notice. Every precaution has been taken in the preparation of this manual. Nevertheless, OMRON assumes no responsibility for errors or omissions. Neither is any liability assumed for damages resulting from the use of the information contained in this publication.



# TABLE OF CONTENTS

## **PRECAUTIONS** .....

- 1 Intended Audience .....
- 2 General Precautions .....
- 3 Safety Precautions .....
- 4 Operating Environment Precautions .....
- 5 Application Precautions .....

## **SECTION 1**

### **System Design** .....

- 1-1 Introduction .....
- 1-2 Safety Precautions .....
- 1-3 Basic Configuration .....
- 1-4 Example Configurations .....
- 1-5 System Considerations .....

## **SECTION 2**

### **C200H-AD002 Analog Input Unit** .....

- 2-1 Before Operation .....
- 2-2 Bit and DM Area Allocations .....
- 2-3 Functions and Programming .....
- 2-4 Data Setting and Programming Examples .....
- 2-5 Troubleshooting .....

## **SECTION 3**

### **C200H-DA002 Analog Output Units** .....

- 3-1 Before Operation .....
- 3-2 Bit and DM Allocations .....
- 3-3 Troubleshooting .....

## **Appendices**

- A Standard Models .....
- B Specifications .....
- C Data Memory Coding Sheet .....

## **Index** .....

## **Revision History** .....

## About this Manual:

This manual describes the installation and operation of the C200H-AD002 Analog Input Unit and the C200H-DA002 Analog Output Unit and includes the sections described below.

The C200H-AD002 Analog Input Unit and the C200H-DA002 Analog Output Unit are analog-digital and digital-analog converters designed to work with the C200H or C200HS PC.

The C200H-AD002 can convert up to eight analog inputs into digital form. The operator can select from four input ranges: 1 to 5 V, 0 to 10 V, -10 to 10 V, and 4 to 20 mA. Useful functions, such as scaling, mean value, peak value, and square root, are built-in.

The C200H-DA002 can convert four digital signals into analog outputs. The operator can select from two output ranges: -10 to 10 V and 4 to 20 mA.

Please read this manual carefully and be sure you understand the information provided before attempting to install and operate the C200H-AD002 or the C200H-DA002.

**Section 1** describes the types of applications in which Analog I/O Units are used.

**Section 2** describes the installation and operation of the C200H-AD002 Analog Input Unit, from installation and wiring through programming and operation.

**Section 3** describes the installation and operation of the C200H-DA002 Analog Output Unit, from installation and wiring through programming and operation.

The **Appendices** provide information on standard models, specifications, and a data memory coding sheet.



### **WARNING**

Failure to read and understand the information provided in this manual may result in personal injury or death, damage to the product, or product failure. Please read each section in its entirety and be sure you understand the information provided in the section and related sections before attempting any of the procedures or operations given.

# PRECAUTIONS

This section provides general precautions for using the Programmable Controller (PC) and Analog I/O Units.

**The information contained in this section is important for the safe and reliable application of the Analog I/O Units. You must read this section and understand the information contained before attempting to set up or operate a PC system and Analog I/O Units.**

- 1 Intended Audience .....
- 2 General Precautions .....
- 3 Safety Precautions .....
- 4 Operating Environment Precautions .....
- 5 Application Precautions .....

## 1 Intended Audience

This manual is intended for the following personnel, who must also have knowledge of electrical systems (an electrical engineer or the equivalent).

- Personnel in charge of installing FA systems
- Personnel in charge of designing FA systems
- Personnel in charge of managing FA systems and facilities

## 2 General Precautions

The user must operate the product according to the performance specifications described in the operation manuals.

Before using the product under conditions which are not described in the manual or applying the product to nuclear control systems, railroad systems, aviation systems, vehicles, combustion systems, medical equipment, amusement machines, safety equipment, and other systems, machines, and equipment that may have a serious influence on lives and property if used improperly, consult your OMRON representative.

Make sure that the ratings and performance characteristics of the product are sufficient for the systems, machines, and equipment, and be sure to provide the systems, machines, and equipment with double safety mechanisms.

This manual provides information for programming and operating OMRON Analog I/O Units. Be sure to read this manual before attempting to use the software and keep this manual close at hand for reference during operation.

 **WARNING** It is extremely important that a PC and all PC Units be used for the specified purpose and under the specified conditions, especially in applications that can directly or indirectly affect human life. You must consult with your OMRON representative before applying a PC System to the above-mentioned applications.



## 3 Safety Precautions

 **WARNING** Do not attempt to take any Unit apart while power is being supplied. Doing so may result in electric shock.

 **WARNING** Do not touch any of the terminals or terminal blocks while power is being supplied. Doing so may result in electric shock.





## 4 Operating Environment Precautions

-  **Caution** Do not operate the control system in the following places:
- Locations subject to direct sunlight.
  - Locations subject to temperatures or humidity outside the range specified in the specifications.
  - Locations subject to condensation as the result of severe changes in temperature.
  - Locations subject to corrosive or flammable gases.
  - Locations subject to dust (especially iron dust) or salts.
  - Locations subject to exposure to water, oil, or chemicals.
  - Locations subject to shock or vibration.
-  **Caution** Take appropriate and sufficient countermeasures when installing systems in the following locations:
- Locations subject to static electricity or other forms of noise.
  - Locations subject to strong electromagnetic fields.
  - Locations subject to possible exposure to radioactivity.
  - Locations close to power supplies.
-  **Caution** The operating environment of the PC System can have a large effect on the longevity and reliability of the system. Improper operating environments can lead to malfunction, failure, and other unforeseeable problems with the PC System. Be sure that the operating environment is within the specified conditions at installation and remains within the specified conditions during the life of the system.

## 5 Application Precautions

Observe the following precautions when using the PC.

-  **WARNING** Always heed these precautions. Failure to abide by the following precautions could lead to serious or possibly fatal injury.
- Always connect to a ground of 100  $\Omega$  or less when installing the Units. Not connecting to a ground of 100  $\Omega$  or less may result in electric shock.
  - Always turn off the power supply to the PC before attempting any of the following. Not turning off the power supply may result in malfunction or electric shock.
    - Mounting or dismounting I/O Units, CPU Units, Memory Cassettes, or any other Units.
    - Assembling the Units.
    - Setting DIP switch or rotary switches.
    - Connecting or wiring the cables.
    - Connecting or disconnecting the connectors.
-  **Caution** Failure to abide by the following precautions could lead to faulty operation of the PC or the system, or could damage the PC or PC Units. Always heed these precautions.
- Fail-safe measures must be taken by the customer to ensure safety in the event of incorrect, missing, or abnormal signals caused by broken signal lines, momentary power interruptions, or other causes.

- Interlock circuits, limit circuits, and similar safety measures in external circuits (i.e., not in the Programmable Controller) must be provided by the customer.
- Always use the power supply voltage specified in this manual. An incorrect voltage may result in malfunction or burning.
- Take appropriate measures to ensure that the specified power with the rated voltage and frequency is supplied. Be particularly careful in places where the power supply is unstable. An incorrect power supply may result in malfunction.
- Do not apply voltages to the Input Units in excess of the rated input voltage. Excess voltages may result in burning.
- Do not apply voltages or connect loads to the Output Units in excess of the maximum switching capacity. Excess voltage or loads may result in burning.
- Install external breakers and take other safety measures against short-circuiting in external wiring. Insufficient safety measures against short-circuiting may result in burning.
- Disconnect the functional ground terminal when performing withstand voltage tests. Not disconnecting the functional ground terminal may result in burning.
- Do not attempt to disassemble, repair, or modify any Units.
- Be sure that all the mounting screws, terminal screws, and cable connector screws are tightened to the torque specified in the relevant manuals. Incorrect tightening torque may result in malfunction.
- Leave the label attached to the Unit when wiring. Removing the label may result in malfunction if foreign matter such as wire cuttings enter the Unit.
- Remove the label after the completion of wiring to ensure proper heat dissipation. Leaving the label attached may result in malfunction.
- Use crimp terminals for wiring. Do not connect bare stranded wires directly to terminals. Connection of bare stranded wires may result in burning.
- Double-check all the wiring before turning on the power supply. Incorrect wiring may result in burning.
- Wire all connections correctly.
- Mount the Unit only after checking the terminal block completely.
- Be sure that the terminal blocks, Memory Units, expansion cables, and other items with locking devices are properly locked into place. Improper locking may result in malfunction.
- Check the user program for proper execution before actually running it on the Unit. Not checking the program may result in an unexpected operation.
- Confirm that no adverse effect will occur in the system before attempting any of the following. Not doing so may result in an unexpected operation.
  - Changing the operating mode of the PC.
  - Force-setting/force-resetting any bit in memory.
  - Changing the present value of any word or any set value in memory.
- Resume operation only after transferring to the new CPU Unit the contents of the DM Area, HR Area, and other data required for resuming operation. Not doing so may result in an unexpected operation.
- Do not pull on the cables or bend the cables beyond their natural limit. Doing either of these may break the cables.
- Do not place objects on top of the cables or other wiring lines. Doing so may break the cables.
- Before touching the Unit, be sure to first touch a grounded metallic object in order to discharge any static built-up. Not doing so may result in malfunction or damage.
- Install the Units properly as specified in the operation manuals. Improper installation of the Units may result in malfunction.

# SECTION 1

## System Design

This section describes the basic uses of Analog I/O Units in a control system and illustrates the type of applications in which they might be found.

1-1	Introduction .....
1-2	Safety Precautions .....
1-3	Basic Configuration .....
1-4	Example Configurations .....
1-5	System Considerations .....

## 1-1 Introduction

The C200H-AD002 Analog Input Unit is used to convert the output of analog field devices, usually sensors, to a digital form that the PC can read. The C200H-DA002 Analog Output Unit converts the digital output of the PC to analog signals which drive analog field devices.

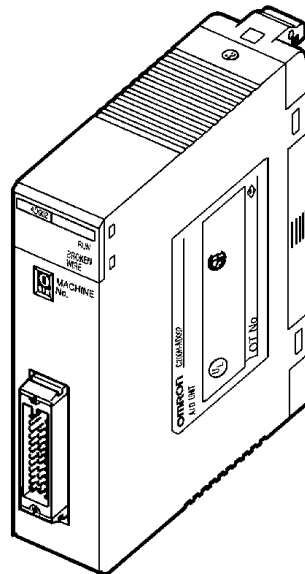

C200H-AD002  
Analog Input Unit

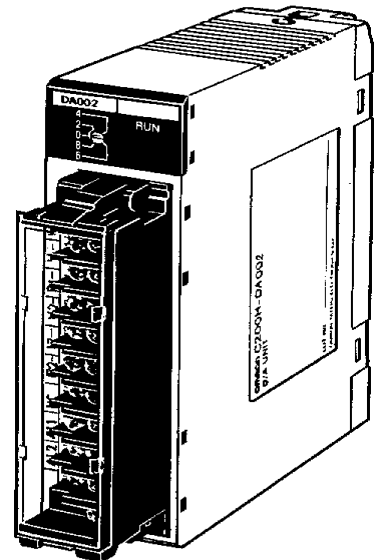

C200H-DA002  
Analog Output Unit

## 1-2 Safety Precautions

- Be sure to read this manual carefully and understand the explanations before attempting any of the procedures described herein. OMRON accepts no responsibility for any damage or injury that may result from carrying out any operation that is not covered in this manual.
- Be sure to turn off the power supply to the PC before carrying out any of the following operations:
  - a) Mounting or removing a Unit.
  - b) Setting switches.
  - c) Mounting or removing a Terminal Block or connectors.
  - d) Wiring the system or Units.
- Use twisted-pair cables and keep high-voltage lines and power lines in separate ducts to reduce the risk of malfunctions due to electrical noise.
- Before turning on the power supply, check to be sure that the switch settings and wiring are correct.
- Check to be sure that the user program operates correctly.

### 1-3 Basic Configuration

This diagram shows some of the possible field devices for the Analog I/O Units. Any I/O device can be used as long as voltage/current requirements fall within the specified ranges.

The I/O device connected to the Analog I/O Unit will often serve as an interface for another device. For example, a preamplifier may amplify the output of a pressure gauge to the level required for the Analog Input Unit and a regulator may interface a heating system to control temperature.

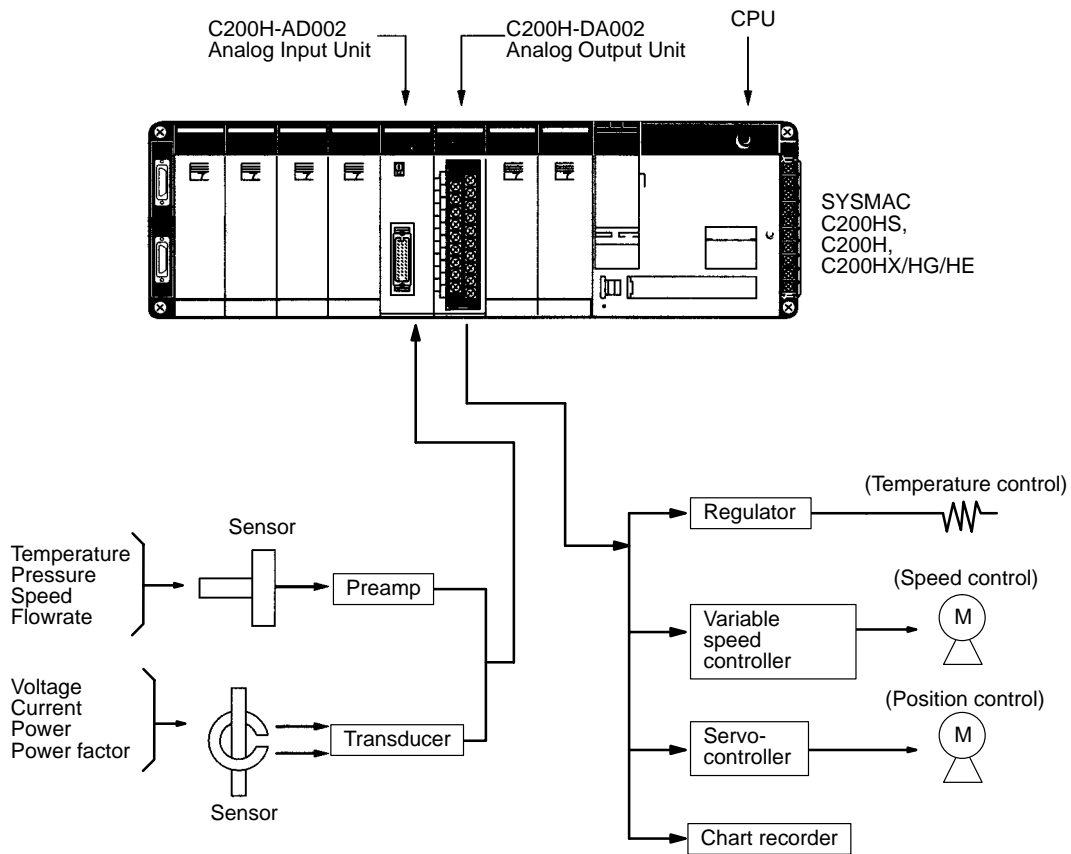

# 1-4 Example Configurations

Below are two examples of how Analog I/O Units can be used in control systems. The first diagram shows a temperature regulating system and the second shows a servomotor positioning system.

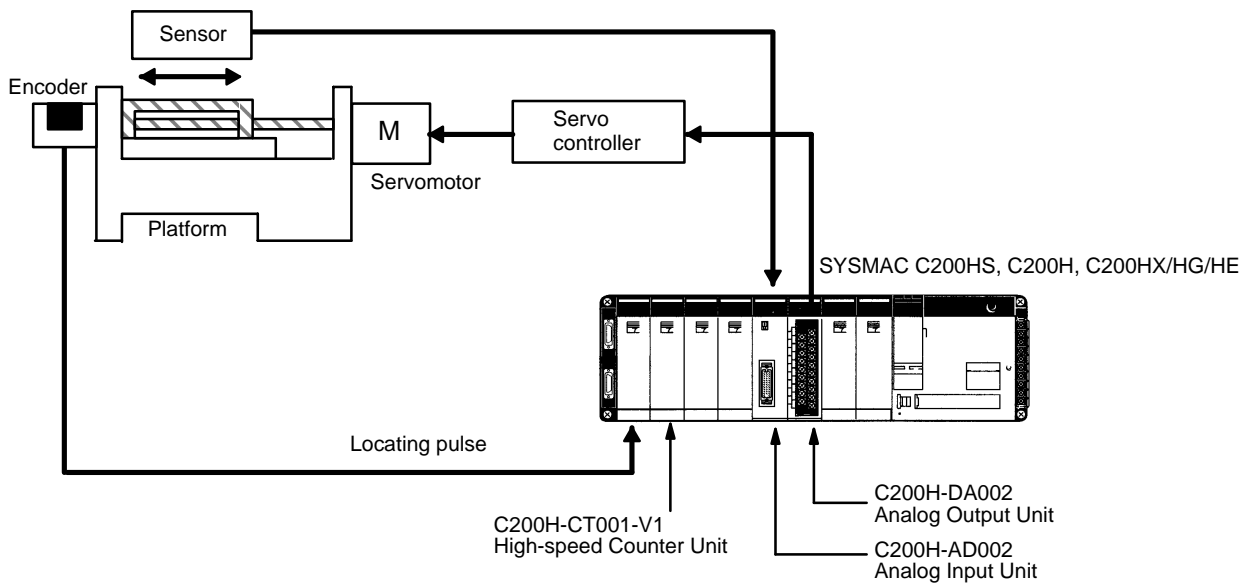
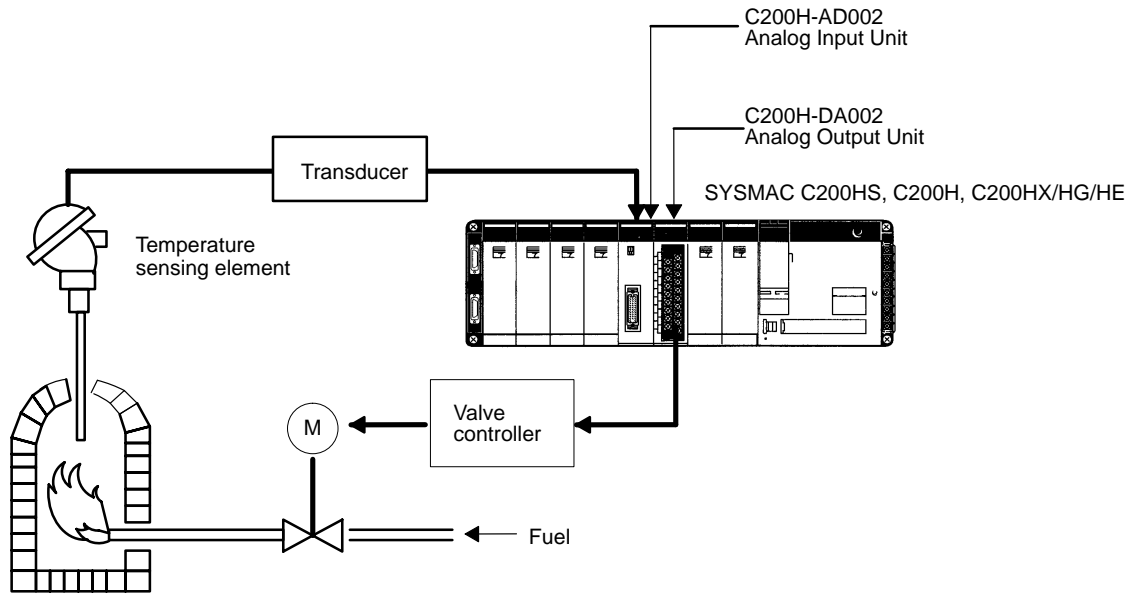

## 1-5 System Considerations

### Number of Units

The Analog I/O Units are classified as Special I/O Units for the C200HS, C200H, and C200HX/HG/HE. For most Units, a maximum total of ten Special I/O Units (including PC Link Units) can be mounted to the CPU Rack, Expansion I/O Racks, and Slave Racks of a single PC. A single C200H-NC211 Position Control Unit counts as two Units.

The unit numbers of the following Units can be set to between 0 and F Hex (0 to 15 decimal) instead of 0 to 9 when they are used with the C200HG-CPU53/CPU63 or C200HX-CPU54/CPU64 CPU Units. This enables mounting up to 16 Special I/O Units.

C200H-AD002, C200H-DA002, C200H-NC211, and C200H-CT201 with lot numbers □□16 or later (January 1996 or later)

The Units that belong to the various Special I/O Unit groups are shown in the following table. Their usage is limited according to the maximum current provided for the Rack and the amount of current consumed by each Unit. For details, refer to the *Installation Guide*.

### Slave Racks

Certain limitations apply to the number of Special I/O Units that can be mounted on Slave Racks. The following table shows the maximum number of Group A, B, C, and D Special I/O Units that can be mounted on a single Slave Rack when only Units of that group are used.

A	B	C	D
High-speed Counters Position Control Units (NC111/112) ASCII Units Analog I/O Units ID Sensor Units Fuzzy Logic Units	High-density I/O Units Temperature Control Units PID Control Units Cam Positioner Units	Temperature Sensor Units Voice Units	Position Control Units (NC211)
4 Units	---	---	---
---	8 Units	---	---
---	---	6 Units	---
---	---	---	2 Units

If Units from any of the four groups are to be combined, then both of the following two equations must be satisfied.

$$3A + B + 2C + 6D \leq 12$$

$$A + B + C + D \leq 8$$

Units can be mounted on other Racks as well, until the maximum total of ten Units has been reached. Remember, however, that a single C200H-NC211 Position Control Unit counts as two Units. PC Link Units must also be counted among the total of ten Units.

### System Configuration Considerations

C200HS/C200H Special I/O Units are allocated IR area words according to the unit number switch settings on their front panels. They do not use the words of the slots in which they are mounted. For details regarding data area allocations, refer to 2-2 and 3-2 *IR and DM Bit Allocations*.

With the C200H, do not mount an Analog I/O Unit in the two slots adjacent to the CPU. Doing so would prevent peripheral devices such as the Programming Console from being connected.

Special I/O Units cannot be used on a C200H Remote I/O Slave Rack if the Slave Rack is connected to different PC (i.e., C500, C1000H, or C2000H).

### Precautions

Be sure to turn off the power supply to the PC before installing or disconnecting Units or connecting lines.

To reduce the risk of malfunctioning due to electrical noise, wire input and output lines in separate ducts from high-voltage and power lines.

For further wiring precautions, refer to the respective sections on wiring for Analog Input Units and Analog Output Units.



# SECTION 2

## C200H-AD002 Analog Input Unit

This section provides the information required to install and operate a C200H-AD002 Analog Input Unit.

2-1	Before Operation .....
2-1-1	Nomenclature and Functions .....
2-1-2	Switch Settings .....
2-1-3	Wiring .....
2-2	Bit and DM Area Allocations .....
2-3	Functions and Programming .....
2-3-1	Conversion Prohibit Settings .....
2-3-2	Input Signal Range Setting .....
2-3-3	Conversion Data Type Setting .....
2-3-4	Square Root Function .....
2-3-5	Scaling Function .....
2-3-6	Mean Value Function .....
2-3-7	Peak Value Function .....
2-3-8	Limit Warning Function .....
2-3-9	Input Disconnection Detection Function .....
2-4	Data Setting and Programming Examples .....
2-4-1	Data Settings .....
2-4-2	Programming .....
2-5	Troubleshooting .....

## 2-1 Before Operation

### 2-1-1 Nomenclature and Functions

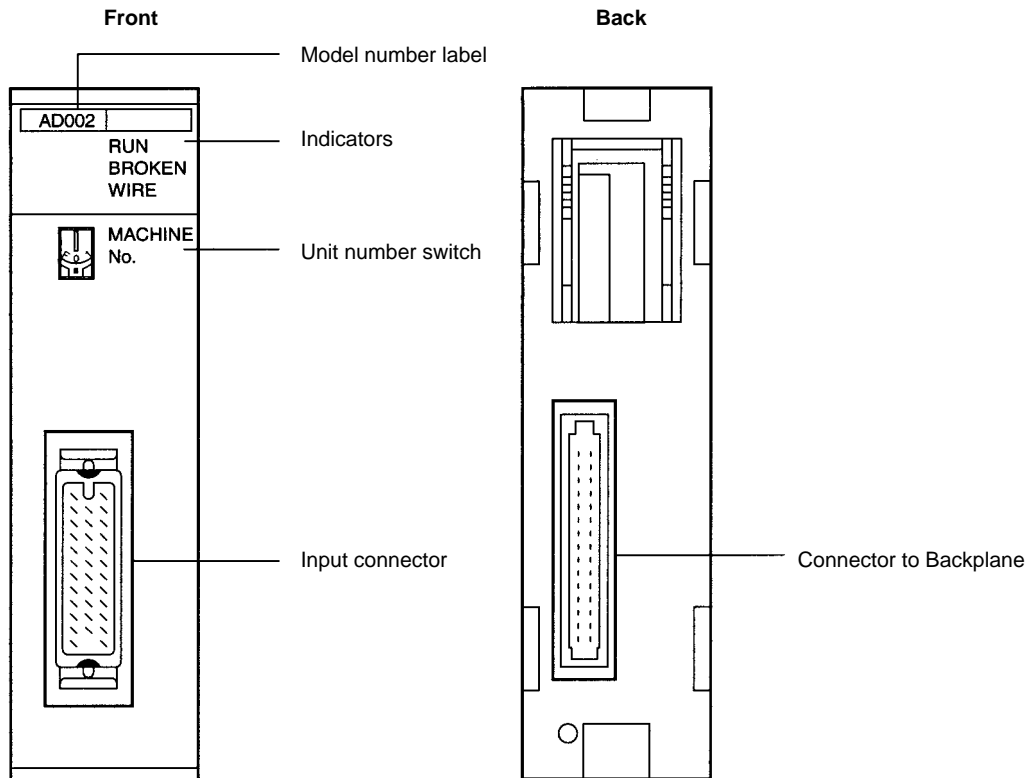

#### Indicators

Indicator	Color	Function
RUN	Green	Lit when the Analog Input Unit is operating correctly. If operation is not normal, this indicator turns OFF and Unit operation is stopped.
BROKEN WIRE	Red	Lit when an input signal wire is disconnected. This indicator operates only when the input range is set to 1 to 5 V/4 to 20 mA.

#### Functions

The following table briefly outlines the basic functions of the C200H-AD002. These functions are covered in more detail in *2-3 Functions and Programming*.

Function	Explanation
Conversion prohibit setting	Unnecessary conversion processing time can be reduced by disabling analog-to-digital conversion for unused inputs. Disabling conversion can also reduce the sampling period for each input.
Input range setting	The input range can be set for each input number according to the input signal level that is to be used.
Conversion data type setting	Sets whether the converted digital output is BCD or binary.
Square root	Converts quadratic data, such as thermocouple input, to linear data.
Scaling	Converts an analog input signal to a preset range of BCD data for output.
Mean value	Sums the sampling data for the specified number of samples, eliminates the minimum and maximum values, calculates the mean value from the remaining values, and outputs that value.
Peak value	Holds the maximum values for A/D conversion data, scaling data, mean data, and square root data, and outputs them as output data.
Limit warning	The Warning Flag is turned ON if the A/D conversion data, scaling data, mean data, or square root data exceeds the specified upper- or lower-limit values.
Disconnection detection	The Disconnection Detection Flag is turned ON and the BROKEN WIRE indicator is lit if the input signal wire becomes disconnected when 1 to 5 V/4 to 20 mA are set.

## 2-1-2 Switch Settings

### Unit Number Switch

The unit number (MACHINE No.) is the only setting necessary on the Analog Input Unit. Always turn off the power before setting the unit number. Use a flat-blade screwdriver, being careful not to damage the slot in the screw. Be sure not to leave the switch midway between settings.

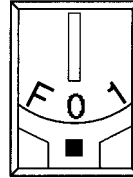

Switch setting	Unit number	IR words	DM words
0	Unit #0	IR 100 to 109	DM 1000 to 1043
1	Unit #1	IR 110 to 119	DM 1100 to 1143
2	Unit #2	IR 120 to 129	DM 1200 to 1243
3	Unit #3	IR 130 to 139	DM 1300 to 1343
4	Unit #4	IR 140 to 149	DM 1400 to 1443
5	Unit #5	IR 150 to 159	DM 1500 to 1543
6	Unit #6	IR 160 to 169	DM 1600 to 1643
7	Unit #7	IR 170 to 179	DM 1700 to 1743
8	Unit #8	IR 180 to 189	DM 1800 to 1843
9	Unit #9	IR 190 to 199	DM 1900 to 1943
A	Unit #10	IR 400 to 409	DM 2000 to 2043
B	Unit #11	IR 410 to 419	DM 2100 to 2143
C	Unit #12	IR 420 to 429	DM 2200 to 2243
D	Unit #13	IR 430 to 439	DM 2300 to 2343
E	Unit #14	IR 440 to 449	DM 2400 to 2443
F	Unit #15	IR 450 to 459	DM 2500 to 2543

- Note**
1. The unit number setting switch is factory set to 0.
  2. If two or more Special I/O Units are assigned the same unit number, an I/O UNIT OVER error will be generated and the PC will not operate.
  3. Make the unit number settings with the power turned off to the PC. If the settings are made with the power on, they will not go into effect until either the power is turned off and then on again or the Special I/O Unit Restart Flag (AR0100 to AR0109) is turned ON and then OFF again.
  4. The unit number can be set to between A and F Hex (10 to 15 decimal) only when a C200H-AD002 with a lot number □□16 or later (January 1996 or later) is used with a C200HG-CPU53/CPU63 or C200HX-CPU54/CPU64 CPU Unit.

## 2-1-3 Wiring

### Compatible Connector

One MR-34LFG Connector Set is included with each Unit. The set includes an MR-34FG Connector and MR-34L Cover made by Honda Communications.

Pin Allocation

Pin no.	Name		Pin no.	Name	Pin no.	Name	
12	Common (-)	Input 7	---	---	34	Common (-)	Input 8
11	Current input (+)		---	---	33	Current input (+)	
10	Voltage/Current input (+)		22	Analog ground (AG)	32	Voltage/Current input (+)	
9	Common (-)	Input 5	21	Shield	31	Common (-)	Input 6
8	Current input (+)		20	Shield	30	Current input (+)	
7	Voltage/Current input (+)		19	Shield	29	Voltage/Current input (+)	
6	Common (-)	Input 3	18	Shield	28	Common (-)	Input 4
5	Current input (+)		17	Shield	27	Current input (+)	
4	Voltage/Current input (+)		16	Shield	26	Voltage/Current input (+)	
3	Common (-)	Input 1	15	Shield	25	Common (-)	Input 2
2	Current input (+)		14	Shield	24	Current input (+)	
1	Voltage/Current input (+)		13	Frame ground (FG)	23	Voltage/Current input (+)	

- Note**
1. Short the current input (+) and voltage/current input (+) terminals when using a current input.
  2. All of the shield terminals (terminals 14 through 21) are shorted within the Unit. Wire each input's shield wire to any of these terminals.

Input Wiring Diagram

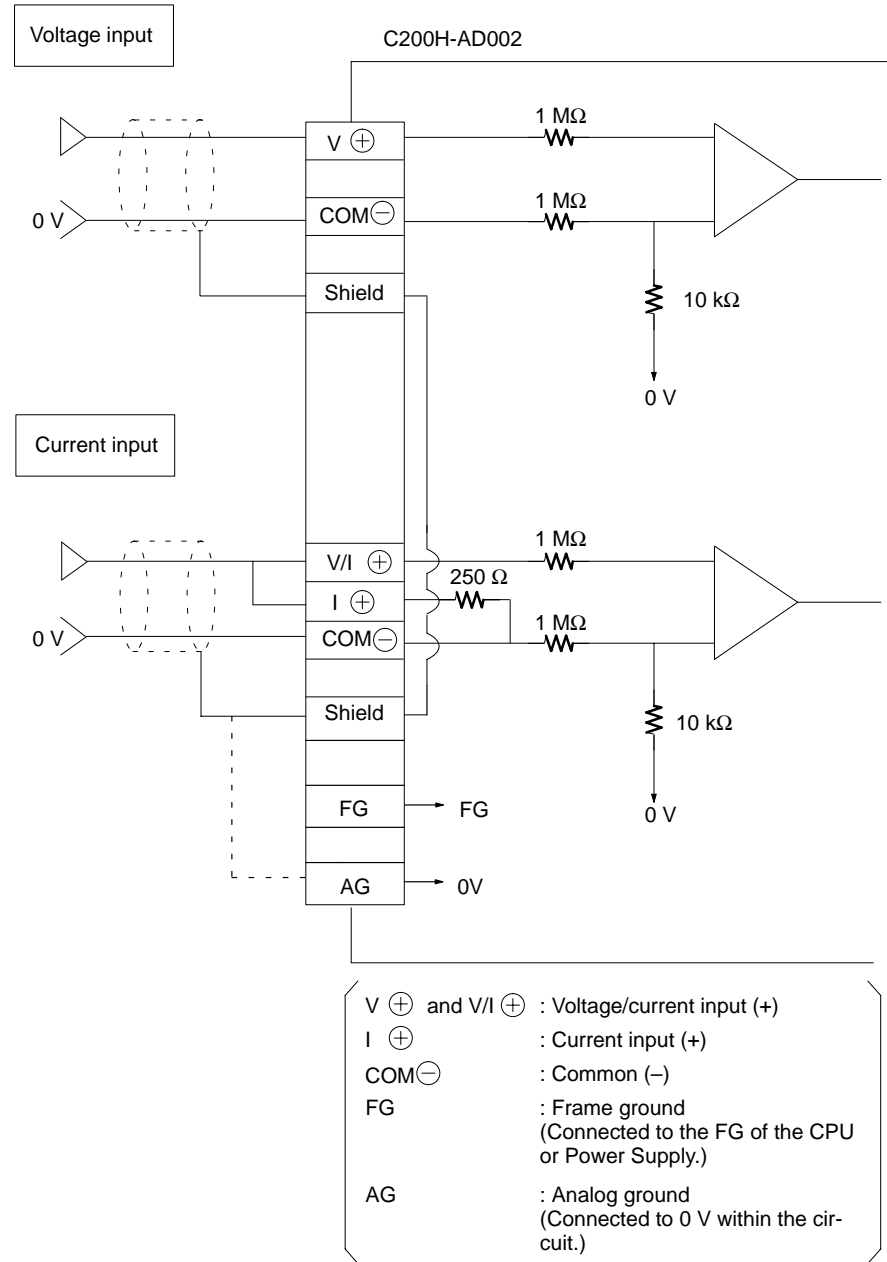

**Note** The AG terminal is a ground terminal for the analog input. Do not connected it to a frame ground.

**Wiring Methods**

Use the connectors provided with the Unit to wire input lines. (Connector: MR-34FG; Cover: MR-34L; both manufactured by Honda Communications; Connector/Cover Set: MR-34LFG).

Be sure to tighten the lock screws whenever attaching the connector to the Unit. Use wires with a diameter of 0.3 mm<sup>2</sup> maximum.

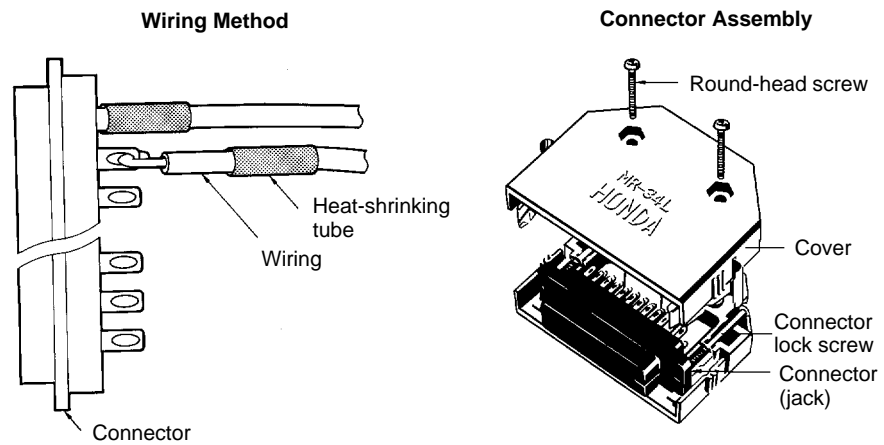

Do not forget to connect one of cable shield terminals to the FG terminal.

Do not remove the protective seal from the Unit until wiring has been completed. This seal will prevent wire clippings and other debris from entering the Unit and possibly preventing proper operation. Always remove this seal before operation. If the seal is left in place, the Unit may overheat, possibly causing improper operation or damage to the Unit.

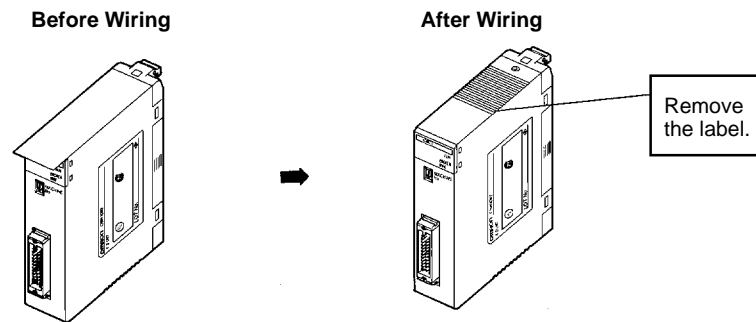

**Input Wiring Considerations**

When wiring inputs, apply the following points to avoid noise interference and optimize Analog Input Unit performance.

- Use shielded twisted-pair cable for external connections and power lines.
- Route input cables separately from the AC cable, and do not run the Unit's cables near a main circuit cable, high voltage cable, or a non-PC load cable.
- Be sure to install surge-absorbing diodes or surge absorbers for inductive loads (relays, solenoids, electromagnetic valves, etc.) They should be installed right next to relays and solenoids. Use surge-absorbing diodes with a dielectric strength of at least five times the circuit voltage.

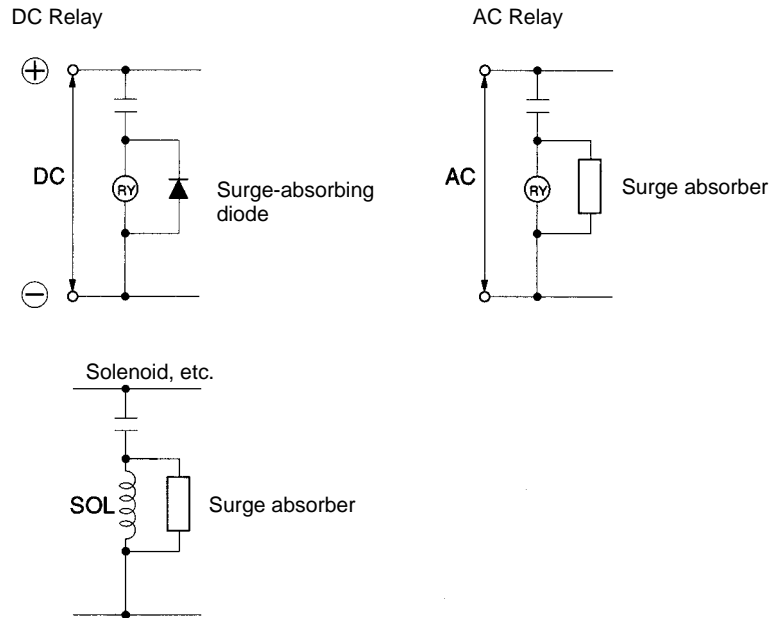

- If there is noise interference from power lines (if, for example, the power supply is shared with electrical welding devices or electrical discharge machines, or if there is a high-frequency generation source nearby) install a noise filter at the power supply input area.
- Connect to a ground of 100 Ω or less, with as heavy a wire as possible (i.e., at least 1.25 mm<sup>2</sup>).

## 2-2 Bit and DM Area Allocations

### IR Area Allocation

The Analog Input Units are allocated ten words each from the portion of the IR area (IR 100 to IR 199) that is reserved for Special I/O Units. The words that are allocated a particular Analog Input Unit depend on the setting of the unit number on the front panel of the Unit. Those ten words are then reserved as an I/O refresh data area, and the bits that comprise that area are refreshed with every I/O refresh cycle by the PC.

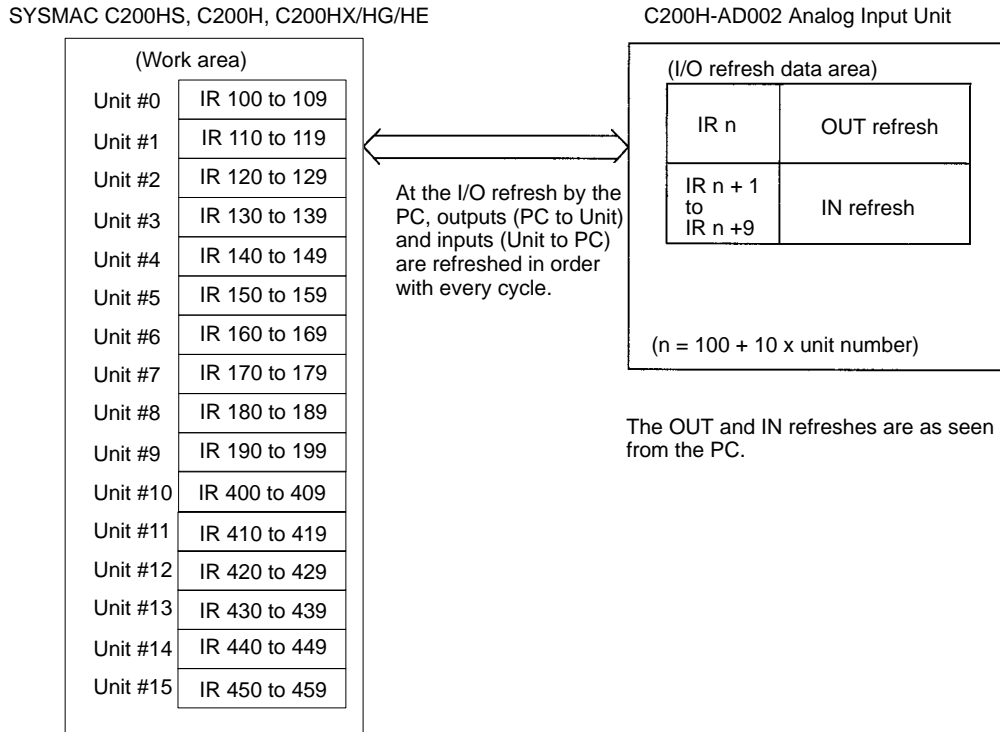

- Note**
1. The unit number that is set for an Analog Input Unit must not be used for any other Special I/O Unit. If the same unit number is set more than once, an I/O UNIT OVER error will be generated and operation will be stopped.
  2. The unit number can be set to between A and F Hex (10 to 15 decimal) only when a C200H-AD002 with a lot number □□16 or later (January 1996 or later) is used with a C200HG-CPU53/CPU63 or C200HX-CPU54/CPU64 CPU Unit.



DM Area Allocation

SYSMAC C200HS, C200H, C200HX/HG/HE

C200H-AD002 Analog Input Unit

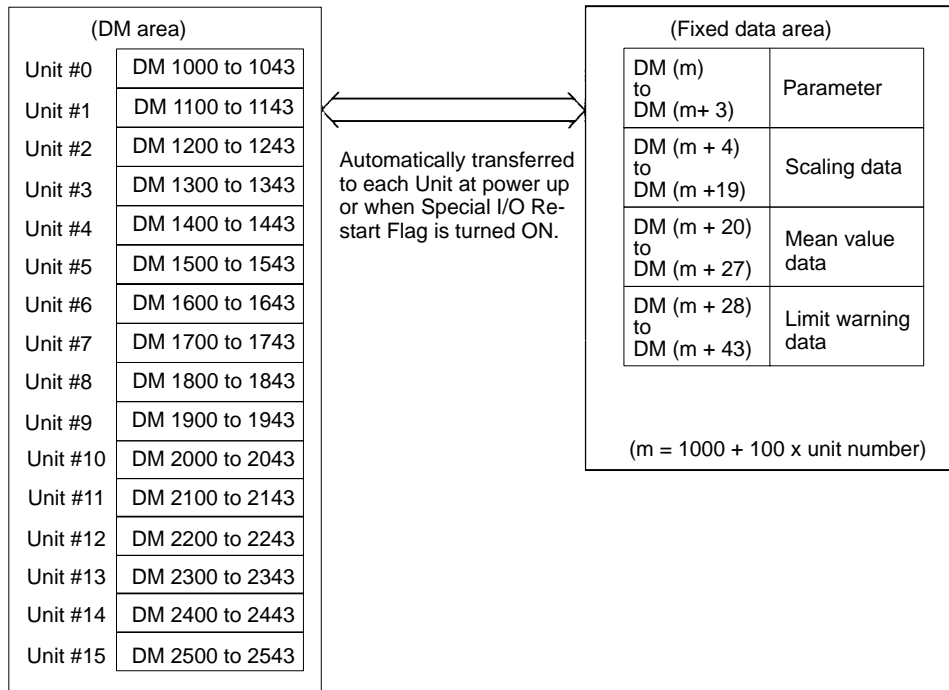

(For more information regarding DM area allocation, refer to *DM Allocations* at the end of this section.)

**Note** The unit number can be set to between A and F Hex (10 to 15 decimal) only when a C200H-AD002 with a lot number □□16 or later (January 1996 or later) is used with a C200HG-CPU53/CPU63 or C200HX-CPU54/CPU64 CPU Unit.

IR Allocations

I/O	Wd (IR)	Bit															
		15	14	13	12	11	10	09	08	07	06	05	04	03	02	01	00
Out	n	0				0				Peak value execution							
										Input 8	Input 7	Input 6	Input 5	Input 4	Input 3	Input 2	Input 1
In	n+1	Sign	Input 1 A/D conversion data or processing data														
	n+2	Sign	Input 2 A/D conversion data or processing data														
	n+3	Sign	Input 3 A/D conversion data or processing data														
	n+4	Sign	Input 4 A/D conversion data or processing data														
	n+5	Sign	Input 5 A/D conversion data or processing data														
	n+6	Sign	Input 6 A/D conversion data or processing data														
	n+7	Sign	Input 7 A/D conversion data or processing data														
	n+8	Sign	Input 8 A/D conversion data or processing data														
	n+9		Limit warning								Disconnection detection						
		Input 8	Input 7	Input 6	Input 5	Input 4	Input 3	Input 2	Input 1	Input 8	Input 7	Input 6	Input 5	Input 4	Input 3	Input 2	Input 1

Unit numbers 0 to 9: n = 100 + 10 x unit number

Unit numbers 10 to 15: n = 400 + 10 x (unit number - 10)

A/D Conversion Data

Input range	Binary data	BCD data
0 to 10 V, 1 to 5 V, or 4 to 20 mA	0000 to 0FA0	0000 to 4000
-10 to 10 V	87D0 to 8001, 0000 to 07D0 (-07D0 to -0001, 0000 to 07D0)	A000 to 8001, 0000 to 2000 (-2000 to -0001, 0000 to 2000)

**Note** When the input range is set to -10 V to +10 V, the 15<sup>th</sup> bit indicates the sign. A bit status of 0 indicates “+” and a bit status of 1 indicates “-.” There is no sign bit when the scaling or square root function is being executed.

**Processing Data**

When scaling, mean value processing, peak value, or square root calculation is executed, the resulting data is output.

**Note** When scaling is executed, it is set in IR words n+1 through n+8 in BCD.

**IR Area Contents: Outputs**

Address		Item	Contents
Word (IR)	Bit		
n	15 to 08	---	Not used. Set these bits to 00 (OFF).
	07 to 00	Peak Value ON Bits	Turn these bits to 1 (ON) to execute the peak value function for the corresponding input. Bits 00 through 07 correspond to inputs 1 through 8. Refer to 2-3-7 Peak Value Function for more details.

**IR Area Contents: Inputs**

Word (IR)	Bit	Item	Contents
n+1	15 to 00	Input 1 A/D conversion data or processing data	The A/D conversion data is set here for each input. The conversion data range is as follows when the input signal range is set to 0 to 10 V, 1 to 5 V, or 4 to 20 mA: BCD data: 0000 to 4000 Binary data: 0000 to 0FA0 The conversion data range is as follows when the input signal range is set to -10 to 10 V: BCD data: A000 to 8001, 0000 to 2000 Binary data: 87D0 to 8001, 0000 to 07D0 When the input range is set to -10 V to +10 V, the 15 <sup>th</sup> bit indicates the sign. A bit status of 0 indicates “+” and a bit status of 1 indicates “-.” (There is no sign bit when the scaling or square root function is being executed.) The processing results for the scaling, mean value, peak value, and square root functions are output here when those functions are being executed.
n+2	15 to 00	Input 2 A/D conversion data or processing data	
n+3	15 to 00	Input 3 A/D conversion data or processing data	
n+4	15 to 00	Input 4 A/D conversion data or processing data	
n+5	15 to 00	Input 5 A/D conversion data or processing data	
n+6	15 to 00	Input 6 A/D conversion data or processing data	
n+7	15 to 00	Input 7 A/D conversion data or processing data	
n+8	15 to 00	Input 8 A/D conversion data or processing data	
n+9	15 to 08	Limit warning	
	07 to 00	Disconnection detection	These bits are turned ON to indicate that a disconnection or broken wire has occurred in the corresponding input. Bits 00 through 07 correspond to inputs 1 through 8.

Unit numbers 0 to 9: n = 100 + 10 x unit number

Unit numbers 10 to 15: n = 400 + 10 x (unit number - 10)

**DM Allocations**

DM word	Bit															
	15	14	13	12	11	10	09	08	07	06	05	04	03	02	01	00
m	0				0	0	Limit warning mode	Data type setting	Conversion prohibit setting							
m+1	Input signal range (00 specifies -10 to +10 V, 01 specifies 0 to 10 V, and 10 specifies 1 to 5 V/4 to 20 mA.)															
m+2	Scaling execution								Mean value execution							
	Input 8	Input 7	Input 6	Input 5	Input 4	Input 3	Input 2	Input 1	Input 8	Input 7	Input 6	Input 5	Input 4	Input 3	Input 2	Input 1
m+3	Square root execution								Limit warning execution							
	Input 8	Input 7	Input 6	Input 5	Input 4	Input 3	Input 2	Input 1	Input 8	Input 7	Input 6	Input 5	Input 4	Input 3	Input 2	Input 1

DM word	Bit															
	15	14	13	12	11	10	09	08	07	06	05	04	03	02	01	00
m+4	Input 1 scaling: lower-limit value															
m+5	Input 1 scaling: upper-limit value															
m+6	Input 2 scaling: lower-limit value															
m+7	Input 2 scaling: upper-limit value															
m+8	Input 3 scaling: lower-limit value															
m+9	Input 3 scaling: upper-limit value															
m+10	Input 4 scaling: lower-limit value															
m+11	Input 4 scaling: upper-limit value															
m+12	Input 5 scaling: lower-limit value															
m+13	Input 5 scaling: upper-limit value															
m+14	Input 6 scaling: lower-limit value															
m+15	Input 6 scaling: upper-limit value															
m+16	Input 7 scaling: lower-limit value															
m+17	Input 7 scaling: upper-limit value															
m+18	Input 8 scaling: lower-limit value															
m+19	Input 8 scaling: upper-limit value															
m+20	Input 1 mean value processing: number of samples															
m+21	Input 2 mean value processing: number of samples															
m+22	Input 3 mean value processing: number of samples															
m+23	Input 4 mean value processing: number of samples															
m+24	Input 5 mean value processing: number of samples															
m+25	Input 6 mean value processing: number of samples															
m+26	Input 7 mean value processing: number of samples															
m+27	Input 8 mean value processing: number of samples															
m+28	Input 1 limit warning: lower-limit value															
m+29	Input 1 limit warning: upper-limit value															
m+30	Input 2 limit warning: lower-limit value															
m+31	Input 2 limit warning: upper-limit value															
m+32	Input 3 limit warning: lower-limit value															
m+33	Input 3 limit warning: upper-limit value															
m+34	Input 4 limit warning: lower-limit value															
m+35	Input 4 limit warning: upper-limit value															
m+36	Input 5 limit warning: lower-limit value															
m+37	Input 5 limit warning: upper-limit value															
m+38	Input 6 limit warning: lower-limit value															
m+39	Input 6 limit warning: upper-limit value															
m+40	Input 7 limit warning: lower-limit value															
m+41	Input 7 limit warning: upper-limit value															
m+42	Input 8 limit warning: lower-limit value															
m+43	Input 8 limit warning: upper-limit value															

## DM Contents

DM word(s)	Bits	Item	Data contents
m	15 to 10	---	Not used.
	09	Limit warning mode	Sets the operating mode for the limit warning function. This setting applies to all 8 inputs. 0: Mode 1 (normal warning) 1: Mode 2 (sequence warning) Refer to 2-3-8 <i>Limit Warning Function</i> for more details.
	08	Conversion data type	Sets the data type of the conversion data to binary or BCD. This setting applies to all 8 inputs. 0: Binary 1: BCD
	07 to 00	Conversion prohibit setting	Turn these bits turned ON to disable A/D conversion for the corresponding input. Bits 00 through 07 correspond to inputs 1 through 8. 0: Conversion enabled 1: Conversion disabled
m+1	15 and 14	Input signal range for input 8	Each pair of bits sets the input signal range for the corresponding input, as follows. (The first bit is the higher bit.) 00: -10 V to +10 V 01: 0 to 10 V 10: 1 to 5 V/4 to 20 mA 11: Not used.
	13 and 12	Input signal range for input 7	
	11 and 10	Input signal range for input 6	
	09 and 08	Input signal range for input 5	
	07 and 06	Input signal range for input 4	
	05 and 04	Input signal range for input 3	
	03 and 02	Input signal range for input 2	
	01 and 00	Input signal range for input 1	
m+2	15 to 08	Scaling execution	Turn these bits turned ON to execute the scaling function for the corresponding input. Bits 08 through 15 correspond to inputs 1 through 8. 0: Scaling function won't be executed. 1: Scaling function will be executed. Refer to 2-3-5 <i>Scaling Function</i> for more details.
	07 to 00	Mean value execution	Turn these bits turned ON to execute the mean value function for the corresponding input. Bits 00 through 07 correspond to inputs 1 through 8. 0: Mean value function won't be executed. 1: Mean value function will be executed. Refer to 2-3-6 <i>Mean Value Function</i> for more details.
m+3	15 to 08	Square root execution	Turn these bits turned ON to execute the square root function for the corresponding input. Bits 08 through 15 correspond to inputs 1 through 8. 0: Square root function won't be executed. 1: Square root function will be executed. Refer to 2-3-4 <i>Square Root Function</i> for more details.
	07 to 00	Limit warning execution	Turn these bits turned ON to execute the limit warning function for the corresponding input. Bits 00 through 07 correspond to inputs 1 through 8. 0: Limit warning function won't be executed. 1: Limit warning function will be executed. Refer to 2-3-8 <i>Limit Warning Function</i> for more details.
m+4 to m+19	15 to 00	Scaling data	The scaling data (upper and lower limits) is set in BCD (0000 to 9999), using two words for each input. Set the lower limit in the first of the two words and the upper limit in the second, and make sure that the lower limit is smaller than the upper limit. Refer to 2-3-5 <i>Scaling Function</i> for more details.

DM word(s)	Bits	Item	Data contents
m+20 to m+27	15 to 00	Number of terms for calculating mean value	The number of samples to be taken for calculating the mean value is set in BCD (0003 to 9999) for each input. DM words m+20 through m+27 correspond to inputs 1 through 8. Refer to 2-3-6 <i>Mean Value Function</i> for more details.
m+28 to m+43	15 to 00	Limit warning data	The limit warning data (upper and lower limits) is set in BCD using two words for each input. Set the lower limit in the first of the two words and the upper limit in the second, and make sure that the lower limit is smaller than the upper limit. The setting range is 0000 to 4000. (The scaling data's upper and lower limits are used when the scaling function is being executed.) Refer to 2-3-8 <i>Limit Warning Function</i> for more details.

## 2-3 Functions and Programming

The C200H-AD002 Analog Input Unit provides nine functions:

- 1, 2, 3...
1. Conversion prohibit settings
  2. Input signal range settings
  3. Conversion data type setting
  4. Square root function
  5. Scaling function
  6. Mean value processing function
  7. Peak value function
  8. Limit warning function
  9. Disconnection detection function  
(This function can be used with the 1 to 5 V/4 to 20 mA input range only.)

These functions are set using Unit switches and Peripheral Devices, such as a Programming Console. The words allocated to the Unit in the DM Area (DM m to DM m+43) cannot be written from user program and all data set in these words must be written from a Peripheral Device.

When inputting data from a Programming Console, use the operations to change present values. When inputting from the SSS (SYSMAC Support Software), use the DM editing operations.

The data set in the DM area is transferred to the Analog Input Unit when either of the following steps is taken. Be sure to perform one or the other of these steps whenever new data has been set or data has been changed.

- Turning ON → OFF → ON the power to the C200H, C200HS, C200HX/HG/HE CPU.
- Turning OFF → ON the Restart Bit allocated to the Unit as a Special I/O Unit (C200H/C200HS: AR 0100 to 0109, C200HX/HG/HE: SR 28100 to 28115).

The above functions 3 to 8 can be used at the same time. Data will be processed in the following sequence and the final results will be output to words n+1 to n+8: analog-to-digital conversion → square root → scaling → mean value → peak value.

### 2-3-1 Conversion Prohibit Settings

**Function**

The A/D conversion processing period for the used inputs can be reduced by stopping conversion for unused inputs.

The data is fixed at 0000 for inputs with the conversion prohibit setting.

**Setting Method**

The conversion prohibit setting is made in bits 00 to 07 of DM word m. Set the corresponding bit to “1” to prohibit conversion for that input.

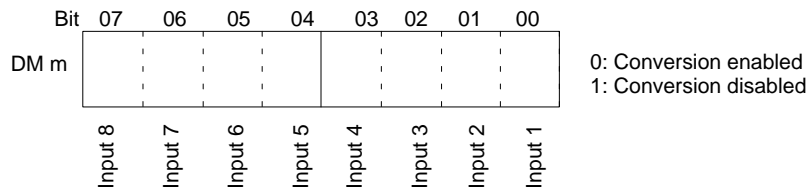

**Sampling Period**

The “sampling period” is the amount of time between A/D conversion processing for a given input. The sampling period for this Unit can be determined from the following equation:

$$\text{Sampling period} = 4 \text{ ms} + (\text{number of enabled inputs}) \times 2.5 \text{ ms}$$

The base sampling period of 4 ms excludes effects such as temperature drift. This processing is performed every time after A/D conversion has been performed for the last enabled input.

Stopping conversion for unused inputs reduces the number of enabled inputs and the sampling period, as shown in the following table.

Number of enabled inputs	Sampling period
1	6.5 ms
2	9.0 ms
3	11.5 ms
4	14.0 ms
5	16.5 ms
6	19.0 ms
7	21.5 ms
8	24.0 ms

**Additional Information**

The following amount of time is required to read the conversion data to the CPU.

$$\begin{aligned} \text{Min. time required} &= (\text{sampling period}) + (\text{cycle time}) \\ \text{Max. time required} &= (\text{sampling period}) + (\text{cycle time}) \times 2 \end{aligned}$$

**2-3-2 Input Signal Range Setting**

**Function**

Sets the input signal range to match the input signal being used for each input.

**Setting Method**

The input signal range setting for each input is made with two bits in DM word m+1. Set the corresponding pair of bits to the desired value for that input.

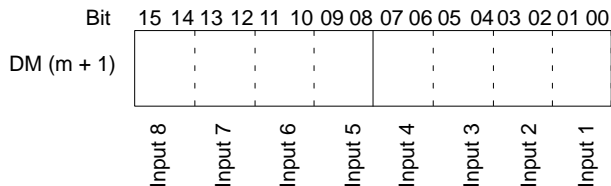

Bit		Input signal range
Leftmost bit	Rightmost bit	
0	0	-10 to +10 V
0	1	0 to +10 V
1	0	+1 to +5 V/+4 to +20 mA
1	1	Not used.

**Example**

This example shows how to set DM word m+1 to set the following input signal ranges.

Inputs	Input signal range	Bit settings
Inputs 1 to 4	+1 to +5 V	10
Inputs 5 and 6	-10 to +10 V	00
Inputs 7 and 8	0 to +10 V	01

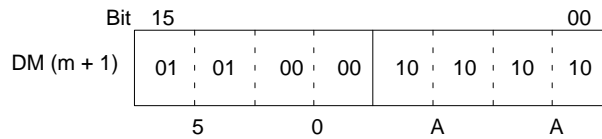

Set DM word m+1 to "50AA" to set the desired input signal ranges.

### 2-3-3 Conversion Data Type Setting

**Function**

Sets whether the digital conversion data is output in binary or BCD. The digital data is output to IR words n+1 through n+8.

The scaling and square root functions can process BCD data only, so the data type setting is ignored when these functions are being used.

**Setting Method**

Set the data type with bit 8 of DM word m.

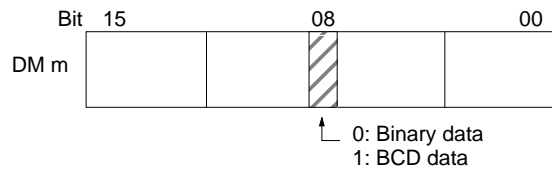

**A/D Conversion Data**

The following table shows the range of data that is output to IR words n+1 through n+8.

Input range	Binary data	BCD data
0 to +10 V, +1 to +5 V, +4 to +20 mA	0000 to 0FA0	0000 to 4000
-10 to +10 V	87D0 to 8001, 0000 to 07D0 (-07D0 to -0001, 0000 to 07D0)	A000 to 8001, 0000 to 2000 (-2000 to -0001, 0000 to 2000)

**Note** When the input range is set to -10 V to +10 V, the 15<sup>th</sup> bit indicates the sign. A bit status of 0 indicates "+" and a bit status of 1 indicates "-." There is no sign bit when the scaling or square root function is being executed.

**Binary Data Conversion**

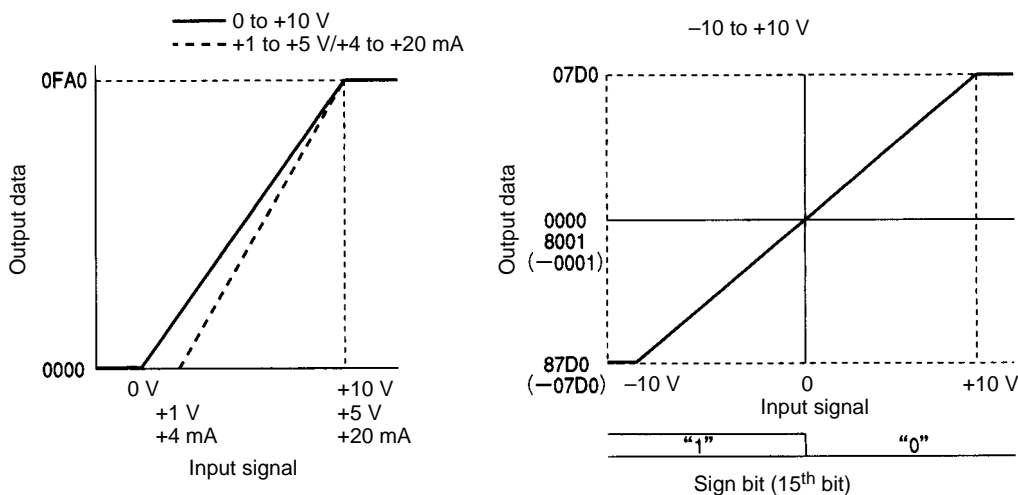

BCD Data Conversion

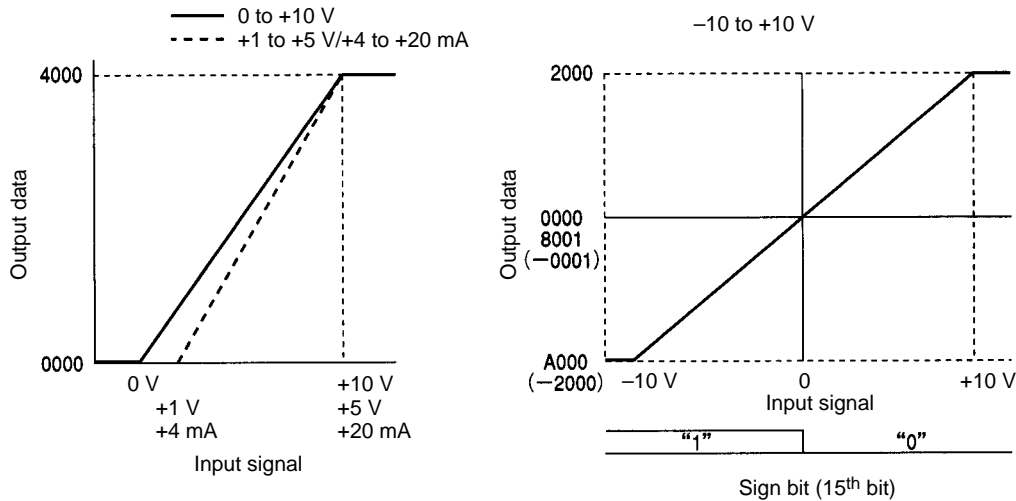

- Note**
1. The maximum digital output value will be used if the analog input signal exceeds the maximum value of the specified input signal range (+10 V or +5 V/+20 mA) and the minimum digital output value will be used if the analog input signal falls below the minimum value of the specified input signal range (0 V, +1 V/+4 mA, or -10 V).
  2. The digital output value will be 0000 when the input signal range is set to -10 to +10 V and the analog input signal is 0 V. The sign bit will be 0, and there is no output value of 8000.

2-3-4 Square Root Function

Function

Converts quadratic input data, such as data from a thermocouple input, to linear data (0000 to 4000 BCD) and outputs the converted data.

This function can be used at the same time as other functions. When the square root function is used together with the scaling or mean value functions, the scaling or mean value processing is performed after the square root processing.

This function operates on BCD data only, so the conversion data type setting is ignored.

Setting Method

The square root function is set with bits 08 to 15 of DM word m+3. Set the corresponding bit to "1" to enable the square root function for that input.

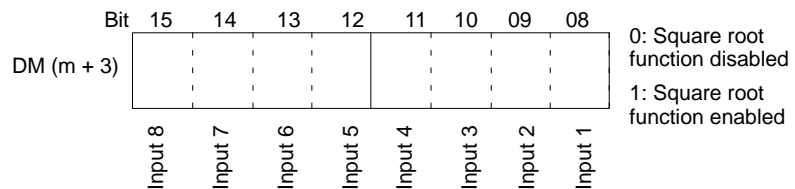

Square Root Calculation

The square root function is performed with the following equation and the decimal portion of the result is truncated.

$$\text{Square root data} = \sqrt{4000 \times \text{input data (BCD conversion data)}}$$

When the input signal range is set to -10 to +10 V, calculate the input data (BCD conversion data) with -10 V as 0000 and +10 V as 4000.



### 2-3-5 Scaling Function

The scaling function converts the digital output values to the scale defined by the specified lower-limit and upper-limit values, then outputs the scaled data. The lower-limit value is the digital output value corresponding to the minimum input value. The upper-limit value is the digital output value corresponding to the maximum input value.

Scaled data for each input is output in IR words n+1 through n+8.

This function operates on BCD data only, so the conversion data type setting is ignored. Except for the BCD limitation, the scaling function can be used with other functions.

#### Setting Method

Two settings must be made to use the scaling function. First, the scaling function must be enabled for the desired input(s), and then the upper- and lower-limit data must be set for those inputs.

- 1, 2, 3... 1. The scaling function is set with bits 08 to 15 of DM word m+2. Set the corresponding bit to "1" to enable the scaling function for that input.

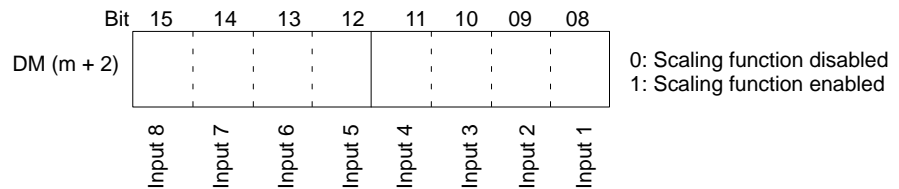

2. Set the upper and lower limits for each input in the corresponding pair of words in DM m+4 through DM m+19. The data must be BCD from 0000 to 9999 and the upper-limit value must be greater than the lower-limit value.

DM word	Data
m+4	Input 1 scaling: lower-limit value
m+5	Input 1 scaling: upper-limit value
m+6	Input 2 scaling: lower-limit value
m+7	Input 2 scaling: upper-limit value
m+8	Input 3 scaling: lower-limit value
m+9	Input 3 scaling: upper-limit value
m+10	Input 4 scaling: lower-limit value
m+11	Input 4 scaling: upper-limit value
m+12	Input 5 scaling: lower-limit value
m+13	Input 5 scaling: upper-limit value
m+14	Input 6 scaling: lower-limit value
m+15	Input 6 scaling: upper-limit value
m+16	Input 7 scaling: lower-limit value
m+17	Input 7 scaling: upper-limit value
m+18	Input 8 scaling: lower-limit value
m+19	Input 8 scaling: upper-limit value

#### Scaling Calculation

The scaling calculation is made with the following equation using the preset upper and lower-limit values for the input. The decimal portion of the result is truncated.

$$\text{Scaled data} = \text{input data (BCD conversion data)} \times \frac{\text{upper limit} - \text{lower limit}}{4000} + \text{lower limit}$$

When the input signal range is set to -10 to +10 V, calculate the input data (BCD conversion data) with -10 V as 0000 and +10 V as 4000.

- Note**
1. The resolution is fixed at 1/4000 if the (upper limit – lower limit) term is greater than 4000.
  2. The resolution will be lower if the (upper limit – lower limit) term is less than 4000. For example, the resolution will be 1/2000 if the upper limit – lower limit = 2000.
  3. The scaling calculation won't be performed if the DM words don't contain BCD data or the upper-limit data  $\leq$  lower-limit data.
  4. When the scaling function is executed, the conversion data type setting is ignored and the scaled data is output.

**Example 1**

Input signal range: 0 to +10 V  
 Lower limit: 1000  
 Upper limit: 9000

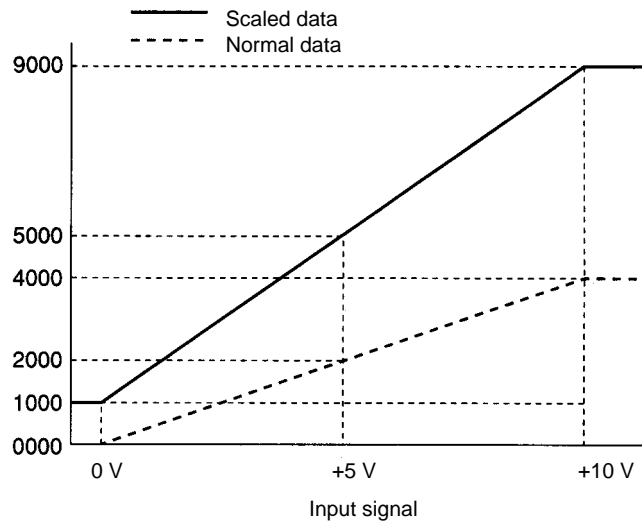

**Example 2**

Input signal range: -10 to +10 V  
 Lower limit: 1000  
 Upper limit: 7000

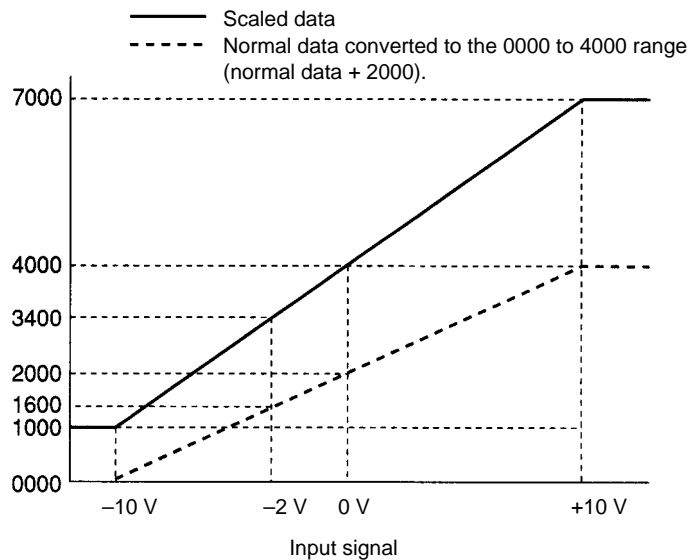

For example, the scaled data for -2 V is calculated as follows:

$$\text{BCD conversion value for } -2\text{ V} = \frac{(-2) - (-10)}{10 - (-10)} \times 4000 = \frac{8}{20} \times 4000 = 1600$$

$$-2\text{ V scaled data} = 1600 \times \frac{7000 - 1000}{4000} + 1000 = 3400$$

### 2-3-6 Mean Value Function

#### Function

The mean value function collects the specified number of data samples, discards the minimum and maximum values, calculates the mean value of the remaining samples and outputs the result.

The result for each input is output to its corresponding word in IR words n+1 through n+8.

The mean value function can be used in combination with other functions.

#### Setting Method

Two settings must be made to use the mean value function. First, the mean value function must be enabled for the desired input(s), and then the number of samples data must be set for those inputs.

- 1, 2, 3... 1. The mean value function is set with bits 00 to 07 of DM word m+2. Set the corresponding bit to "1" to enable the mean value function for that input.

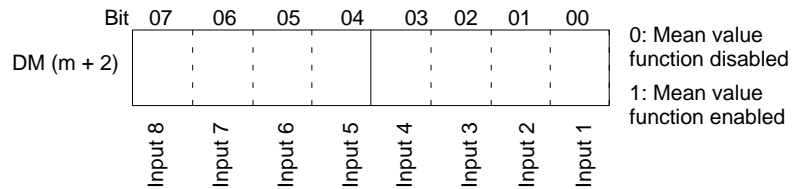

2. Set the number of samples for each input in the corresponding word in DM m+20 through DM m+27. The data must be BCD from 0003 to 9999.

DM word	Data
m+20	Input 1 mean value processing: number of samples
m+21	Input 2 mean value processing: number of samples
m+22	Input 3 mean value processing: number of samples
m+23	Input 4 mean value processing: number of samples
m+24	Input 5 mean value processing: number of samples
m+25	Input 6 mean value processing: number of samples
m+26	Input 7 mean value processing: number of samples
m+27	Input 8 mean value processing: number of samples

#### Mean Value Calculation and Sampling Period

The mean value is calculated using the equation below. The decimal portion of the result is truncated.

$$\text{Mean value} = \frac{\text{sum of the samples (except the min. and max. values)}}{\text{number of samples} - 2}$$

The sampling period between mean value calculations can be determined from the following equation:

$$\begin{aligned} \text{Sampling period} &= (\text{no. of samples}) \times (\text{sampling period per point}) \\ &= (\text{no. of samples}) \times (4\text{ ms} + (\text{no. of enabled inputs}) \times 2.5\text{ ms}) \end{aligned}$$

- Note**
1. The previous mean value result will be output while the mean value processing is being performed (including sample collection).
  2. After power is turned on, a value of 0000 will be output until the first mean value calculation is completed.
  3. The mean value calculation won't be performed if the data in DM words m+20 through m+27 isn't BCD data from 0003 to 9999.

### 2-3-7 Peak Value Function

**Function**

The peak value function holds the maximum output value for every input. This function can be used in combination with the scaling, mean value, and square root functions. These functions are performed in the following order:

A/D conversion → square root → scaling → mean value → peak value

The maximum value of the final result will be output to the corresponding word from IR n+1 through IR n+8.

The peak value function can be used in combination with other functions.

**Setting Method**

The peak value function is set with bits 00 to 07 of IR (n). Set the corresponding bit to “1” to enable the peak value function for that input.

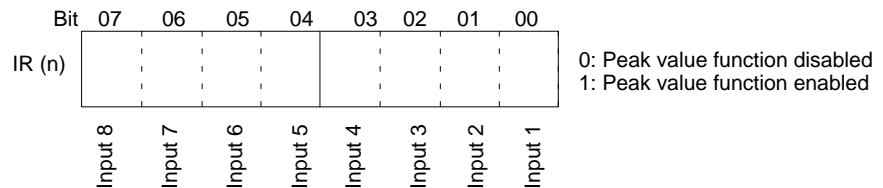

The peak value function will be executed for an input as long as its corresponding control bit is ON. The bits in IR (n) are output bits, so their status can be controlled from the program.

**Mean and Peak Values**

Data will be output as illustrated below when both the mean value and the peak value functions are used. In this example, mean value #2 will be output as the first peak value even if mean value #1 is larger because the Peak Value ON Bit was turned ON after mean value #1 was output.

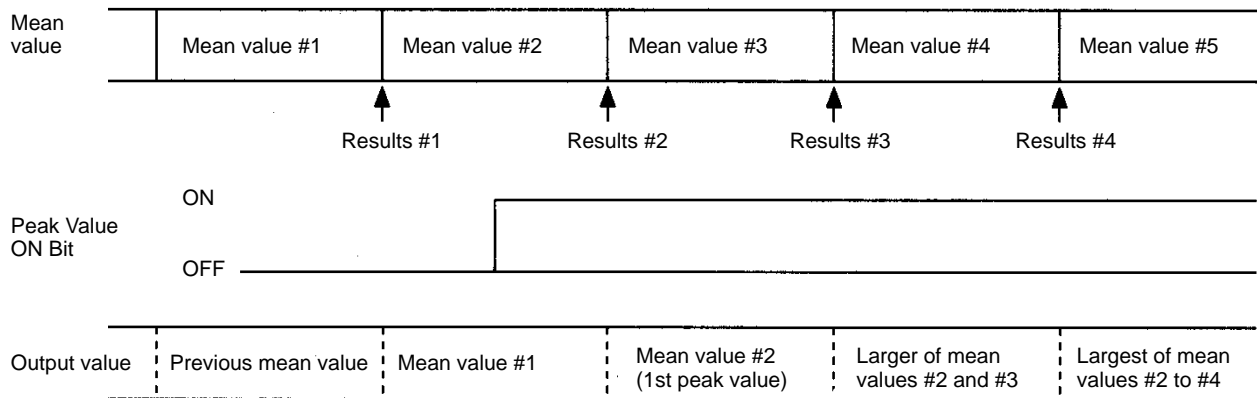

### 2-3-8 Limit Warning Function

**Function**

The limit warning function turns on a warning flag in IR n+9 when the output data for the corresponding input is outside of the preset range. Bits 08 through 15 of IR n+9 are the warning flags for inputs 1 through 8.

The limit warning applies to the final data output to words IR n+1 through IR n+8.

**Setting Method**

Three settings must be made to use the limit warning function. First, the limit warning mode must be set, then the limit warning function must be enabled for the desired input(s), and finally the upper- and lower-limit data must be set for those inputs.

- 1, 2, 3... 1. The limit warning mode is set with bit 09 of DM word m. This mode setting applies to all 8 inputs.

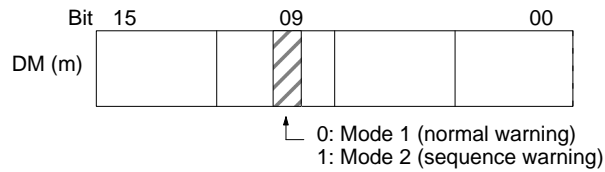

**Mode 1**

The output values are compared to the upper/lower limits from startup.

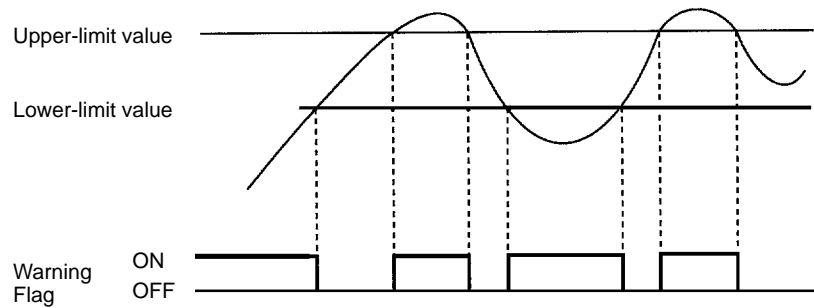

**Mode 2**

The output values are compared to the upper/lower limits after the output value enters the range between the lower and upper limits.

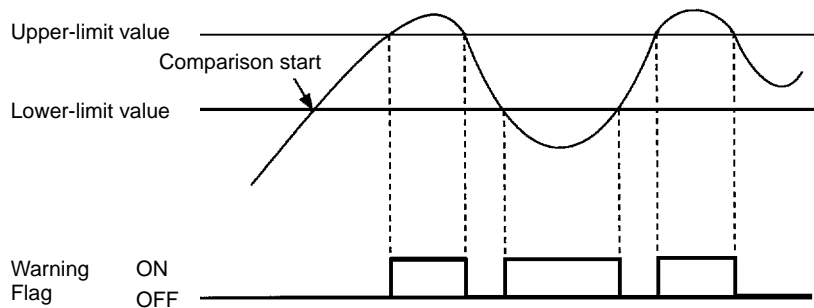

2. The limit warning function is enabled with bits 00 to 07 of DM word m+3. Set the corresponding bit to "1" to enable the limit warning function for that input.

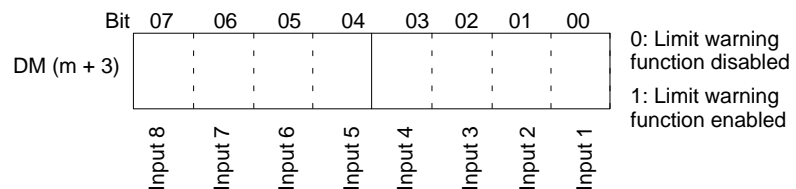

3. Set the upper and lower limits for each input in the corresponding pair of words in DM m+28 through DM m+43. The data must be BCD from 0000 to 4000 and the upper-limit value must be greater than the lower-limit value. The scaling function's upper/lower limits are used when the scaling function is being executed.

DM word	Data
m+28	Input 1 lower-limit warning data
m+29	Input 1 upper-limit warning data
m+30	Input 2 lower-limit value
m+31	Input 2 upper-limit value
m+32	Input 3 lower-limit value

DM word	Data
m+33	Input 3 upper-limit value
m+34	Input 4 lower-limit value
m+35	Input 4 upper-limit value
m+36	Input 5 lower-limit value
m+37	Input 5 upper-limit value
m+38	Input 6 lower-limit value
m+39	Input 6 upper-limit value
m+40	Input 7 lower-limit value
m+41	Input 7 upper-limit value
m+42	Input 8 lower-limit value
m+43	Input 8 upper-limit value

If the conversion data type setting (bit 08 of DM m) is binary, the output value will be converted to BCD for comparison.

When the input signal range is set to -10 to +10 V, calculate the input data with -10 V as 0000 and +10 V as 4000. (When the scaling function is being used, -10 V=lower-limit value and +10 V=upper-limit value.)

**Limit Warning Flags**

The corresponding Limit Warning Flag (bits 08 to 15 in IR n+9) will be turned ON if the output data in IR words n+1 through n+8 isn't within the range specified with the upper-/lower-limit values. The Limit Warning Flags don't indicate whether the upper or lower limit has been crossed.

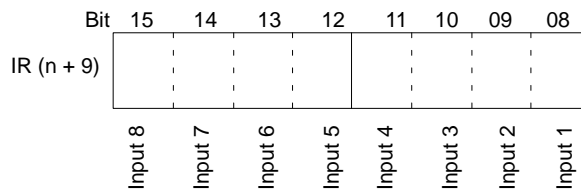

- Note**
1. The Limit Warning Flag won't be turned ON if the output data is outside of the specified range for less than one PC cycle.
  2. The limit warning function won't operate if the upper-/lower-limit values are outside of the acceptable setting range (0000 to 4000) or the lower-limit value is greater than the upper-limit value.

**2-3-9 Input Disconnection Detection Function**

**Function**

The Input Disconnect Flag (bits 00 through 07 of IR n+9) will be turned ON when the input signal level is less than 1 V/4 mA and the input signal range is set at 1 to 5 V/4 to 20 mA. The BROKEN WIRE indicator on the front of the Unit will light when one or more of the Input Disconnect Flags is ON.

**Input Disconnect Flags**

The Input Disconnect Flags are contained in in word IR n+9, as shown below.

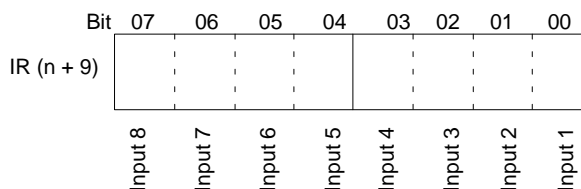

**Mean Value Processing and Disconnection Detection**

The following diagram shows how a disconnection detection affects the results (output data) produced by the mean value function.

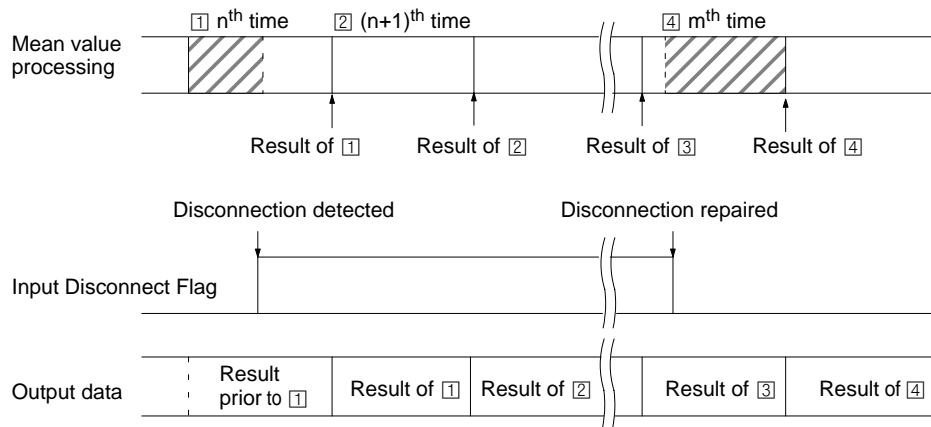

- Result of 1: Mean value of samples collected before disconnection (Samples collected in the shaded region. See note 1.)
- Result of 2: 0000 or the lower-limit value (when scaling is being executed)
- Result of 3: 0000 or the lower-limit value (when scaling is being executed)
- Result of 4: Mean value of samples collected after reconnection (Samples collected in the shaded region. See note 1.)

- Note**
1. The result of 2 is used if 2 or fewer samples are collected.
  2. The input disconnection detection function will operate only when the input's corresponding conversion prohibit bit is OFF (bits 00 to 07 of DM m). If an input isn't being used or isn't connected, its Input Disconnect Flag will be turned ON unless its conversion prohibit bit is turned ON.
  3. If a disconnection occurs while the limit warning function is being used, both the Input Disconnect Flag and the Limit Warning Flag will be turned ON.
  4. If a disconnection occurs while the peak hold function is being used, the peak value will be maintained.
  5. The disconnection detection function is valid only when the input signal range is set at 1 to 5 V/4 to 20 mA.

## 2-4 Data Setting and Programming Examples

### 2-4-1 Data Settings

The following settings are used in this example.

#### Basic Settings

Item	Setting
Unit number	0 (allocated words: IR 100 to IR 109 and DM 1000 to DM 1043)
Inputs used	Inputs 1 to 5 (The conversion prohibit bits for inputs 6 to 8 are turned ON.)
A/D conversion data	BCD

#### Detailed Settings

Item	Input 5	Input 4	Input 3	Input 2	Input 1
Input signal range	-10 to +10 V	0 to +10 V	4 to 20 mA	1 to 5 V	1 to 5 V
Scaling function	Lower limit	---	0400	1000	1000
	Upper limit	---	1000	5000	5000
Number of terms for mean value calculation	---	---	50	---	---
Square root function	---	---	---	---	Yes
Limit warning function	Mode	---	---	2	---
	Lower limit	---	---	1200	---
	Upper limit	---	---	4800	---

#### DM Area Settings

Data in the DM area is set using a computer running SSS, a Programming Console, or other Peripheral Device.

After setting the data, turn the PC ON → OFF → ON or turn AR 0100 (the Special I/O Unit Restart Bit) OFF → ON → OFF to initialize the Unit with the new settings.

DM word	Contents	Data
DM 1000	03E0	Limit warning mode (bit 09 = "1"), BCD (bit 08 = "1"), conversion prohibit (bits 05 to 07 = "1")
DM 1001	006A	Input signal range setting (00 00 00 00 01 10 10 10)
DM 1002	0704	Scaling function (bits 08 to 10 = "1"), mean value function (bit 02 = "1")
DM 1003	0102	Square root function (bit 08 = "1"), limit warning function (bit 01 = "1")
DM 1004	1000	Input 1 lower limit for scaling
DM 1005	5000	Input 1 upper limit for scaling
DM 1006	1000	Input 2 lower limit for scaling
DM 1007	5000	Input 2 upper limit for scaling
DM 1008	0400	Input 3 lower limit for scaling
DM 1009	1000	Input 3 upper limit for scaling
DM 1022	0050	Input 3 number of terms for mean value
DM 1030	1200	Input 2 limit warning function: lower limit
DM 1031	4800	Input 2 limit warning function: upper limit



## 2-4-2 Programming

### Reading Output Data

The converted data (or the results of calculations performed on it) can be read from the output words IR n+1 to IR n+8 and moved to other words in memory using MOV(21) and/or XFER(70). MOV(21) is used to move one word at a time and XFER(70) is used to move more than one word at a time.

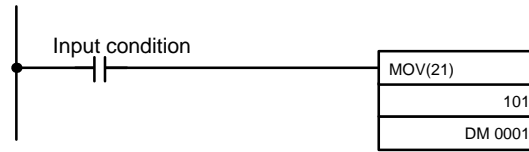

Moves the output data from IR 101 (input 1) to DM 0001.

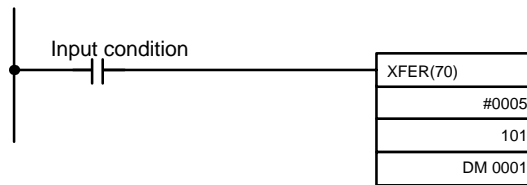

Moves the output data from IR 101 through IR 105 (inputs 1 through 5) to DM 0001 through DM 0005.

### Reading Output Data (-10 to +10 V Input Range)

The sign bit will be set to "1" when the input setting range is set to -10 to 10 V and the input signal is negative. To separate the sign bit and the actual voltage, use a program that masks the sign bit, as in the following example.

In this example, the A/D Unit's output data is displayed on a display device through the High-density Output Unit with unit number 2.

CN1 (IR 120): Actual data

CN2 (IR 121): Signed data (Bit IR 12100 indicates the sign.)

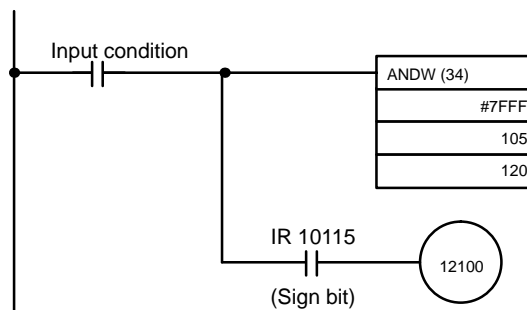

Moves the actual voltage data to IR 120 (CN1).

Moves the sign data to IR 12100 (CN2).

### Peak Value Setting

The following example shows how to set the peak value function for input 4.

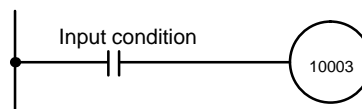

## 2-5 Troubleshooting

### Error Detection

When an error occurs in an input or in the Unit itself, the error is indicated by an output to a flag in the IR, SR, or AR area. The following tables show the various errors that may occur, along with their probable causes and remedies.

Unit error	Probable causes and operations	Possible remedies
Disconnection error	<ul style="list-style-type: none"> <li>• <b>Causes of error</b> <ul style="list-style-type: none"> <li>• Input signal range is set to "1 to 5V/4 to 20 mA" but the input is less than 1 V/4 mA.</li> </ul> </li> <li>• <b>Disconnect indications</b> <ul style="list-style-type: none"> <li>• BROKEN WIRE indicator is lit.</li> <li>• The Input Disconnect Flag (IR n+9, bits 00 to 07) that corresponds to the input signal is turned ON. (Bits 00 to 07 correspond to inputs 1 to 8.)</li> </ul> </li> </ul>	<p>Check the input signal wires and connector wiring for broken wires or disconnections.</p> <p>Check the input voltage and current.</p> <p>Turn ON the corresponding conversion prohibit bits (DM m, bits 00 to 07) for any unused inputs. (Bits 00 to 07 correspond to inputs 1 to 8.)</p>
Limit warning	<ul style="list-style-type: none"> <li>• <b>Causes of error</b> <ul style="list-style-type: none"> <li>• The output data (conversion data or calculation result) isn't within the preset limits.</li> </ul> </li> <li>• <b>Limit warning indications</b> <ul style="list-style-type: none"> <li>• The Limit Warning Flag (IR n+9, bits 08 to 15) that corresponds to the input signal is turned ON. (Bits 08 to 15 correspond to inputs 1 to 8.)</li> </ul> </li> </ul>	<p>Check the input signal value.</p> <p>Check whether the upper- and lower-limit values are appropriate.</p>
RUN indicator not lit	The RUN indicator on the Unit is not lit even though power is turned on to the PC, and none of the errors described in this table have occurred.	Replace the Unit.

CPU error	Probable causes and operations	Possible remedies
CPU waiting	<ul style="list-style-type: none"> <li>• The Special I/O Unit is defective.</li> <li>• The PC hasn't begun to run.</li> </ul>	<ul style="list-style-type: none"> <li>• Replace the defective Special I/O Unit.</li> <li>• The defective Unit should appear as \$ signs only in the I/O table read operation.</li> </ul>
I/O Unit Over error	<ul style="list-style-type: none"> <li>• One unit number has been assigned to more than one Special I/O Unit.</li> <li>• SR 25415 will be turned ON and the PC won't operate when an "I/O Unit Over error" occurs. Flags AR 0000 to AR 0011 indicate the duplicated unit number.</li> </ul>	Do not assign the same number to more than one Unit. Use the I/O table read operation to display unit numbers.
Special I/O Unit error	<ul style="list-style-type: none"> <li>• An error has occurred in I/O refreshing between the CPU and the Special I/O Unit.</li> <li>• SR 25415 will be turned ON but PC operation will continue when a "Special I/O Unit error" occurs.</li> </ul>	Check AR 0000 to AR 00015 for the unit number of the Unit in error. After correcting the error, restart the Unit by toggling the corresponding restart bit (OFF → ON → OFF) in AR 0100 to AR 0109. If the error recurs after restarting the Unit, replace the Unit.

### Special I/O Unit Error Detection Bit (SR)

Bit	Error	Explanation	Operation status
SR 25415	Duplicated unit number	The same number is assigned to more than one Special I/O Unit.	PC operation stops.
	Special I/O Unit error	An error has occurred in the refresh signal between the CPU and the Special I/O Unit	Operation stops only for the faulty Unit.

**Special I/O Unit Error Flags (AR)**

Bit	Item	Function
AR 0000	Unit #0 Error Flag	When one of the CPU errors described above occurs, the AR bit turns ON for the Unit where the error occurred.
AR 0001	Unit #1 Error Flag	
AR 0002	Unit #2 Error Flag	
AR 0003	Unit #3 Error Flag	
AR 0004	Unit #4 Error Flag	
AR 0005	Unit #5 Error Flag	
AR 0006	Unit #6 Error Flag	
AR 0007	Unit #7 Error Flag	
AR 0008	Unit #8 Error Flag	
AR 0009	Unit #9 Error Flag	

**Note** SR 28200 to SR 28215 can also be used for unit numbers 0 to 15 for the C200HX/HG/HE.

**Special I/O Unit Restart Bits (AR)**

Turn OFF → ON → OFF the Special I/O Unit Restart Bits in the following circumstances:

- After DM data has been set or replaced.
- To restart Unit operation after clearing an error.

The same effect can be achieved by turning off the power to the PC and then turning it on again.

Bit	Item	Function
AR 0100	Unit #0 Restart Bit	Special I/O Units can be restarted by turning the corresponding bits OFF → ON → OFF.
AR 0101	Unit #1 Restart Bit	
AR 0102	Unit #2 Restart Bit	
AR 0103	Unit #3 Restart Bit	
AR 0104	Unit #4 Restart Bit	
AR 0105	Unit #5 Restart Bit	
AR 0106	Unit #6 Restart Bit	
AR 0107	Unit #7 Restart Bit	
AR 0108	Unit #8 Restart Bit	
AR 0109	Unit #9 Restart Bit	

**Note** SR 28100 to SR 28115 can also be used for unit numbers 0 to 15 for the C200HX/HG/HE.

# SECTION 3

## C200H-DA002 Analog Output Units

This section provides the information required to install and operate a C200H-DA002 Analog Output Unit.

3-1	Before Operation .....
3-1-1	Nomenclature and Functions .....
3-1-2	Switch Settings .....
3-1-3	Wiring .....
3-2	Bit and DM Allocations .....
3-2-1	Programming .....
3-3	Troubleshooting .....

### 3-1 Before Operation

#### 3-1-1 Nomenclature and Functions

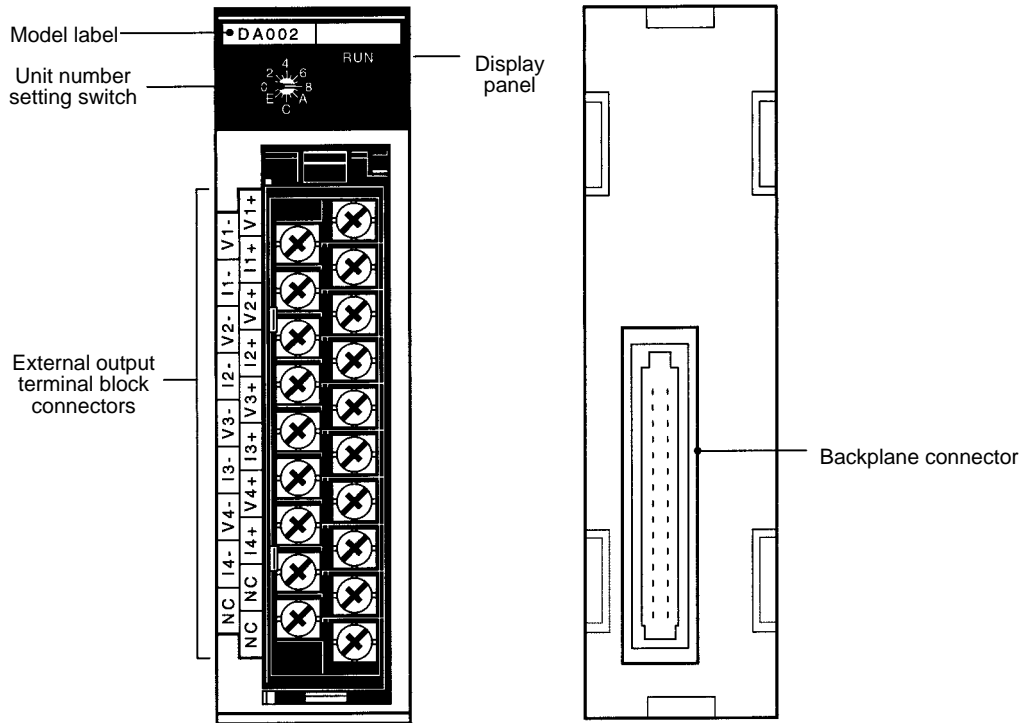

#### Indicators

Indicator	Color	Function
RUN	Green	Lit when the Analog Input Unit is operating correctly. If operation is not normal, this indicator turns OFF and Unit operation is stopped.

**Block Diagram**

The following diagram shows the basic internal configuration of the Analog Output Unit.

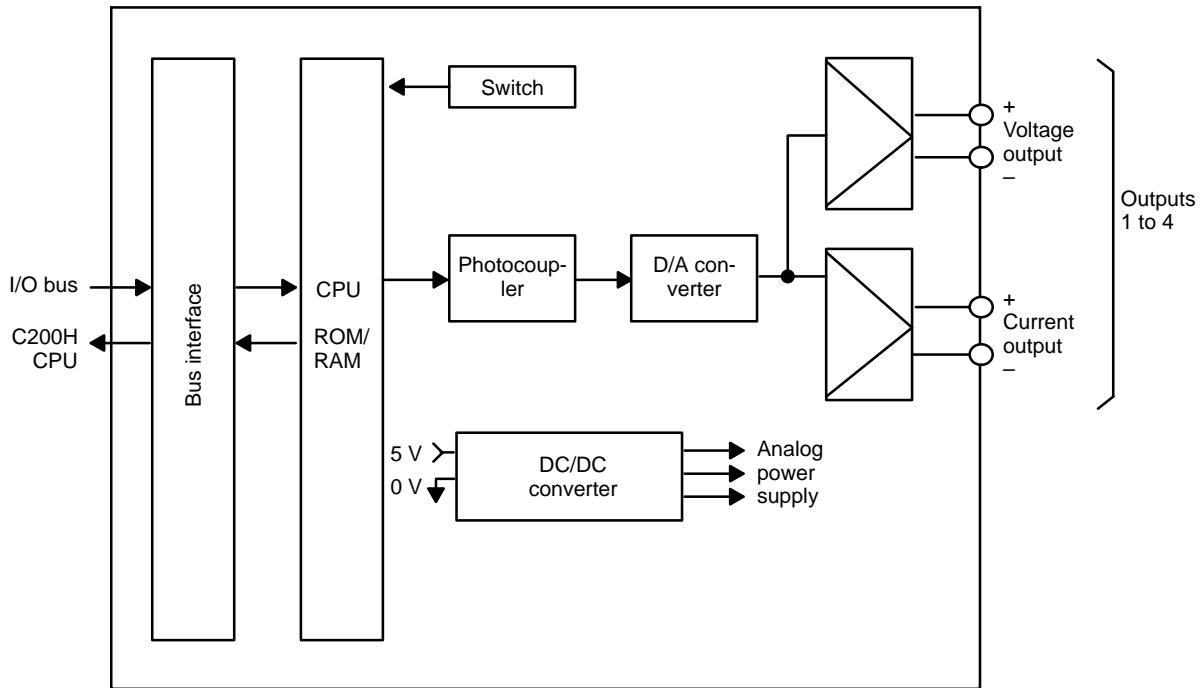

**3-1-2 Switch Settings**

**Unit Number**

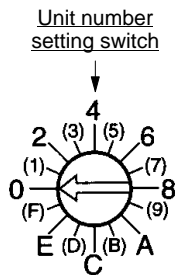

The switch notch points to the unit number. The switch in the figure to the left is set to 0. Odd numbers, in parentheses here, are not shown on the Unit.

Use a standard screwdriver to set a different unit number for each Analog I/O Unit. IR area memory is allocated according to unit number, as shown in the table below.

Switch number	Unit number	IR words
0	Unit #0	IR 100 to 109
1	Unit #1	IR 110 to 119
2	Unit #2	IR 120 to 129
3	Unit #3	IR 130 to 139
4	Unit #4	IR 140 to 149
5	Unit #5	IR 150 to 159
6	Unit #6	IR 160 to 169
7	Unit #7	IR 170 to 179
8	Unit #8	IR 180 to 189
9	Unit #9	IR 190 to 199
A	Unit #10	IR 400 to 409
B	Unit #11	IR 410 to 419
C	Unit #12	IR 420 to 429
D	Unit #13	IR 430 to 439
E	Unit #14	IR 440 to 449
F	Unit #15	IR 450 to 459

- Note**
1. The unit number setting switch is factory set to 0.
  2. If two or more Special I/O Units are assigned the same unit number, an I/O UNIT OVER error will be generated and the PC will not operate.
  3. Make the unit number settings with the power turned off to the PC. If the settings are made with the power on, they will not go into effect until either the power is turned off and then on again or the Special I/O Unit Restart Flag (AR0100 to AR0109) is turned OFF → ON → OFF.
  4. The unit number can be set to between A and F Hex (10 to 15 decimal) only when a C200H-DA002 with a lot number □□16 or later (January 1996 or later) is used with a C200HG-CPU53/CPU63 or C200HX-CPU54/CPU64 CPU Unit.

### 3-1-3 Wiring

#### Terminal Allocation

The following illustration shows the function of each output.

Voltage output 1 (-)	A0	B0	Voltage output 1 (+)
Current output 1 (-)	A1	B1	Current output 1 (+)
Voltage output 2 (-)	A2	B2	Voltage output 2 (+)
Current output 2 (-)	A3	B3	Current output 2 (+)
Voltage output 3 (-)	A4	B4	Voltage output 3 (+)
Current output 3 (-)	A5	B5	Current output 3 (+)
Voltage output 4 (-)	A6	B6	Voltage output 4 (+)
Current output 4 (-)	A7	B7	Current output 4 (+)
Not used.	A8	B8	Not used.
		B9	Not used.

Output Wiring

The following diagram shows the external wiring of outputs for the C200H-DA002.

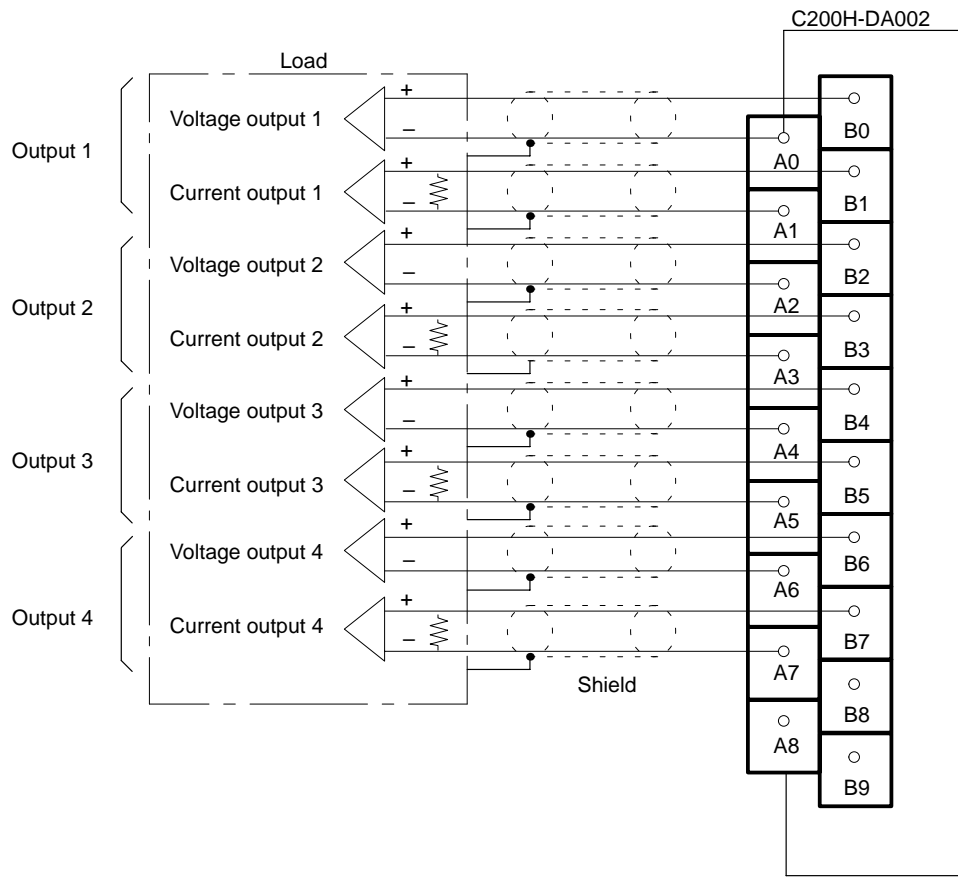

**Note** A single output line cannot be used for voltage and current output at the same time.



**Output Wiring Considerations**

When wiring outputs, apply the following points to avoid noise interference and optimize Analog Output Unit performance.

- Use shielded twisted-pair cable for external connections and power lines.
- Route output cables separately from the AC cable, and do not run the Unit's cables near a main circuit cable, high voltage cable, or a non-PC load cable.
- Be sure to install surge-absorbing diodes or surge absorbers for inductive loads (relays, solenoids, electromagnetic valves, etc.) They should be installed right next to relays and solenoids. Use surge-absorbing diodes with a dielectric strength of at least five times the circuit voltage.

DC Relay

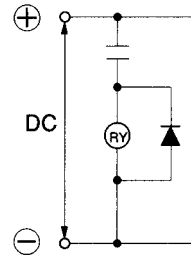

Surge-absorbing diode  
(Example: ERB44-06,  
by Fuji Electric)

AC Relay

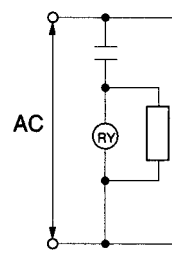

Surge absorber  
(Example: CR-50500,  
by Okaya Electric)

Solenoid, etc.

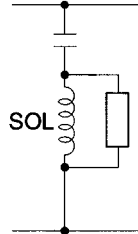

Surge absorber  
(Example: CR-50500,  
by Okaya Electric)

- If there is noise interference from power lines (if, for example, the power supply is shared with electrical welding devices or electrical discharge machines, or if there is a high-frequency generation source nearby) install a noise filter at the power supply output area.
- Connect to a ground of 100 Ω or less, with as heavy a wire as possible (i.e., at least 1.25 mm<sup>2</sup>).

### 3-2 Bit and DM Allocations

#### IR Allocations

The Analog Output Units are allocated ten words each from the portion of the IR area (IR 100 to IR 199) that is reserved for Special I/O Units. The words that are allocated a particular Analog Output Unit depend on the setting of the unit number setting switch on the front panel of the Unit. Those ten words are then reserved as an I/O refresh data area, and the bits that comprise that area are refreshed with every I/O refresh cycle by the PC.

SYSMAC C200HS, C200H, C200HX/HG/HE

C200H-DA002 Analog Output Unit

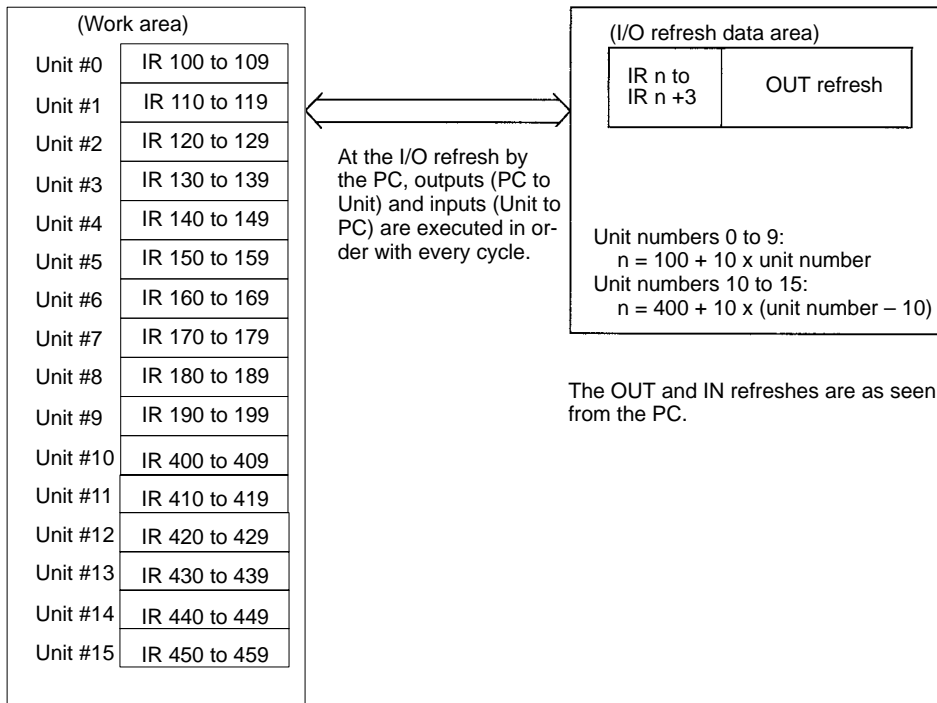

The OUT and IN refreshes are as seen from the PC.

- Note**
1. The unit number that is set for an Analog Output Unit must not be used for any other Special I/O Unit. If overlapping numbers are set, an I/O UNIT OVER error will be generated and operation will be stopped.
  2. The unit number can be set to between A and F Hex (10 to 15 decimal) only when a C200H-AD002 with a lot number □□16 or later (January 1996 or later) is used with a C200HG-CPU53/CPU63 or C200HX-CPU54/CPU64 CPU Unit.

#### IR Allocations

Unit numbers 0 to 9:  $n = 100 + 10 \times \text{unit number}$   
 Unit numbers 10 to 15:  $n = 400 + 10 \times (\text{unit number} - 10)$

I/O	Wd (IR)	Bit															
		15	14	13	12	11	10	09	08	07	06	05	04	03	02	01	00
OUT	n	Sign bit	Output 1 setting data														
	n+1	Sign bit	Output 2 setting data														
	n+2	Sign bit	Output 3 setting data														
	n+3	Sign bit	Output 4 setting data														

#### Setting Data

Output signal range	Setting data (BCD equivalent shown in parentheses)
+4 to +20 mA	0000 to 0FFF (0000 to 4095)
-10 to +10 V	8FFF to 8001, 0000 to 0FFF (-4095 to -0001, 0000 to 4095)

**Note** When the -10 to +10 V range is being used, the 15<sup>th</sup> bit serves as the sign bit. A value of 0 indicates “+” and a value of 1 indicates “-.”

### 3-2-1 Programming

Use the MOV(21) instruction to write output data (binary data) from the CPU to the Analog Output Unit.

#### Word Allocation

This program example uses the following settings:

- Unit number: 0 (Words IR 100 to IR 103 are allocated to unit number 0.)
- The following table shows the DM words that contain the output data.

Output number	DM word
Output 1	DM 0000
Output 2	DM 0001
Output 3	DM 0002
Output 4	DM 0003

#### Program Example

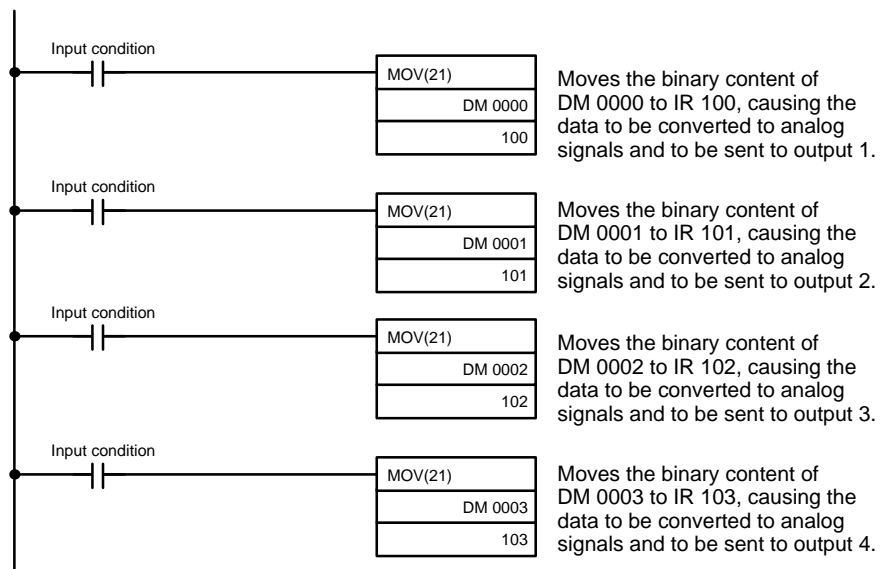

## 3-3 Troubleshooting

#### Error Detection

When an error occurs in an input or in the Unit itself, the error is indicated by an output to a flag in the IR, SR, or AR area. The following tables show the various errors that may occur, along with their probable causes and remedies.

Unit error	Probable causes and operations	Possible remedies
RUN indicator not lit	The RUN indicator on the Unit is not lit even though power is turned on to the PC, and none of the errors described in this table have occurred.	Replace the Unit.

CPU error	Probable causes and operations	Possible remedies
CPU waiting	<ul style="list-style-type: none"> <li>The Special I/O Unit is defective.</li> <li>The PC hasn't begun to run.</li> </ul>	<ul style="list-style-type: none"> <li>Replace the defective Special I/O Unit.</li> <li>The defective Unit should appear as \$ signs only in the I/O table read operation.</li> </ul>
I/O Unit Over error	<ul style="list-style-type: none"> <li>One unit number has been assigned to more than one Special I/O Unit.</li> <li>SR 25415 will be turned ON and the PC won't operate when an "I/O Unit Over error" occurs. Flags AR 0000 to AR 0011 indicate the duplicated unit number.</li> </ul>	Do not assign the same number to more than one Unit. Use the I/O table read operation to display unit numbers.
Special I/O Unit error	<ul style="list-style-type: none"> <li>An error has occurred in I/O refreshing between the CPU and the Special I/O Unit.</li> <li>SR 25415 will be turned ON but PC operation will continue when a "Special I/O Unit error" occurs.</li> </ul>	Check AR 0000 to AR 0015 for the unit number of the Unit in error. After correcting the error, restart the Unit by toggling the corresponding restart bit (OFF → ON → OFF) in AR 0100 to AR 0109. If the error recurs after restarting the Unit, replace the Unit.

**Special I/O Unit Error Detection Bit (SR)**

Bit	Error	Explanation	Operation status
25415	Duplicated unit number	One number is assigned to more than one Special I/O Unit.	PC operation stops.
	Special I/O Unit error	An error has occurred in the refresh signal between the CPU and the Special I/O Unit	Operation stops only for the faulty Unit.

**Special I/O Unit Error Flags (AR)**

Bit	Item	Function
AR 0000	Unit #0 Error Flag	When one of the CPU errors described above occurs, the AR bit turns ON for the Unit where the error occurred.
AR 0001	Unit #1 Error Flag	
AR 0002	Unit #2 Error Flag	
AR 0003	Unit #3 Error Flag	
AR 0004	Unit #4 Error Flag	
AR 0005	Unit #5 Error Flag	
AR 0006	Unit #6 Error Flag	
AR 0007	Unit #7 Error Flag	
AR 0008	Unit #8 Error Flag	
AR 0009	Unit #9 Error Flag	

**Note** SR 28200 to SR 28215 can also be used for unit numbers 0 to 15 for the C200HX/HG/HE.

**Special I/O Unit Restart Bits (AR)**

Turn OFF → ON → OFF the Special I/O Unit Restart Bits in the following circumstances:

- After DM data has been set or replaced.
- To restart Unit operation after clearing an error.

The same effect can be achieved by turning ON → OFF → ON the power to the PC and then turning it on again.

Bit	Item	Function
AR 0100	Unit #0 Restart Bit	Special I/O Units can be restarted by turning the corresponding bits OFF → ON → OFF.
AR 0101	Unit #1 Restart Bit	
AR 0102	Unit #2 Restart Bit	
AR 0103	Unit #3 Restart Bit	
AR 0104	Unit #4 Restart Bit	
AR 0105	Unit #5 Restart Bit	
AR 0106	Unit #6 Restart Bit	
AR 0107	Unit #7 Restart Bit	
AR 0108	Unit #8 Restart Bit	
AR 0109	Unit #9 Restart Bit	

**Note** SR 28100 to SR 28115 can also be used for unit numbers 0 to 15 for the C200HX/HG/HE.

# Appendix A

## Standard Models

### Analog Input Unit

PC	Model
C200H, C200HS, C200HX/HG/HE	C200H-AD002

### Analog Output Unit

PC	Model
C200H, C200HS, C200HX/HG/HE	C200H-DA002

# Appendix B

## Specifications

### C200H-AD002 Analog Input Unit

#### General Specifications

All general specifications of the C200H-AD002 Analog Input Unit conform to those of the C Series.

#### Performance Specifications

Item	Specifications		
<b>Number of analog inputs</b>	8 max.		
<b>Input signal range (note 1)</b>	Voltage input	-10 to +10 V	Set for each input number in the allocated DM area.
		+1 to +5 V	
		0 to 10 V	
	Current input	4 to 20 mA	
<b>Max. input signal (note 2)</b>	Voltage input	±15 V	
	Current input	±30 mA	
<b>Input impedance</b>	Voltage input	1 MΩ min.	
	Current input	250 Ω (rated value)	
<b>Resolution</b>	1/4000 max. (full scale)		
<b>Converted output data (note 3)</b>	Binary data	±10 V range: 87D0 to 07D0 Other ranges: 0000 to 0FA0	
	BCD data	±10 V range: A000 to 2000 Other ranges: 0000 to 4000	
<b>Accuracy (note 4)</b>	25°C	Voltage input: ±0.25% (full scale) Current input: ±0.40% (full scale)	
	0° to 55°C	Voltage input: ±0.60% (full scale) Current input: ±0.80% (full scale)	
<b>Conversion time (note 5)</b>	2.5 ms max./point		
<b>Isolation</b>	Between input terminals and PC: photocoupler		
	Between input terminals: none		
<b>External connectors</b>	34-pin connector (Honda Communications Industries) Connector for the cable side (One is included with each Unit.)		
	MR-34LFG Set	Connector: MR-34FG Cover: MR-34L	
<b>Power consumption</b>	450 mA max. at 5 VDC		
<b>Dimensions</b>	34.5 x 130 x 109 (W x H x D) mm (see last page of this appendix)		
<b>Weight</b>	290 g		

- Note**
- When the input range is set to -10 V to +10 V, the most significant bit (15<sup>th</sup> bit) becomes the sign bit.
  - Operation in ranges beyond the maximum input signals will damage the Unit. Operate within the ranges listed above.
  - The accuracy is given for full scale (4000). For example, an accuracy of ±0.80% means a maximum error of ±32 (BCD).
  - This is the time it takes for a full range input signal to be converted and to be stored in the memory of the Unit. It takes at least one cycle before the converted data is read by the CPU.

## Input Specifications

Converted output data  
 (Top: Binary  
 Parentheses: BCD)

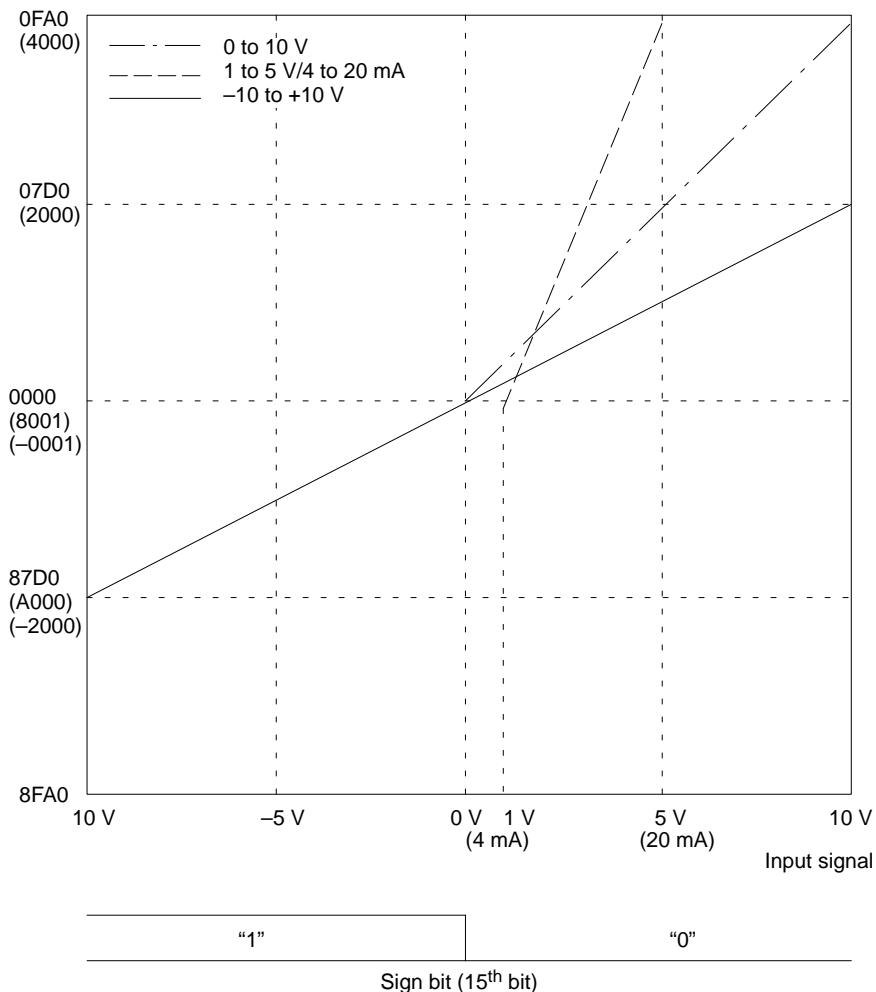

- Note**
1. The input signal range (0 to +10 V, +1 to +5 V/+4 to +20 mA, or -10 to +10 V) can be selected for each input number. Refer to *2-3 Functions and Programming* for details on setting the input signal range.
  2. If an analog signal is input that exceeds the input signal range (max. value of +10 V or +5 V/20 mA, or min. value of 0 V, +1 V/4 mA, or -10 V), the digital output will remain fixed at the maximum or minimum value.
  3. When the input range is set to -10 V to +10 V, the most significant bit (15<sup>th</sup> bit) becomes the sign bit.
  4. When the input range is set to -10 V to +10 V and the analog input signal is 0 V, the digital output will be "0000" and the most significant bit (15<sup>th</sup> bit) will be 0.



## C200H-DA002 Analog Output Unit

All general specifications of the C200H-DA002 Analog Output Unit conform to those of the C Series.

Item	Specifications	
<b>Number of analog outputs</b>	4	
<b>Output signal range</b>	Voltage outputs	-10 to +10 V
	Current outputs	4 to 20 mA
<b>Max. output impedance</b>	Voltage output: 0.5 $\Omega$	
<b>Max. output current</b>	Voltage output: 10 mA	
<b>Max. load resistance</b>	Current output: 350 $\Omega$	
<b>Resolution</b>	Voltage outputs	1/8190 max. (full scale)
	Current outputs	1/4095 max. (full scale)
<b>Set data</b>	Voltage output: Sign bit +12-bit binary (8FFF to 0FFF) Current output: 12-bit binary (0000 to 0FFF)	
<b>Accuracy</b>	25°C	Voltage outputs: $\pm 0.3\%$ max. (full scale) Current outputs: $\pm 0.5\%$ max. (full scale)
	0° to 55°C	Voltage outputs: $\pm 0.5\%$ max. (full scale) Current outputs: $\pm 1.0\%$ max. (full scale)
<b>Conversion time (see Note)</b>	2.5 ms max./point	
<b>Isolation</b>	Between output terminals and PC: photocoupler	
	Between output terminals: none	
<b>External connections</b>	19-pin terminal block (removable)	
<b>Power consumption</b>	600 mA max. at 5 VDC	
<b>Dimensions</b>	34.5 x 130 x 128 (W x H x D) mm (see last page of this appendix)	
<b>Weight</b>	320 g max.	

**Note** This is the time from after the data has been written to the Unit until an analog output appears. The output data will not be correct if output data is rewritten faster than it can be output.

# Output Specifications

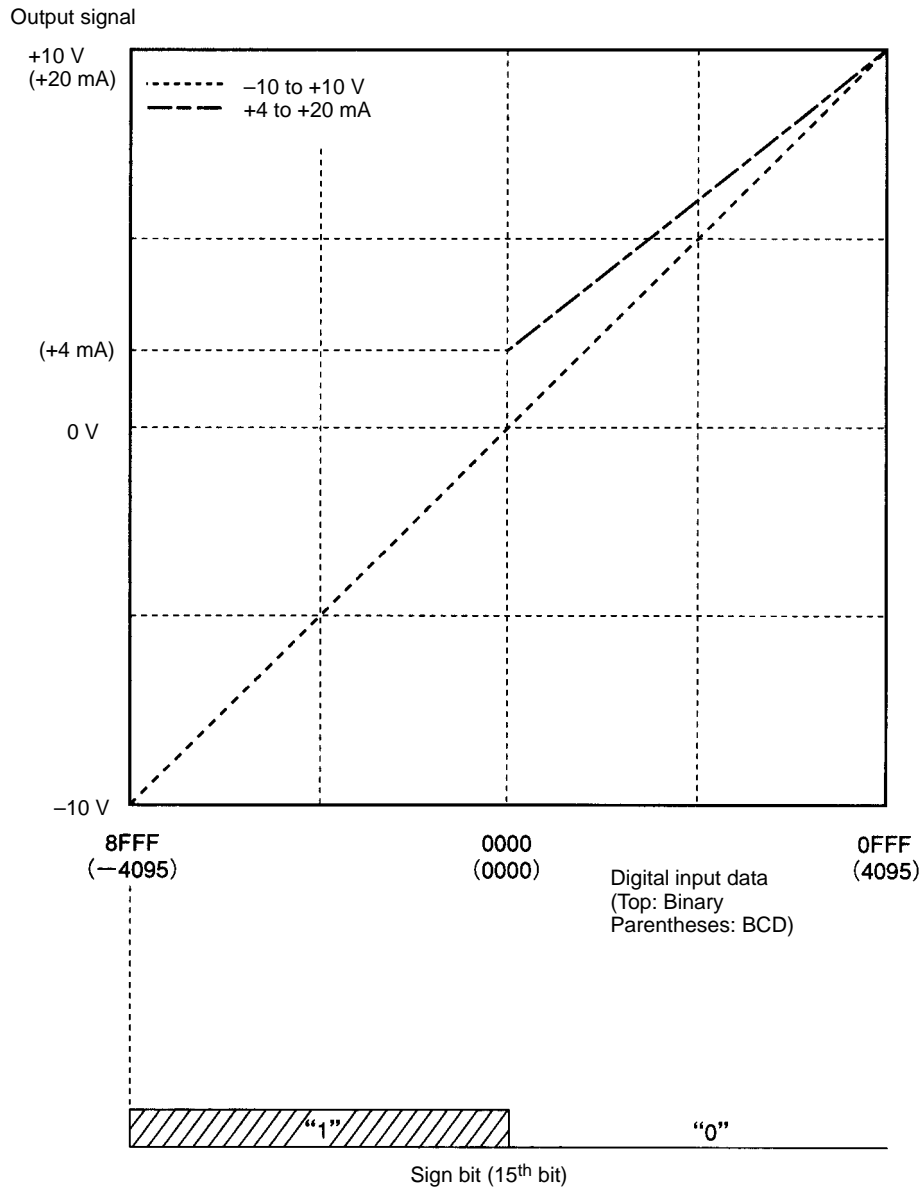

- Note**
1. If a digital signal is input that exceeds the output signal range (max. value of +10 V or +20 mA, or min. value of -10 V or +4 mA), the analog output will remain fixed at its maximum or minimum value.
  2. When the input range is set to -10 V to +10 V, the most significant bit (15<sup>th</sup> bit) becomes the sign bit.

## External Dimensions

Unit: mm

### C200H-AD002 Analog Input Unit

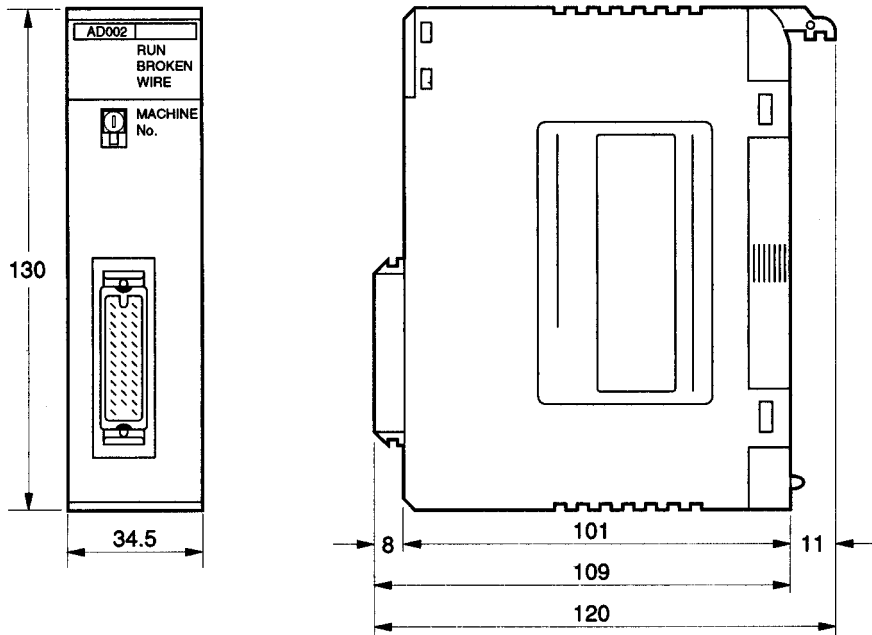

### C200H-DA002 Analog Output Unit

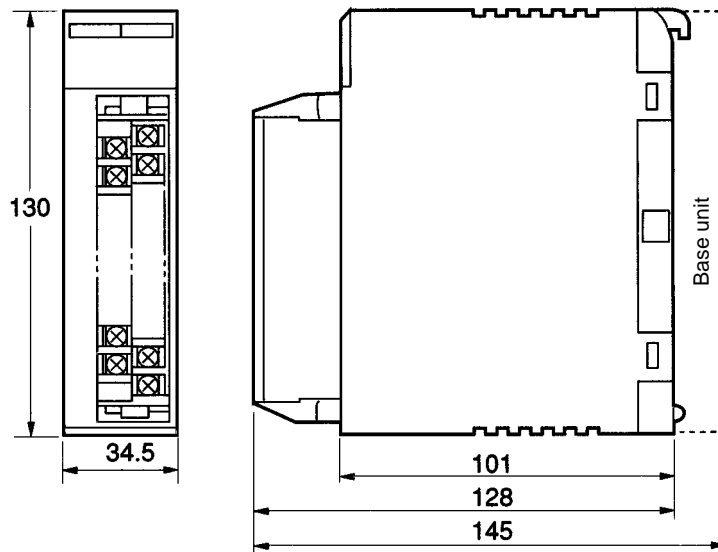

# Installation Dimensions (Unit: mm)

## C200H-AD002 Analog Input Unit

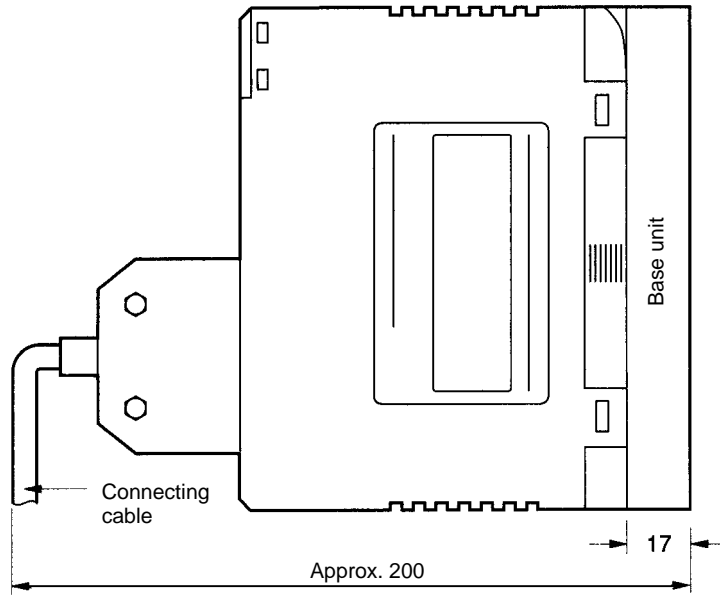

# Appendix C

## Data Memory Coding Sheet

### C200H-AD002 Analog Input Unit

#### Data Settings

C200H-AD002		Unit number: _____							
Item		Input 8	Input 7	Input 6	Input 5	Input 4	Input 3	Input 2	Input 1
Conversion prohibit setting									
A/D conversion data		Binary or BCD							
Input signal range									
Scaling function	Lower limit								
	Upper limit								
Number of terms for mean value calculation									
Square root function									
Limit warning function	Mode	1 or 2							
	Lower limit								
	Upper limit								

## Data Memory Coding Sheet

C200H-AD002				Unit number: _____ DM1_00 to DM1_43	
DM address (rightmost digits)	Data			Usage	
00	0			Bit 09: Limit warning mode (Mode 2 = 1) Bit 08: Data type setting (BCD = 1)	Conversion prohibit setting (prohibit = 1)
01				Input signal range (00 specifies -10 to +10 V, 01 specifies 0 to 10 V, and 10 specifies 1 to 5 V/4 to 20 mA.)	
02				Scaling execution	Mean value execution
03				Square root execution	Limit warning execution
04				Input 1 scaling: lower-limit value	
05				Input 1 scaling: upper-limit value	
06				Input 2 scaling: lower-limit value	
07				Input 2 scaling: upper-limit value	
08				Input 3 scaling: lower-limit value	
09				Input 3 scaling: upper-limit value	
10				Input 4 scaling: lower-limit value	
11				Input 4 scaling: upper-limit value	
12				Input 5 scaling: lower-limit value	
13				Input 5 scaling: upper-limit value	
14				Input 6 scaling: lower-limit value	
15				Input 6 scaling: upper-limit value	
16				Input 7 scaling: lower-limit value	
17				Input 7 scaling: upper-limit value	
18				Input 8 scaling: lower-limit value	
19				Input 8 scaling: upper-limit value	
20				Input 1 mean value processing: number of samples	
21				Input 2 mean value processing: number of samples	
22				Input 3 mean value processing: number of samples	
23				Input 4 mean value processing: number of samples	
24				Input 5 mean value processing: number of samples	
25				Input 6 mean value processing: number of samples	
26				Input 7 mean value processing: number of samples	

C200H-AD002				Unit number: _____ DM1_00 to DM1_43
DM address (rightmost digits)	Data			Usage
27				Input 8 mean value processing: number of samples
28				Input 1 limit warning: lower-limit value
29				Input 1 limit warning: upper-limit value
30				Input 2 limit warning: lower-limit value
31				Input 2 limit warning: upper-limit value
32				Input 3 limit warning: lower-limit value
33				Input 3 limit warning: upper-limit value
34				Input 4 limit warning: lower-limit value
35				Input 4 limit warning: upper-limit value
36				Input 5 limit warning: lower-limit value
37				Input 5 limit warning: upper-limit value
38				Input 6 limit warning: lower-limit value
39				Input 6 limit warning: upper-limit value
40				Input 7 limit warning: lower-limit value
41				Input 7 limit warning: upper-limit value
42				Input 8 limit warning: lower-limit value
43				Input 8 limit warning: upper-limit value

# Index

## A–B

A/D conversion data,  
BCD data, data type setting,  
binary data, data type setting,  
block diagram, C200H-DA002,  
BROKEN WIRE indicator,

## C

cable shield,  
configurations, system,  
  considerations,  
connector, wiring methods,  
conversion, prohibiting,  
conversion data type setting,  
conversion prohibit settings,  
conversion prohibition,

## D

data memory coding sheet,  
data type setting,  
dimensions  
  external,  
  installation,  
disconnection detection,  
DM area allocation, C200H-AD002, ,  
DM area contents, C200H-AD002,

## E–F

error detection  
  C200H-AD002,  
  C200H-DA002,  
field devices,  
flags  
  input disconnect,  
  limit warning,

## I

indicators  
  C200H-AD002,  
  C200H-DA002,  
Input Disconnect Flags,

input disconnection detection function,  
input signal range setting,

IR area allocation  
  C200H-AD002, ,  
  C200H-DA002,

IR area contents, C200H-AD002,

## L–M

limit warning flags,  
limit warning function,  
MACHINE No.. *See* unit number  
mean value function,  
models,

## P

peak value function,  
precautions, , ,  
  applications,  
  general,  
  operating environment,  
  safety,  
programming examples  
  C200H-AD002,  
  C200H-DA002,  
protective seal,

## S–T

scaling function,  
Slave Racks,  
specifications,  
square root function,  
switches  
  C200H-AD002,  
  C200H-DA002,  
troubleshooting  
  C200H-AD002,  
  C200H-DA002,

## U–W

unit numbers, setting  
  C200H-AD002,  
  C200H-DA002,  
Units, number,  
wiring  
  C200H-AD002,  
  C200H-DA002,



